

MHI

Manual No. '06-SRK-T-060

TECHNICAL MANUAL

Collection data

INVERTER WALL MOUNTED TYPE ROOM AIR-CONDITIONER (Split system, air to air heat pump type)

SRK20ZG-S, SRK25ZG-S, SRK35ZG-S, SRK50ZG-S

CONTENTS

1 GENERAL INFORMATION	1
1.1 Specific features.....	1
1.2 How to read the model name	1
2 SELECTION DATA	2
2.1 Specifications	2
2.2 Range of usage & limitations	6
2.3 Exterior dimensions	6
2.4 Piping system	8
2.5 Selection chart	9
3 ELECTRICAL DATA	10
3.1 Electrical wiring.....	10
4 OUTLINE OF OPERATION CONTROL BY MICROCOMPUTER	12
4.1 Operation control function by remote control switch.....	12
4.2 Unit ON/OFF button.....	13
4.3 Power blackout auto restart function	13
4.4 Custom cord switching procedure	13
4.5 Flap and louver control.....	14
4.6 3D auto operation.....	15
4.7 Timer operation	16
4.8 Installation location setting	16
4.9 Outline of heating operation	17
4.10 Outline of cooling operation	18
4.11 Outline of automatic operation	18
4.12 Protective control function.....	19
5 APPLICATION DATA	24
5.1 Selection of location for installation	25
5.2 Installation of indoor unit	26
5.3 Installation of outdoor unit.....	29
5.4 Connection of refrigerant pipings	29
5.5 Test run	31
5.6 Precautions for wireless remote control installation and operation	31

6	MAINTENANCE DATA	32
6.1	Troubleshooting procedures for electrical equipment	32
6.2	Servicing	51
7	INTERFACE KIT (OPTIONAL PARTS).....	52
7.1	Applicable model.....	52
7.2	List of connectable devices	52
7.3	Exterior dimensions	52
7.4	Circuit board component layout	52
7.5	System configuration.....	53
7.6	Installation of interface kit.....	54
7.7	Wired remote control	59
7.8	Insatallation of wired remote control	60
7.9	Setting functions using the wired remote control	61
7.10	Super link adapter	65
7.11	Operation permission/prohibition control	67
7.12	External control (remote display) /control of input signal.....	68
8	REFRIGERANT PIPING INSTALLATION / SERVICING MANUAL	
	FOR AIR CONDITIONERS USING R410A.....	69
8.1	Outline	69
8.2	Refrigerant piping installation	70
8.3	Installation, removal and servicing.....	76
8.4	Refrigerant recovery	81

1 GENERAL INFORMATION

1.1 Specific features

The “MITSUBISHI HEAVY INDUSTRIES, LTD” room air-conditioner: SRK series are of split and wall mounted type and the unit consists of indoor unit and outdoor unit with refrigerant precharged in factory. The indoor unit is composed of room air cooling or heating equipment with operation control switch and the outdoor unit is composed of condensing unit with compressor.

(1) Inverter (Frequency converter) for multi-steps power control

- Heating/Cooling

The rotational speed of a compressor is changed in step in relation to varying load, interlocked with the indoor and outdoor unit fans controlled to change frequency, thus controlling the capacity.

- Allowing quick heating/cooling operation during start-up period. Constant room temperature by fine-tuned control after the unit has stabilized.

(2) Fuzzy control

- Fuzzy control calculates the amount of variation in the difference between the return air temperature and the setting temperature in compliance with the fuzzy rules in order to control the air capacity and the inverter frequency.

(3) Remote control flap & louver

The flap & louver can be automatically controlled by operating wireless remote control.

- Flap swing : The flaps swing up and down successively.
- Louver swing : The louvers swing left and right successively.
- 3D auto operation : Fan speed and air flow direction are automatically controlled, allowing the entire room to be efficiently conditioned.
- Memory flap : Once the flap & louver position is set, the unit memorizes the position and continues to operate at the same position from the next time.

(4) Self diagnosis function

- We are constantly trying to do better service to our customers by installing such judges that show abnormality of operation as follows.

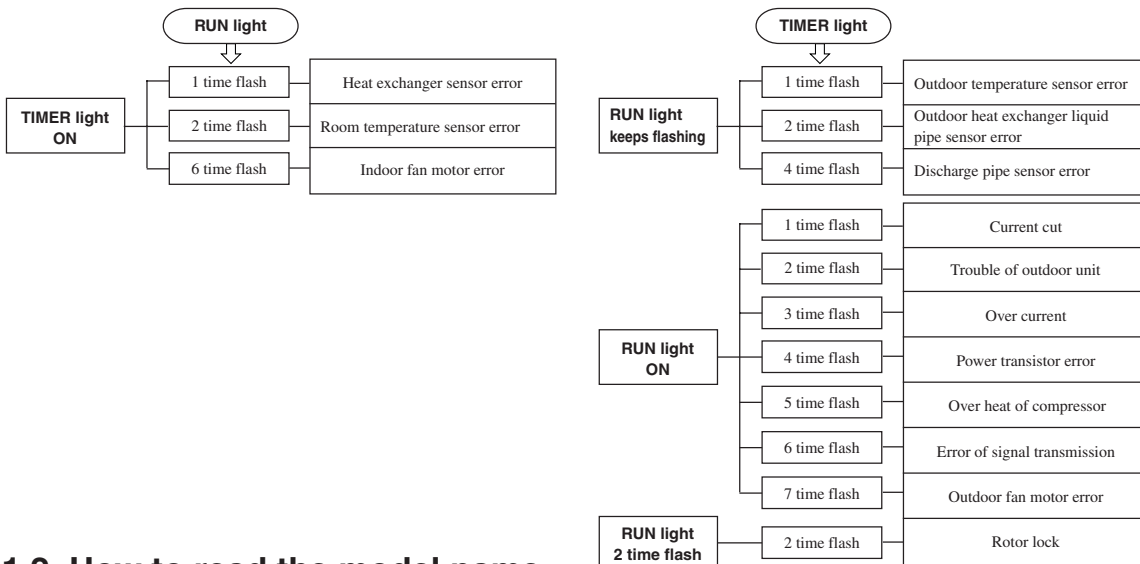

1.2 How to read the model name

Example :

SR K 35 Z G - S

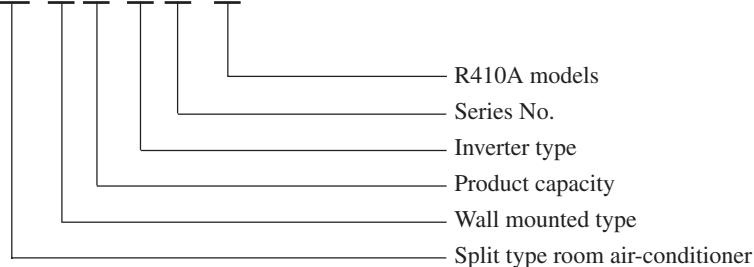

2 SELECTION DATA

2.1 Specifications

Model SRK20ZG-S (Indoor unit)
SRC20ZG-S (Outdoor unit)

(220/230/240V)

Item		Model	SRK20ZG-S	SRC20ZG-S	
Cooling capacity ⁽¹⁾		W	2000 (500~2800)		
Heating capacity ⁽¹⁾		W	2700 (500~4600)		
Power source			1 Phase, 220-240V, 50Hz		
Operation data ⁽¹⁾	Cooling input	kW	0.44 (0.1~0.91)		
	Running current (Cooling)	A	2.4/2.3/2.2		
	Heating input	kW	0.62 (0.09~1.27)		
	Running current (Heating)	A	3.0/2.9/2.8		
	Inrush current	A	3.0/2.9/2.8		
	COP			Cooling: 4.55 Heating: 4.35	
Noise level	Cooling	Sound level	Hi 35, Me 29, Lo 21	44	
		Power level	51	58	
	Heating	Sound level	Hi 35, Me 32, Lo 25	45	
		Power level	53	59	
Exterior dimensions		mm	268 × 790 × 199	540 × 780 × 290	
Height × Width × Depth					
Color			Fine snow	Stucco white	
Net weight		kg	8.5	35	
Refrigerant equipment				RM-B5077MD1 (Rotary type) × 1	
Compressor type & Q'ty			-		
Motor		kW	-	0.75	
Starting method			-	Line starting	
Heat exchanger			Louver fins & inner grooved tubing	Straight fins & inner grooved tubing	
Refrigerant control			Capillary tubes + Electronic expansion valve		
Refrigerant ⁽³⁾		kg	R410A 0.9 (Pre-Charged up to the piping length of 15m)		
Refrigerant oil		ℓ	0.35 (MA68)		
Deice control			Microcomputer control		
Air handling equipment					
Fan type & Q'ty			Tangential fan × 1	Propeller fan × 1	
Motor		W	38	24	
Air flow (at High)	(Cooling)	CMM	7.4	30	
	(Heating)		8.5	23	
Air filter, Q'ty			Polypropylene net (washable) × 2	-	
Shock & vibration absorber			-	Cushion rubber (for compressor)	
Electric heater			-	-	
Operation control			Wireless-Remote control	-	
Operation switch			-	-	
Room temperature control			Microcomputer thermostat	-	
Pilot lamp			RUN (Green), TIMER (Yellow), HI POWER (Green), 3D AUTO (Green)		
Safety equipment			Compressor overheat protection, Heating overload protection (High pressure control), Overcurrent protection, Frost protection, Serial signal error protection, Indoor fan motor error protection, Cooling overload protection		
Refrigerant piping	O.D	mm (in)	Liquid line: φ6.35 (1/4") Gas line: φ9.52 (3/8")		
	Connecting method		Flare connecting		
	Attached length of piping		Liquid line: 0.4 m	-	
	Insulation		Gas line : 0.33 m	Necessary (Both sides)	
Drain hose			Connectable		
Power source cord			2 m (3 cores with Earth)		
Connection wiring	Size × Core number		1.5 mm ² × 4 cores (Including earth cable)		
	Connecting method		Terminal block (Screw fixing type)		
Accessories (included)			Mounting kit, Clean filter (Allergen clear filter x1, Photocatalytic washable deodorizing filter x1)		
Optional parts			Interface kit		

Notes (1) The data are measured at the following conditions.

Operation	Item	Indoor air temperature		Outdoor air temperature		Standards
		DB	WB	DB	WB	
Cooling		27°C	19°C	35°C	24°C	ISO-T1, JIS C9612
Heating		20°C	-	7°C	6°C	ISO-T1, JIS C9612

The piping length is 7.5m.

- (2) The operation data are applied to the 220/230/240V districts respectively.
- (3) The refrigerant quantity to be charged includes the refrigerant in 15 m connecting piping.
(Purging is not required even for the short piping.)
- (4) If the interface kit (SC-BIK-E) (sold separately) is connected to the terminals on the indoor unit's circuit board, a wired remote control (sold separately) can be connected, a Super Link can be connected, and the unit can be turned on and off from a CNT terminal.

Model SRK25ZG-S (Indoor unit)
SRC25ZG-S (Outdoor unit)

(220/230/240V)

Item		Model	SRK25ZG-S	SRC25ZG-S	
Cooling capacity ⁽¹⁾		W	2500 (500~3000)		
Heating capacity ⁽¹⁾		W	3400 (500~4800)		
Power source			1 Phase, 220-240V, 50Hz		
Operation data ⁽¹⁾	Cooling input	kW	0.62 (0.1~0.97)		
	Running current (Cooling)	A	3.1/3.0/2.9		
	Heating input	kW	0.93 (0.09~1.30)		
	Running current (Heating)	A	4.5/4.3/4.1		
	Inrush current	A	4.5/4.3/4.1		
	COP			Cooling: 4.03 Heating: 3.66	
	Noise level	Cooling	Sound level	Hi 36, Me 30, Lo 22	44
Power level			52	58	
Heating		Sound level	Hi 36, Me 33, Lo 26	47	
		Power level	54	62	
Exterior dimensions Height × Width × Depth		mm	268 × 790 × 199	540 × 780 × 290	
Color			Fine snow	Stucco white	
Net weight		kg	8.5	35	
Refrigerant equipment Compressor type & Q'ty			-	RM-B5077MD1 (Rotary type) × 1	
Motor		kW	-	0.75	
Starting method			-	Line starting	
Heat exchanger			Louver fins & inner grooved tubing	Straight fins & inner grooved tubing	
Refrigerant control			Capillary tubes + Electronic expansion valve		
Refrigerant ⁽³⁾		kg	R410A 0.9 (Pre-Charged up to the piping length of 15m)		
Refrigerant oil		ℓ	0.35 (MA68)		
Deice control			Microcomputer control		
Air handling equipment Fan type & Q'ty			Tangential fan × 1	Propeller fan × 1	
Motor		W	38	24	
Air flow (at High)	(Cooling)	CMM	7.6	30	
	(Heating)		8.7	23	
Air filter, Q'ty			Polypropylene net (washable) × 2	-	
Shock & vibration absorber			-	Cushion rubber (for compressor)	
Electric heater			-	-	
Operation control Operation switch			Wireless-Remote control	-	
Room temperature control			Microcomputer thermostat	-	
Pilot lamp			RUN (Green), TIMER (Yellow), HI POWER (Green), 3D AUTO (Green)		
Safety equipment			Compressor overheat protection, Heating overload protection (High pressure control), Overcurrent protection, Frost protection, Serial signal error protection, Indoor fan motor error protection, Cooling overload protection		
Refrigerant piping	O.D	mm (in)	Liquid line: φ6.35 (1/4") Gas line: φ9.52 (3/8")		
	Connecting method		Flare connecting		
	Attached length of piping		Liquid line: 0.4 m Gas line : 0.33 m	-	
	Insulation		Necessary (Both sides)		
Drain hose		Connectable			
Power source cord		2 m (3 cores with Earth)			
Connection wiring	Size × Core number	1.5 mm ² × 4 cores (Including earth cable)			
	Connecting method	Terminal block (Screw fixing type)			
Accessories (included)		Mounting kit, Clean filter (Allergen clear filter x1, Photocatalytic washable deodorizing filter x1)			
Optional parts		Interface kit			

Notes (1) The data are measured at the following conditions.

Operation	Item	Indoor air temperature		Outdoor air temperature		Standards
		DB	WB	DB	WB	
Cooling		27°C	19°C	35°C	24°C	ISO-T1, JIS C9612
Heating		20°C	-	7°C	6°C	ISO-T1, JIS C9612

The piping length is 7.5m.

- (2) The operation data are applied to the 220/230/240V districts respectively.
- (3) The refrigerant quantity to be charged includes the refrigerant in 15 m connecting piping.
(Purging is not required even for the short piping.)
- (4) If the interface kit (SC-BIK-E) (sold separately) is connected to the terminals on the indoor unit's circuit board, a wired remote control (sold separately) can be connected, a Super Link can be connected, and the unit can be turned on and off from a CNT terminal.

Model SRK35ZG-S (Indoor unit)
SRC35ZG-S (Outdoor unit)

(220/230/240V)

Item		Model	SRK35ZG-S	SRC35ZG-S	
Cooling capacity ⁽¹⁾		W	3500 (500~3900)		
Heating capacity ⁽¹⁾		W	4200 (500~5100)		
Power source			1 Phase, 220-240V, 50Hz		
Operation data ⁽¹⁾	Cooling input	kW	1.05 (0.1~1.22)		
	Running current (Cooling)	A	4.9/4.7/4.5		
	Heating input	kW	1.14 (0.09~1.32)		
	Running current (Heating)	A	5.3/5.1/4.9		
	Inrush current	A	5.3/5.1/4.9		
	COP			Cooling: 3.33 Heating: 3.68	
	Noise level	Cooling	Sound level	Hi 40, Me 32, Lo 23	48
Power level			56	62	
Heating		Sound level	Hi 41, Me 36, Lo 27	50	
		Power level	59	64	
Exterior dimensions Height × Width × Depth		mm	268 × 790 × 199	540 × 780 × 290	
Color			Fine snow	Stucco white	
Net weight		kg	8.5	38	
Refrigerant equipment Compressor type & Q'ty			-	RM-B5077MD1 [Rotary type] × 1	
Motor		kW	-	0.90	
Starting method			-	Line starting	
Heat exchanger			Louver fins & inner grooved tubing	Straight fins & inner grooved tubing	
Refrigerant control			Capillary tubes + Electronic expansion valve		
Refrigerant ⁽³⁾		kg	R410A 1.1 (Pre-Charged up to the piping length of 15m)		
Refrigerant oil		ℓ	0.35 (MA68)		
Deice control			Microcomputer control		
Air handling equipment Fan type & Q'ty			Tangential fan × 1	Propeller fan × 1	
Motor		W	38	24	
Air flow (at High)	(Cooling)	CMM	8.5	30	
	(Heating)		10.8	33	
Air filter, Q'ty			Polypropylene net (washable) × 2	-	
Shock & vibration absorber			-	Cushion rubber (for compressor)	
Electric heater			-	-	
Operation control Operation switch			Wireless-Remote control	-	
Room temperature control			Microcomputer thermostat	-	
Pilot lamp			RUN (Green), TIMER (Yellow), HI POWER (Green), 3D AUTO (Green)		
Safety equipment			Compressor overheat protection, Heating overload protection (High pressure control), Overcurrent protection, Frost protection, Serial signal error protection, Indoor fan motor error protection, Cooling overload protection		
Refrigerant piping	O.D	mm (in)	Liquid line: φ6.35 (1/4") Gas line: φ9.52 (3/8")		
	Connecting method		Flare connecting		
	Attached length of piping		Liquid line: 0.4 m Gas line : 0.33 m	-	
	Insulation		Necessary (Both sides)		
Drain hose		Connectable			
Power source cord		2 m (3 cores with Earth)			
Connection wiring	Size × Core number	1.5 mm ² × 4 cores (Including earth cable)			
	Connecting method	Terminal block (Screw fixing type)			
Accessories (included)		Mounting kit, Clean filter (Allergen clear filter x1, Photocatalytic washable deodorizing filter x1)			
Optional parts		Interface kit			

Notes (1) The data are measured at the following conditions.

Operation	Item	Indoor air temperature		Outdoor air temperature		Standards
		DB	WB	DB	WB	
Cooling		27°C	19°C	35°C	24°C	ISO-T1, JIS C9612
Heating		20°C	-	7°C	6°C	ISO-T1, JIS C9612

The piping length is 7.5m.

- (2) The operation data are applied to the 220/230/240V districts respectively.
- (3) The refrigerant quantity to be charged includes the refrigerant in 15 m connecting piping.
(Purging is not required even for the short piping.)
- (4) If the interface kit (SC-BIK-E) (sold separately) is connected to the terminals on the indoor unit's circuit board, a wired remote control (sold separately) can be connected, a Super Link can be connected, and the unit can be turned on and off from a CNT terminal.

Model SRK50ZG-S (Indoor unit)
SRC50ZG-S (Outdoor unit)

(220/230/240V)

Item		Model	SRK50ZG-S	SRC50ZG-S	
Cooling capacity ⁽¹⁾		W	5000 (600~5300)		
Heating capacity ⁽¹⁾		W	5800 (600~7900)		
Power source			1 Phase, 220-240V, 50Hz		
Operation data ⁽¹⁾	Cooling input	kW	1.66 (0.12~2.1)		
	Running current (Cooling)	A	7.6/7.3/7.0		
	Heating input	kW	1.70 (0.11~2.71)		
	Running current (Heating)	A	7.9/7.5/7.2		
	Inrush current	A	7.9/7.5/7.2		
	COP			Cooling: 3.01 Heating: 3.41	
	Noise level	Cooling	Sound level	Hi 47, Me 42, Lo 26	48
Power level			61	61	
Heating		Sound level	Hi 48, Me 40, Lo 34	50	
		Power level	62	64	
Exterior dimensions Height × Width × Depth		mm	268 × 790 × 199	640 × 850 × 290	
Color			Fine snow	Stucco white	
Net weight		kg	8.5	43	
Refrigerant equipment Compressor type & Q'ty			–	5CS102XFA [Scroll type] × 1	
Motor		kW	–	1.5	
Starting method			–	Line starting	
Heat exchanger			Slit fins + Louver fins & inner grooved tubing	Straight fins & inner grooved tubing	
Refrigerant control			Capillary tubes + Electronic expansion valve		
Refrigerant ⁽³⁾		kg	R410A 1.35 (Pre-Charged up to the piping length of 15m)		
Refrigerant oil		ℓ	0.36 (RB68A)		
Deice control			Microcomputer control		
Air handling equipment Fan type & Q'ty			Tangential fan × 1	Propeller fan × 1	
Motor		W	38	34	
Air flow (at High)	(Cooling)	CMM	11.5	42	
	(Heating)		13.0	42	
Air filter, Q'ty			Polypropylene net (washable) × 2	–	
Shock & vibration absorber			–	Cushion rubber (for compressor)	
Electric heater			–	–	
Operation control Operation switch			Wireless-Remote control	–	
Room temperature control			Microcomputer thermostat	–	
Pilot lamp			RUN (Green), TIMER (Yellow), HI POWER (Green), 3D AUTO (Green)		
Safety equipment			Compressor overheat protection, Heating overload protection (High pressure control), Overcurrent protection, Frost protection, Serial signal error protection, Indoor fan motor error protection, Cooling overload protection		
Refrigerant piping	O.D	mm (in)	Liquid line: φ6.35 (1/4") Gas line: φ12.7 (1/2")		
	Connecting method		Flare connecting		
	Attached length of piping		Liquid line: 0.4 m	–	
	Insulation		Gas line : 0.33 m	Necessary (Both sides)	
Drain hose			Connectable		
Power source cord			2 m (3 cores with Earth)		
Connection wiring	Size × Core number		1.5 mm ² × 4 cores (Including earth cable)		
	Connecting method		Terminal block (Screw fixing type)		
Accessories (included)			Mounting kit, Clean filter (Allergen clear filter x1, Photocatalytic washable deodorizing filter x1)		
Optional parts			Interface kit		

Notes (1) The data are measured at the following conditions.

Operation	Item	Indoor air temperature		Outdoor air temperature		Standards
		DB	WB	DB	WB	
Cooling		27°C	19°C	35°C	24°C	ISO-T1, JIS C9612
Heating		20°C	–	7°C	6°C	ISO-T1, JIS C9612

The piping length is 7.5m.

- The operation data are applied to the 220/230/240V districts respectively.
- The refrigerant quantity to be charged includes the refrigerant in 15 m connecting piping.
(Purging is not required even for the short piping.)
If the piping length is longer, when it is 15 to 25m, add 20 g refrigerant per meter.
- If the interface kit (SC-BIK-E) (sold separately) is connected to the terminals on the indoor unit's circuit board, a wired remote control (sold separately) can be connected, a Super Link can be connected, and the unit can be turned on and off from a CNT terminal.

2.2 Range of usage & limitations

Item	Models	SRK20ZG-S, 25ZG-S, 35ZG-S	SRK50ZG-S
Indoor return air temperature (Upper, lower limits)		Cooling operation : Approximately 18 to 32°C Heating operation : Approximately 15 to 30°C	
Outdoor air temperature (Upper, lower limits)		Cooling operation : Approximately -15 to 46°C Heating operation : Approximately -15 to 21°C	
Refrigerant line (one way) length		Max. 15m	Max. 25m
Vertical height difference between outdoor unit and indoor unit		Max. 10m (Outdoor unit is higher) Max. 10m (Outdoor unit is lower)	Max. 15m (Outdoor unit is higher) Max. 15m (Outdoor unit is lower)
Power source voltage		Rating \pm 10%	
Voltage at starting		Min. 85% of rating	
Frequency of ON-OFF cycle		Max. 4 times/h (Inching prevention 10 minutes)	Max. 7 times/h (Inching prevention 5 minutes)
ON and OFF interval		Max. 3 minutes	

2.3 Exterior dimensions

(1) Indoor unit

Models SRK20ZG-S, 25ZG-S, 35ZG-S, 50ZG-S

Unit: mm

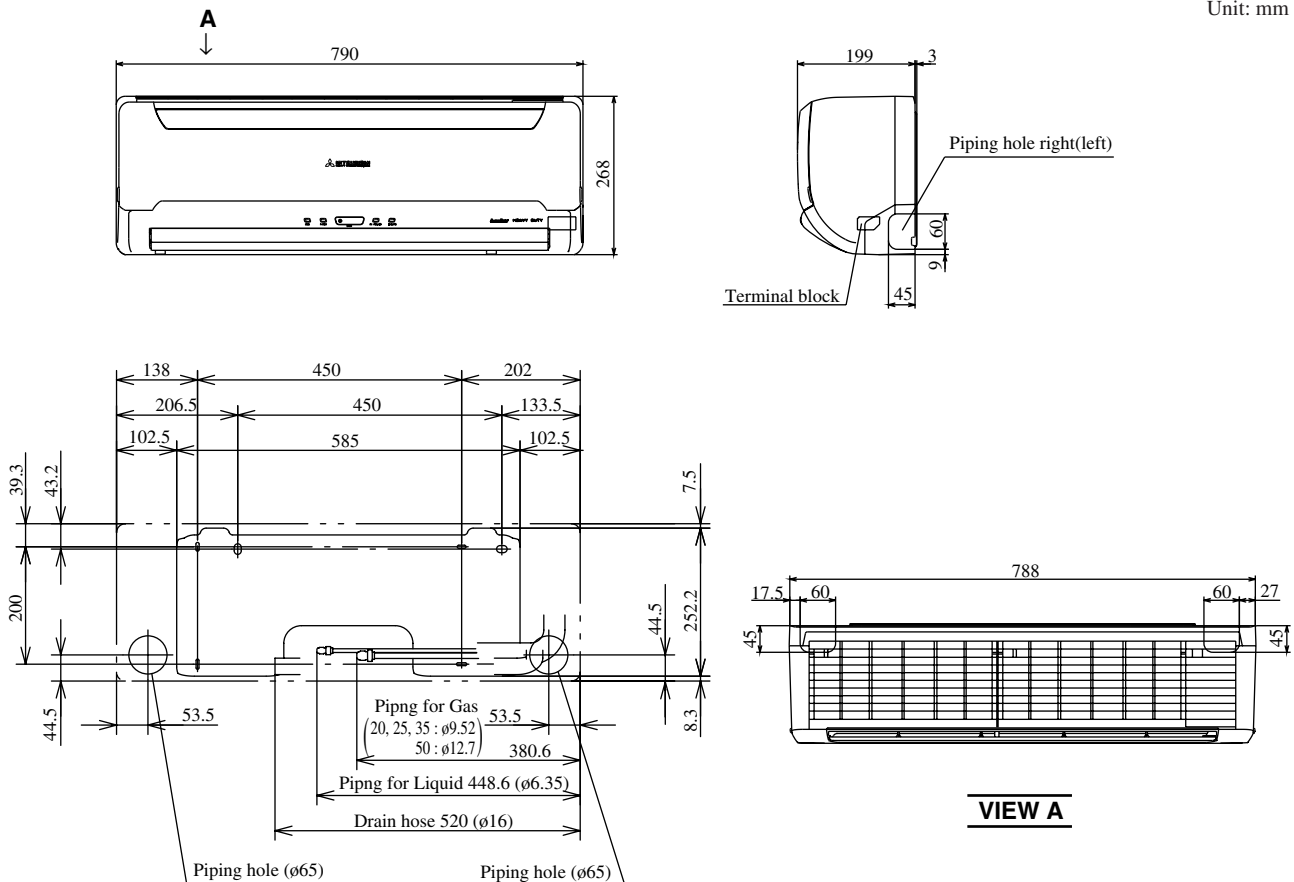

(2) Outdoor unit

Models SRC20ZG-S, 25ZG-S, 35ZG-S

Unit: mm

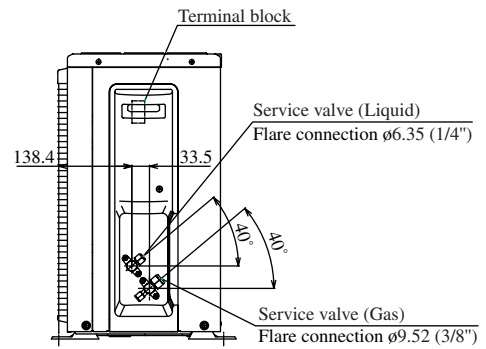
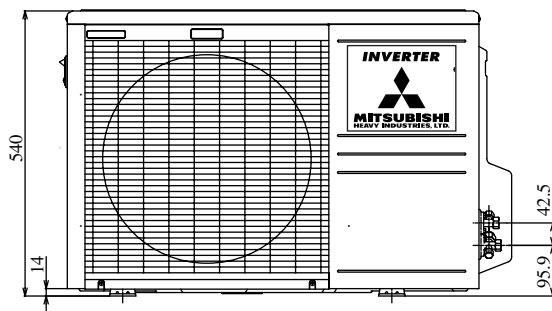
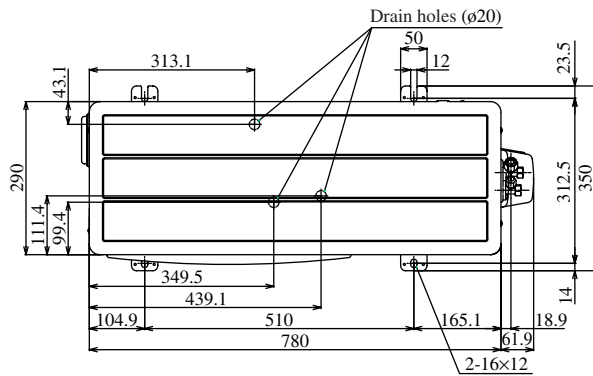

Model SRC50ZG-S

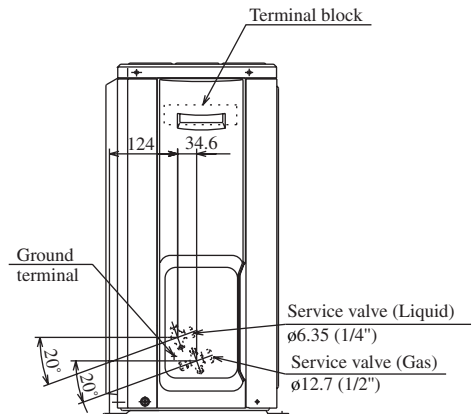
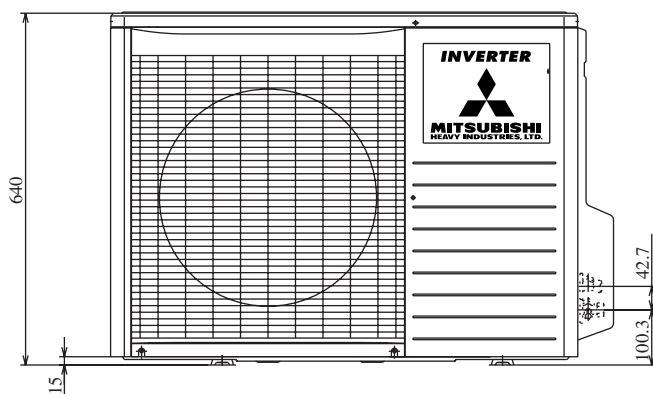
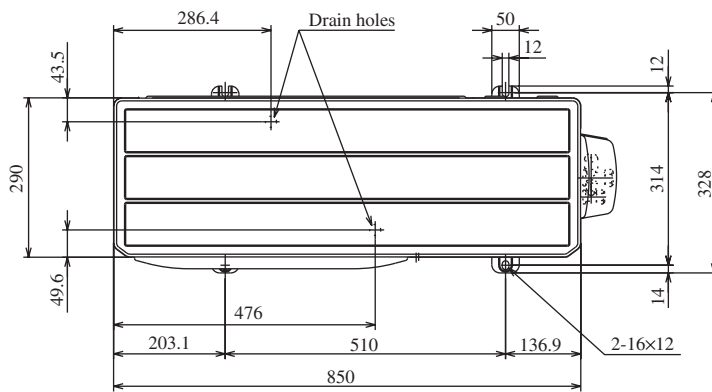

2.4 Piping system

Models SRK20ZG-S, 25ZG-S, 35ZG-S

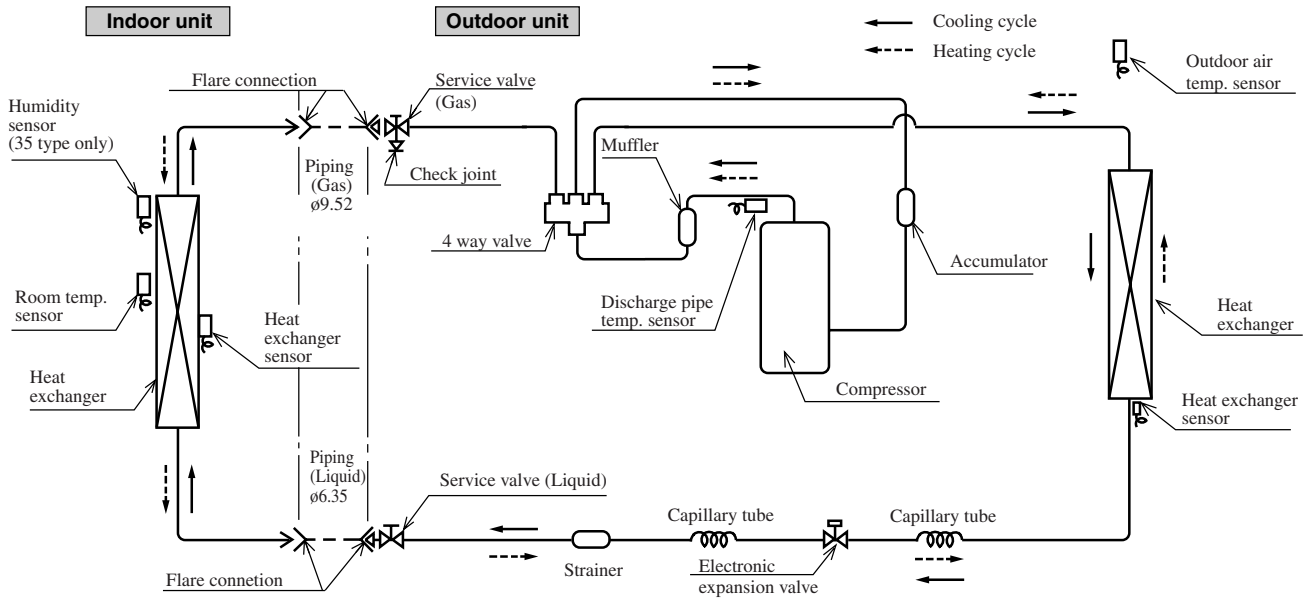

Model SRK50ZG-S

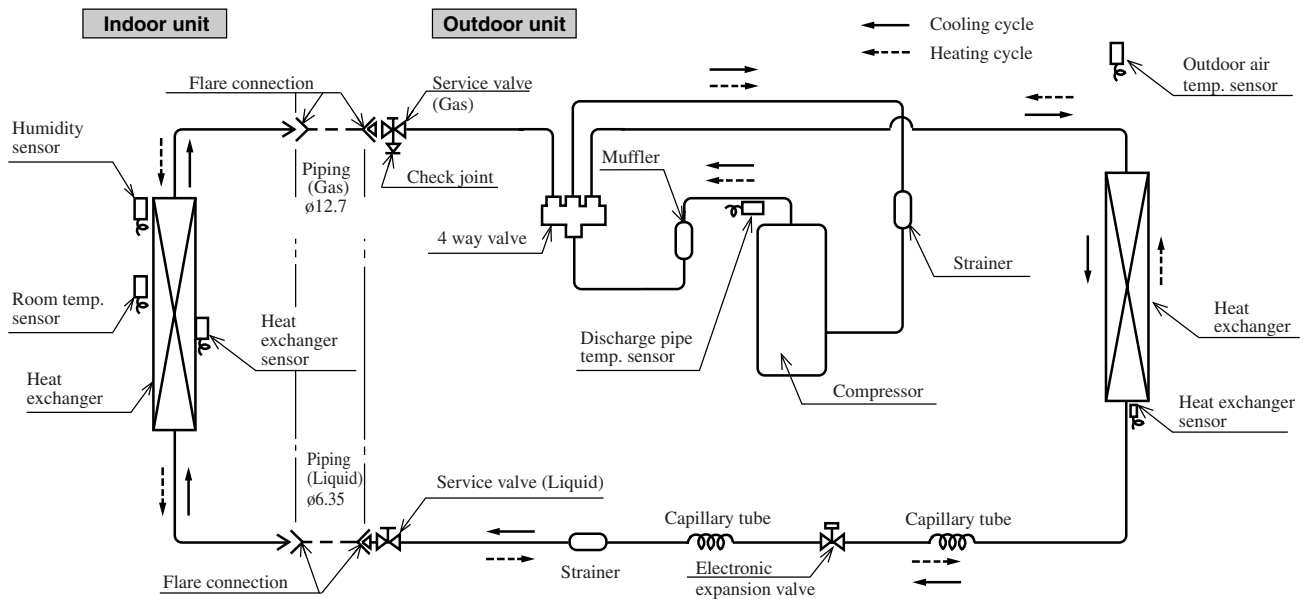

2.5 Selection chart

Correct the cooling and heating capacity in accordance with the conditions as follows. The net cooling and heating capacity can be obtained in the following way.

Net capacity = Capacity shown on specification × Correction factors as follows.

(1) Coefficient of cooling and heating capacity in relation to temperatures

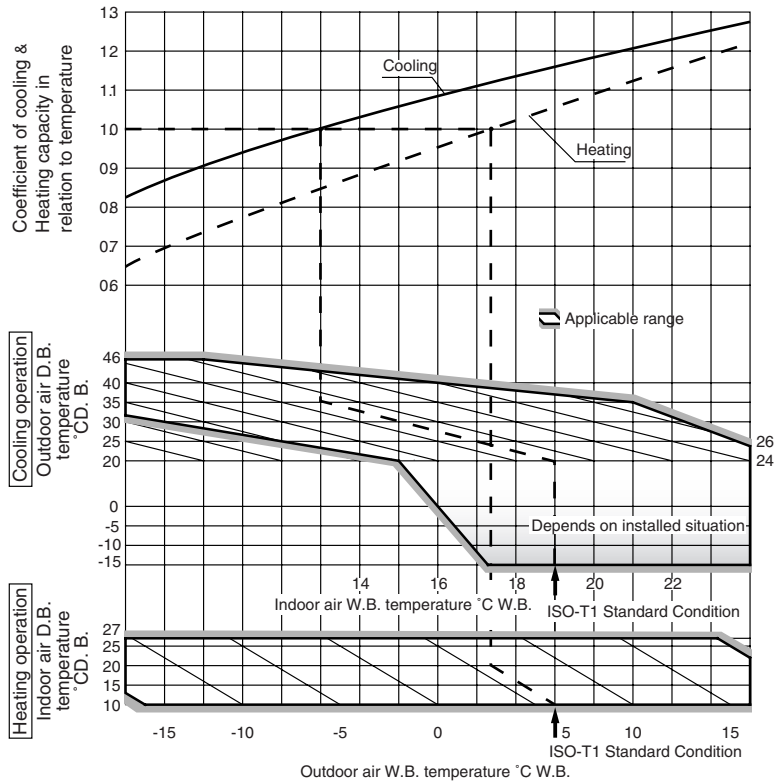

(2) Correction of cooling and heating capacity in relation to one way length of refrigerant piping

It is necessary to correct the cooling and heating capacity in relation to the one way piping length between the indoor and outdoor units.

Piping length [m]	7	10	15	20	25
Cooling	1.0	0.99	0.975	0.965	0.95
Heating	1.0	1.0	1.0	1.0	1.0

(3) Correction relative to frosting on outdoor heat exchanger during heating

In additions to the foregoing corrections (1), (2) the heating capacity needs to be adjusted also with respect to the frosting on the outdoor heat exchanger.

Air inlet temperature of outdoor unit in °CWB	-10	-9	-7	-5	-3	-1	1	3	5
Adjustment coefficient	0.95	0.94	0.93	0.91	0.88	0.86	0.87	0.92	1.00

How to obtain the cooling and heating capacity

Example : The net cooling capacity of the model SRK20ZG-S with the piping length of 15m, indoor wet-bulb temperature at 19.0°C and outdoor dry-bulb temperature 35°C is Net cooling capacity =

$$\begin{array}{ccccccc}
 \frac{2000}{\uparrow} & \times & \frac{0.975}{\uparrow} & \times & \frac{1.0}{\uparrow} & = & 1950 \text{ W} \\
 \text{SRK20ZG-S} & & \text{Length 15m} & & \text{Factor by air} & & \\
 & & & & \text{temperatures} & &
 \end{array}$$

3 ELECTRICAL DATA

3.1 Electrical wiring Models SRK20ZG-S, 25ZG-S, 35ZG-S

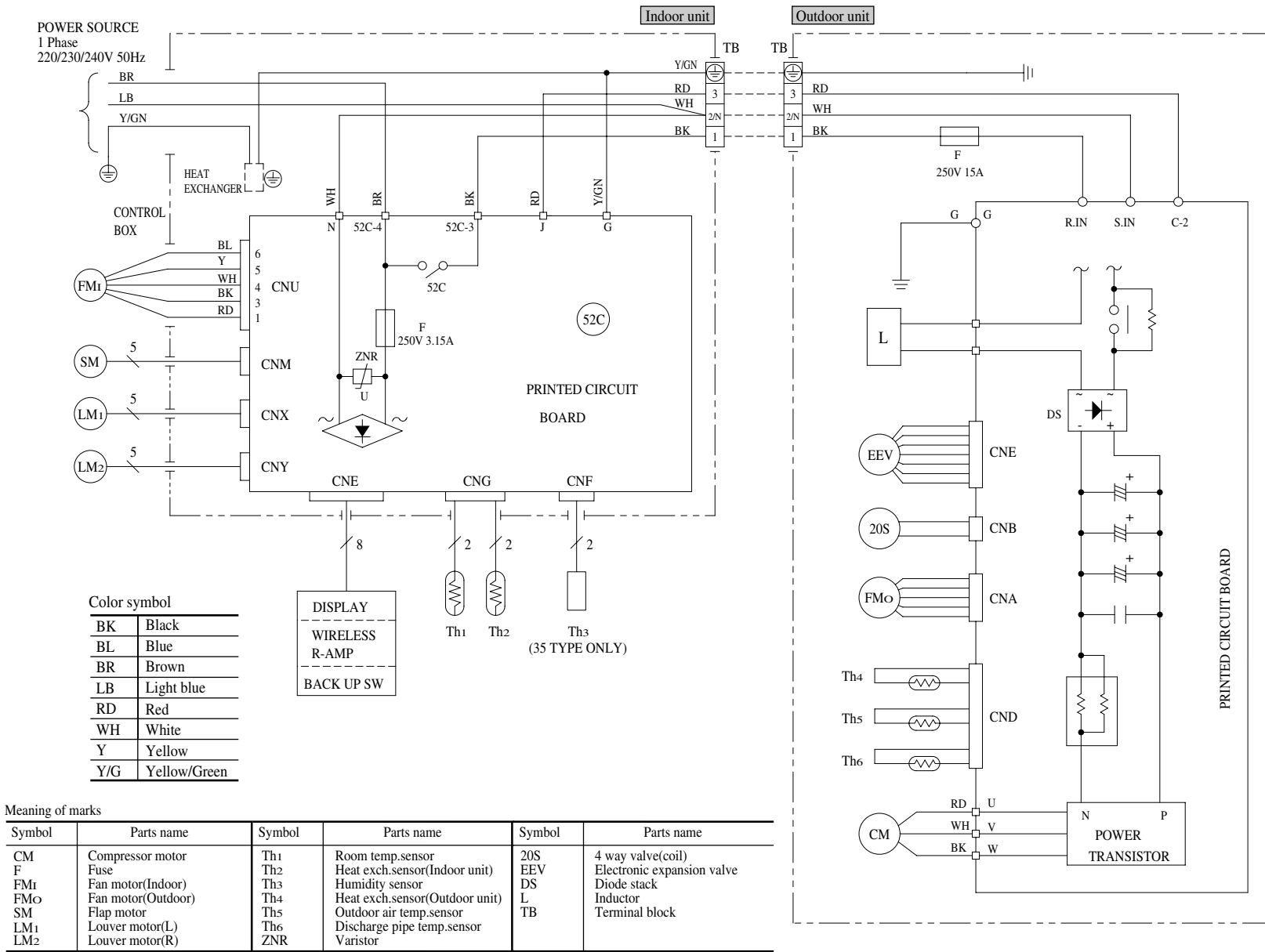

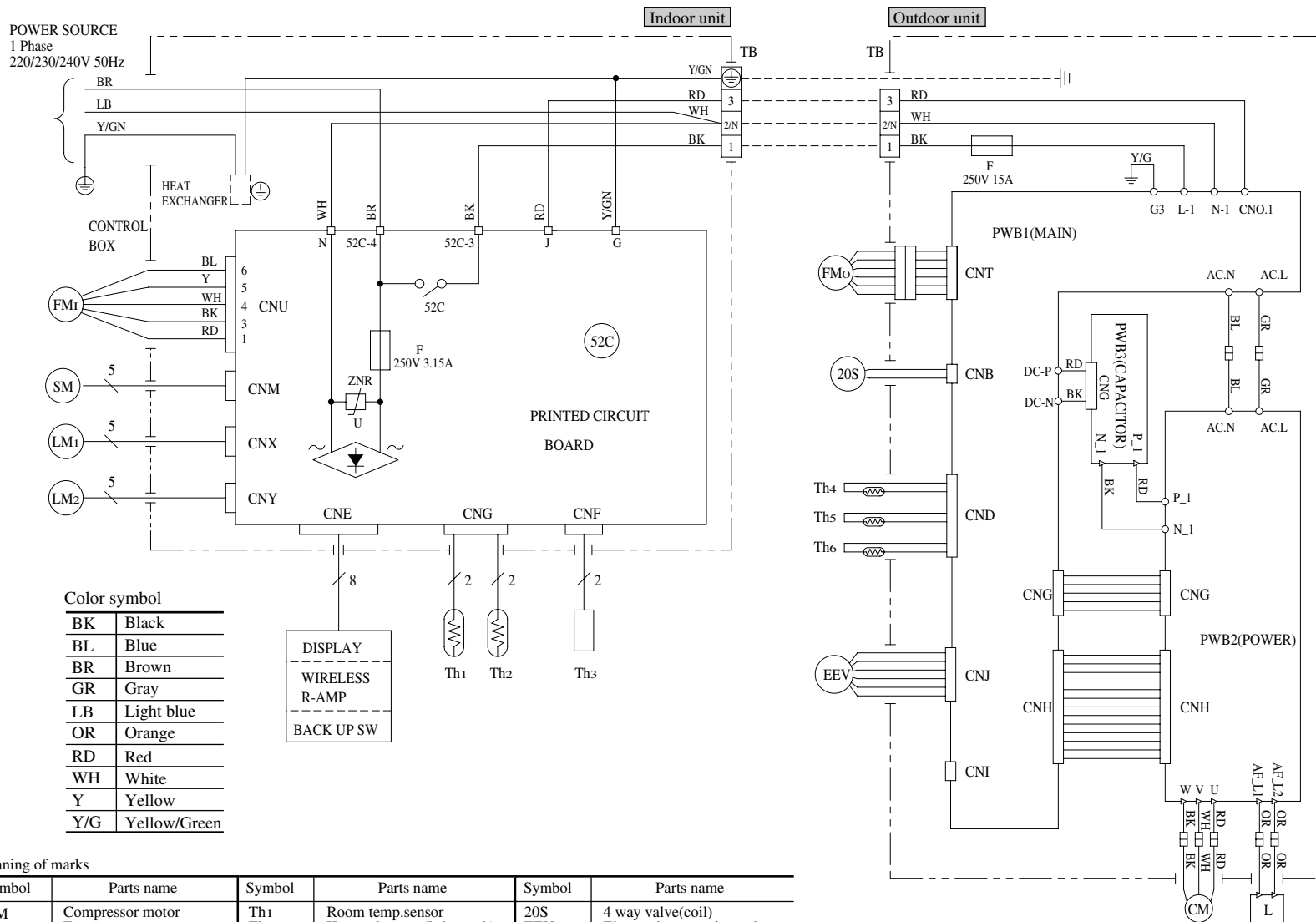

Model SRK50ZG-S

4 OUTLINE OF OPERATION CONTROL BY MICROCOMPUTER

4.1 Operation control function by remote control switch

Remote control

Models All models

◆ Operation section

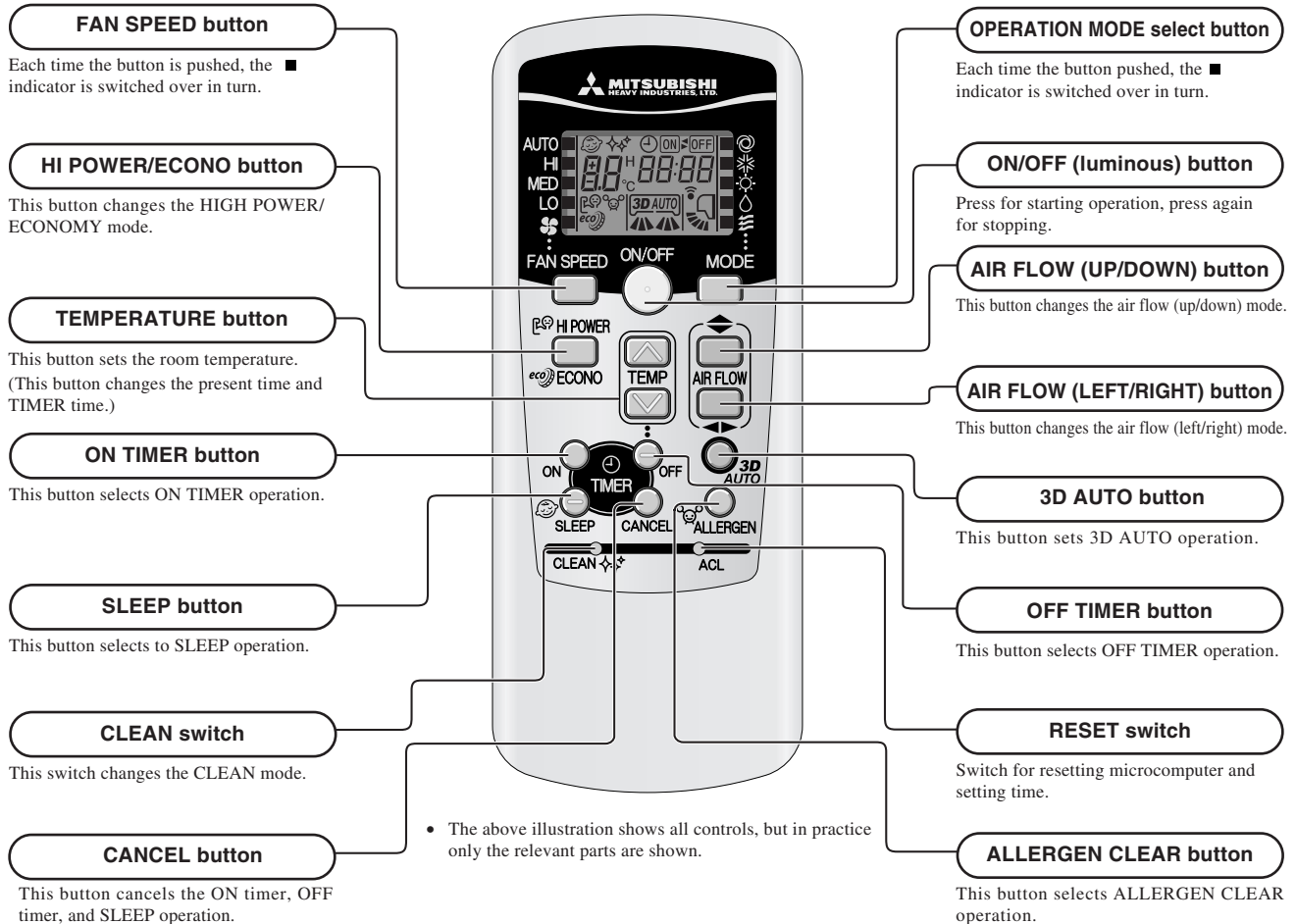

Unit indication section

Models All models

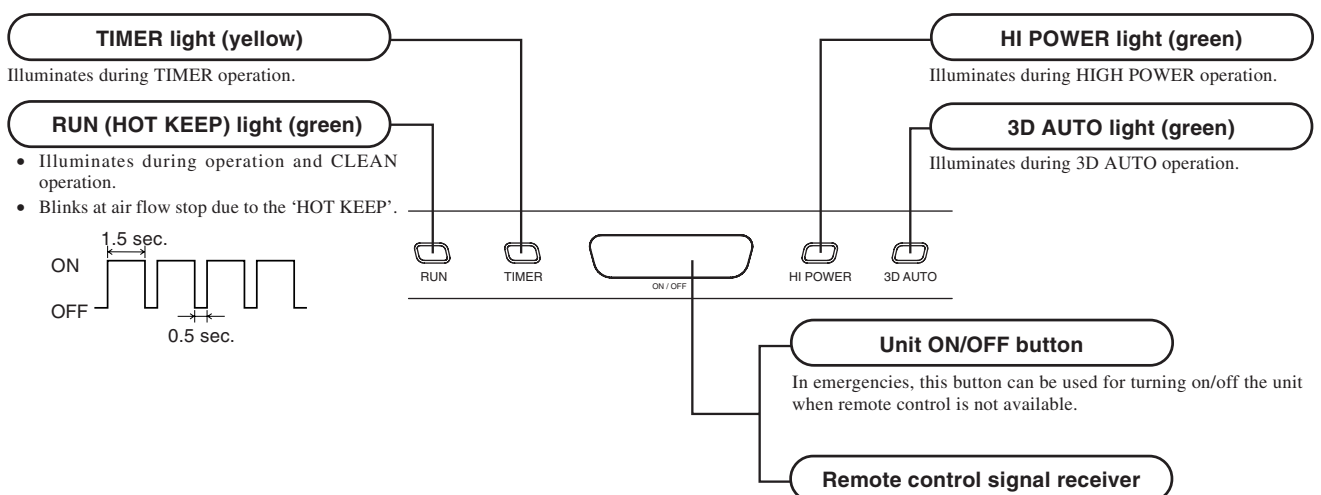

4.2 Unit ON/OFF button

When the remote control batteries become weak, or if the remote control is lost or malfunctioning, this button may be used to turn the unit on and off.

(1) Operation

Push the button once to place the unit in the automatic mode. Push it once more to turn the unit off.

(2) Details of operation

The unit will go into the automatic mode in which it automatically determines, from room temperature (as detected by sensor), whether to go into the cooling, thermal dry or heating modes.

Function	Room temperature setting	Fan speed	Flap	Timer switch
Operation mode				
Cooling	About 24°C	Auto	Auto	Continuous
Thermal dry	About 24°C			
Heating	About 26°C			

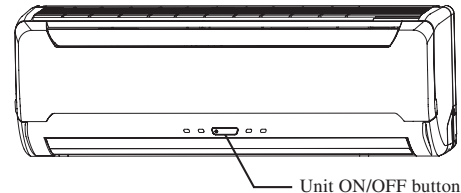

4.3 Power blackout auto restart function

(1) Power blackout auto restart function is a function that records the operational status of the air-conditioner immediately prior to it being switched off by a power cut, and then automatically resumes operations at that point after the power has been restored.

(2) The following settings will be cancelled:

- (a) Timer settings
- (b) High-power operations

- Notes
- (1) The power blackout auto restart function is set at on when the air-conditioner is shipped from the factory. Consult with your dealer if this function needs to be switched off.
 - (2) When power failure occurs, the timer setting is cancelled. Once power is resumed, reset the timer.
 - (3) If the jumper wire (J12) "AUTO RESTART" is cut, auto restart is disabled. (See the diagram at right)

Jumper wire (J12)

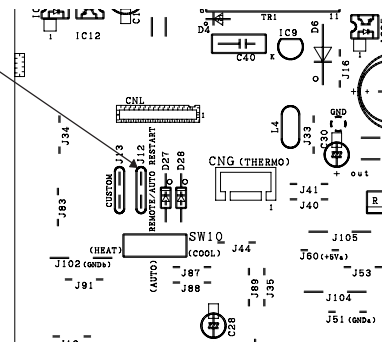

Jumper wire (J13)

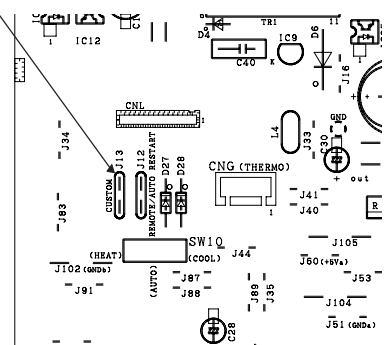

4.4 Custom cord switching procedure

If two wireless remote controls are installed in one room, in order to prevent wrong operation due to mixed signals, please modify the printed circuit board in the indoor unit's control box and the remote control using the following procedure. Be sure to modify both boards. If only one board is modified, receiving (and operation) cannot be done.

(1) Modifying the indoor unit's printed circuit board

Take out the printed circuit board from the control box and cut off jumper wire (J13) using wire cutters.

After cutting of the jumper wire, take measures to prevent contact with the other the lead wires, etc.

(2) Modifying the wireless remote control

- (a) Remove the battery.
- (b) Cut the jumper wire shown in the figure at right.

Cut



4.5 Flap and louver control

Control the flap and louver by AIRFLOW \blacklozenge (UP/DOWN) and \blacktriangleleft (LEFT/RIGHT) button on the wireless remote control.

(1) Flap

Each time when you press the AIRFLOW \blacklozenge (UP/DOWN) button the mode changes as follows.

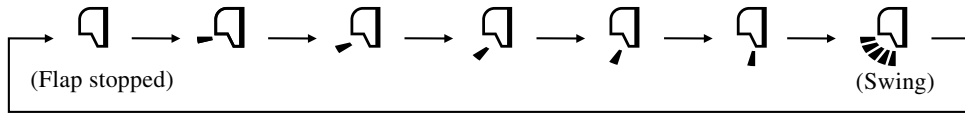

• Angle of Flap from Horizontal

Remote control display					
COOL , DRY	Approx. 10°	Approx. 20°	Approx. 30°	Approx. 45°	Approx. 60°
HEAT	Approx. 20°	Approx. 35°	Approx. 50°	Approx. 60°	Approx. 70°

(2) Louver

Each time when you press the AIRFLOW \blacktriangleleft (LEFT/RIGHT) button the mode changes as follows.

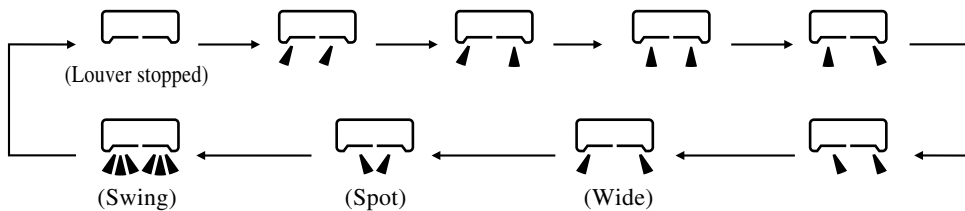

• Angle of Louver

Remote control display					
Center installation	Left Approx. 45°	Left Approx. 20°	Center	Right Approx. 20°	Right Approx. 45°
Right end installation	Left Approx. 45°	Left Approx. 30°	Left Approx. 20°	Center	Right Approx. 20°
Left end installation	Left Approx. 20°	Center	Right Approx. 20°	Right Approx. 30°	Right Approx. 45°

(3) Swing

(a) Swing flap

Flap moves in upward and downward directions continuously.

\blacklozenge In HEAT operation

\blacklozenge In COOL, DRY operation

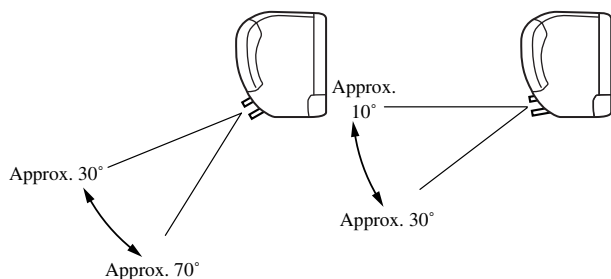

(b) Swing louver

Louver moves in left and right directions continuously.

\blacklozenge In HEAT operation

\blacklozenge In COOL, DRY operation

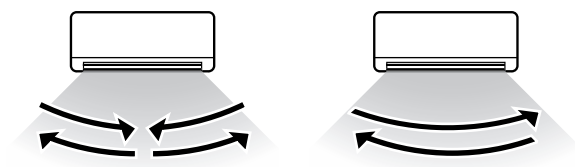

(4) Memory flap (Flap or Louver stopped)

When you press the AIRFLOW (UP/DOWN or LEFT/RIGHT) button once while the flap or louver is operating, it stops swinging at an angle. Since this angle is memorized in the microcomputer, the flap or louver will automatically be set at this angle when the next operation is started.

(5) When not operating

The flap returns to the position of air flow directly below, when operation has stopped.

4.6 3D auto operation

Control the flap and louver by 3D AUTO button on the wireless remote control.

Air flow selection and air flow direction are automatically controlled, allowing the entire room to efficiently conditioned.

(1) During Cooling and Heating (Including auto cooling and heating)

(a) Air flow selection is determined according to room temperature and setting temperature.

Operation mode	Air flow selection				
	AUTO		HI	MED	LO
At cooling	Room temp. – Setting temp. >5°C	Room temp. – Setting temp. ≤ 5°C	HI	MED	LO
	HIGH POWER	AUTO			
At heating	Setting temp. – Room temp. >5°C	Setting temp. – Room temp. ≤ 5°C	HI	MED	LO
	HIGH POWER	AUTO			

(b) Air flow direction is controlled according to the room temperature and setting temperature.

1) When 3D auto operation starts

	Cooling	Heating
Flap	Up/down Swing	
Louver	Wide (fixed)	Center (fixed)

2) When Room temp. – Setting temp. is ≤ 5°C during cooling and when Setting temp. – Room temp. is ≤ 5°C during heating, the system switches to the following air flow direction control. After the louver swings left and right symmetrically for 3 cycles, control is switched to the control in 3).

	Cooling	Heating
Flap	Horizontal blowing (Fixed)	Slant forwardl blowing (Fixed)
Louver	Left/right Swing	

3) After the flap swings for 5 cycles, control is switched to the control in 4).

	Cooling	Heating
Flap	Up/down Swing	
Louver	Center (Fixed)	

4) For 5 minutes, the following air flow direction control is carried out.

	Cooling	Heating
Flap	Horizontal blowing (Fixed)	Slant forwardl blowing (Fixed)
Louver	Wide (Fixed)	

5) After 5 minutes have passed, the air flow direction is determined according to the room temperature and setting temperature.

Operation mode	Air flow direction control		
At cooling	Room temp. – Setting temp. ≤ 2°C	2°C < Room temp. – Setting temp. ≤ 5°C	Room temp. – Setting temp. > 5°C
	The control in 4) continues.	Control returns to the control in 2).	Control returns to the control in 1).
At heating	Setting temp. – Room temp. ≤ 2°C	2°C < Setting temp. – Room temp. ≤ 5°C	Setting temp. – Room temp. > 5°C
	The control in 4) continues.	Control returns to the control in 2).	Control returns to the control in 1).

(2) During DRY Operation (including auto DRY operation)

Air flow selection	According to DRY operation.
Flap	Horizontal blowing (Fixed)
Louver	Wide (Fixed)

4.7 Timer operation

(1) Comfortable timer setting (ON timer)

If the timer is set at ON when the operation select switch is set at the cooling or heating, or the cooling or heating in auto mode operation is selected, the comfortable timer starts and determines the starting time of next operation based on the initial value of 15 minutes and the relationship between the room temperature at the setting time (temperature of room temperature sensor) and the setting temperature.

(2) Sleep timer operation

Pressing the SLEEP button causes the temperature to be controlled as shown in the following chart with respect to the set temperature.

(3) OFF timer operation

The Off timer can be set at a specific time (in 10-minute units) within a 24-hour period.

4.8 Installation location setting

When the indoor unit is installed at the end of a room, control the air flow direction so that it is not toward the side walls. If you set the remote control's installation position, keep it so that the air flow is within the range shown in the following figure.

(1) Setting

- ① **If the air conditioning unit is running, press the ON/OFF button to stop.**

The installation location setting cannot be made while the unit is running.

- ② **Press the AIR FLOW \updownarrow (UP/DOWN) button and the AIRFLOW $\leftarrow\rightarrow$ (LEFT/RIGHT) button together for 5 seconds or more.**

The installation location display illuminates.

- ③ **Setting the air-conditioning installation location.**

Press the AIR FLOW $\leftarrow\rightarrow$ (LEFT/RIGHT) button and adjust to the desired location.

Each time the AIR FLOW $\leftarrow\rightarrow$ (LEFT/RIGHT) button is pressed, the indicator is switched in the order of:



- ④ **Press the ON/OFF button.**

The air-conditioner's installation location is set.

Press within 60 seconds of setting the installation location (while the installation location setting display illuminates).

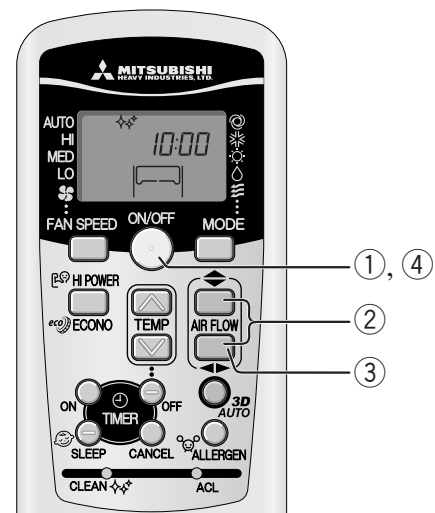
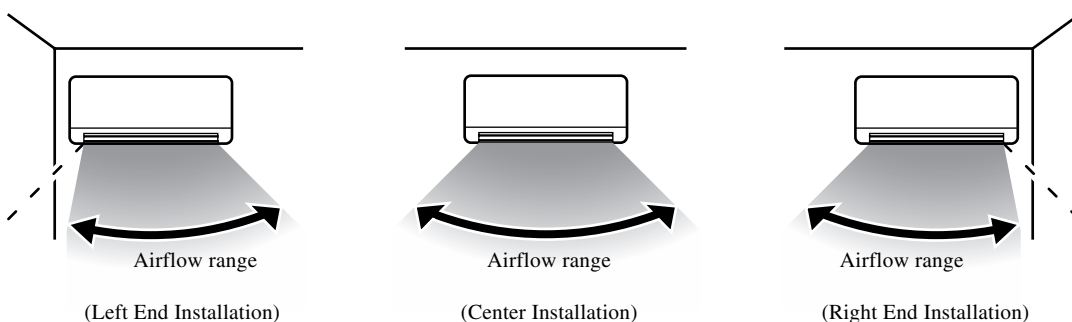

4.9 Outline of heating operation

(1) Operation of major functional components in heating mode

	Heating			
	Thermostat ON	Thermostat OFF	Defrost	Failure
Compressor	ON	OFF	OFF	OFF
Indoor fan motor	ON	ON(HOT KEEP)	OFF	OFF
Outdoor fan motor	ON	OFF (few minutes ON)	OFF	OFF
4-way valve	ON	ON	OFF	OFF (3 minutes ON)

(2) Details of control at each operation mode (pattern)

(a) Fuzzy operation

Deviation between the room temperature setting correction temperature and the suction air temperature is calculated in accordance with the fuzzy rule, and used for control of the air capacity and the inverter speed.

Model	SRK20ZG-S	SRK25ZG-S	SRK35ZG-S	SRK50ZG-S
Fan speed				
Auto	30~100rps	30~102rps		15~122rps
HI	30~100rps	30~102rps		15~122rps
MED	30~70rps	30~72rps	30~84rps	15~84rps
LO	30~44rps	30~54rps	30~62rps	15~66rps

When the defrosting, protection device, etc. is actuated, operation is performed in the corresponding mode.

(b) Hot keep operation

If the hot keep operation is selected during the heating operation, the indoor blower is controlled based on the temperature of the indoor unit heat exchanger (detected with Th2, indoor unit heat exchanger sensor) to prevent blowing of cool wind.

(3) Defrosting operation

(a) Starting conditions (Defrosting operation can be started only when all of the following conditions are met.)

- ① After start of heating operation
When it elapsed 45 minutes (35, 50 type : 35 minutes). (Accumulated compressor operation time)
- ② After end of defrosting operation
When it elapsed 45 minutes(35, 50 type : 35 minutes). (Accumulated compressor operation time)
- ③ Outdoor unit heat exchanger sensor (Th4) temperature
When the temperature has been below -5°C for 3 minutes continuously.
- ④ The difference between the outdoor air sensor temperature and the outdoor unit heat exchanger sensor temperature
 - The outdoor air temperature $\geq -17^{\circ}\text{C}$: 7°C (35type : 5°C , 50type : 4°C) or higher
 - The outdoor air temperature $< -17^{\circ}\text{C}$: -5°C or higher
- ⑤ During continuous compressor operation
In addition, when the speed command from the indoor controller of the indoor unit during heating operation has counted 0 rps 10 times or more and all conditions of ①, ②, ③ and ⑤ above and the outdoor air temperature is 3°C or less are satisfied (note that when the temperature for Th4 is -5°C or less: 62 rps or more, -4°C or less: less than 62 rps), defrost operation is started.

(b) Ending conditions (Operation returns to the heating cycle when either one of the following is met.)

- ① Outdoor heat exchanger sensor (Th4) temperature: 13°C or higher
- ② Continued operation time of defrosting → For more than 10 min.

4.10 Outline of cooling operation

(1) Operation of major functional components in Cooling mode

	Cooling		
	Thermostat ON	Thermostat OFF	Failure
Compressor	ON	OFF	OFF
Indoor fan motor	ON	ON	ON
Outdoor fan motor	ON	OFF (few minutes ON)	OFF (few minutes ON)
4-way valve	OFF	OFF	OFF

(2) Detail of control in each mode (Pattern)

(a) Fuzzy operation

During the fuzzy operation, the air flow and the inverter speed are controlled by calculating the difference between the room temperature setting correction temperature and the suction air temperature.

Model	SRK20ZG-S	SRK25ZG-S	SRK35ZG-S	SRK50ZG-S
Fan speed				
Auto	20~64rps	20~68rps	20~98rps	15~100rps
HI	20~64rps	20~68rps	20~98rps	15~100rps
MED	20~48rps	20~52rps	20~74rps	15~62rps
LO	20~32rps	20~38rps	20~46rps	15~30rps

4.11 Outline of automatic operation

(1) Determination of operation mode

The unit checks the room temperature and the outdoor air temperature, determines the operation mode, and then begins in the automatic operation.

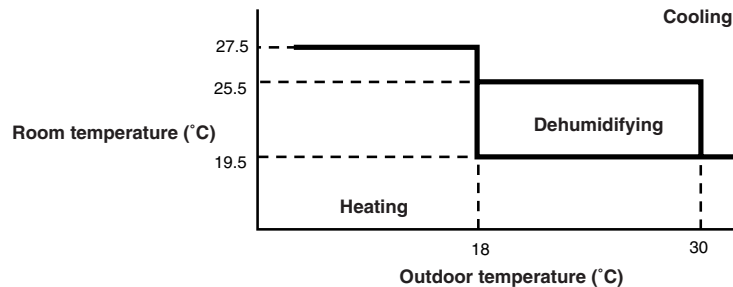

- The unit checks the temperature every hour after the start of operation and, if the result of check is not same as the previous operation mode, changes the operation mode.
- When the unit is started again within one hour after the stop of automatic operation or when the automatic operation is selected during heating, cooling or dehumidifying operation, the unit is operated in the previous operation mode.
- Setting temperature can be adjusted within the following range. There is the relationship as shown below between the signals of the wireless remote control and the setting temperature.

Setting temperature		Signals of wireless remote control (Display)												
		-6	-5	-4	-3	-2	-1	±0	+1	+2	+3	+4	+5	+6
Setting temperature	Cooling	18	19	20	21	22	23	24	25	26	27	28	29	30
	Dehumidifying	18	19	20	21	22	23	24	25	26	27	28	29	30
	Heating	20	21	22	23	24	25	26	27	28	29	30	31	32

4.12 Protective control function

(1) Frost prevention for indoor heat exchanger (During cooling or dehumidifying)

(a) Operating conditions

- 1) Indoor heat exchanger temperature (detected with Th2) is lower than 5°C.
- 2) 10 minutes after reaching the inverter command speed except 0 rps.

(b) Detail of anti-frost operation

Item	Indoor heat exchanger temperature	
	5°C or lower	2.5°C or lower
Upper limit speed	20, 25 type : 44 rps 35 type : 70 rps 50 type : 76 rps	0rps
Indoor fan	Depends on operation mode	Protects the fan tap just before frost prevention control
Outdoor fan	Depends on operation mode	Depends on stop mode
4-way valve	OFF	

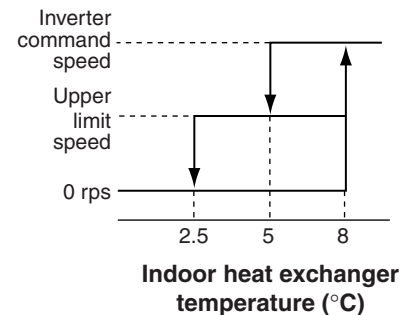

- (c) **Reset conditions:** The indoor heat exchanger temperature (Th2) is 8°C or higher after 5 minutes of operation following control of the inverter command speed upper limit.

(2) Cooling overload protective control

- (a) **Operating conditions:** When the outdoor unit is operating with the outdoor unit speed of other than 0 rps, and when the outdoor air temperature sensor (Th5) becomes 41°C or over for 30 seconds continuously.

(b) Detail of operation

- 1) Outdoor fan is stepped up by 3 speed step. (Upper limit speed is 7th speed.)
- 2) The lower limit of control speed is set to 30 rps and even if the calculated result becomes lower than that after fuzzy calculation, the speed is kept to 30 rps. However, when the thermo becomes OFF, the speed is reduced to 0 rps.

- (c) **Reset conditions:** When either of the following condition is satisfied.

- ① When the outdoor air temperature becomes 40°C or less.
- ② When the inverter command speed is 0rps.

(3) Cooling low outdoor temperature protective control

◆ < I >

- (a) **Operating conditions:** When the outdoor air temperature sensor (Th5) is 22°C or lower continues for 30 seconds while outdoor speed is other than 0rps.

- (b) **Detail of operation:** After the outdoor fan operates at A speed for 60 seconds; the corresponding outdoor heat exchanger temperature shall implement the following controls.

● Value of A

	Outdoor fan
Outdoor temperature > 10°C	2nd speed
Outdoor temperature ≤ 10°C	1st speed

- ① Outdoor heat exchanger temperature ≤ 21°C
After the outdoor fan speed drops (down) to one speed for 60 seconds; if the outdoor heat exchanger temperature is lower than 21°C, gradually reduce the outdoor fan speed by 1 speed. (Lower limit speed is 1st speed)
- ② 21°C < Outdoor heat exchanger temperature ≤ 38°C
After the outdoor fan speed maintains at A speed for 20 seconds; if the outdoor heat exchanger temperature is 21°C~38°C, maintain outdoor fan speed.
- ③ Outdoor heat exchanger temperature > 38°C
After the outdoor fan speed rises (up) to 1 speed for 60 seconds; if the outdoor heat exchanger temperature is higher than 38°C, gradually increase outdoor fan speed by 1 speed. (Upper limit speed is 3rd speed)

- (c) **Reset conditions:** When the either of the following conditions is satisfied

- ① When the outdoor air temperature sensor (Th5) becomes 25°C or higher.
- ② When the inverter command speed is 0rps.

◆ < II >

(a) **Operating conditions:** When the outdoor air temperature sensor (Th5) is 22°C or lower continues for 30 seconds while outdoor speed is other than 0rps.

(b) **Detail of operation:**

- ① The lower limit of inverter command speed is set to C(D)rps and even if the speed becomes lower than C(D)rps, the speed is kept to C(D)rps. However, when the thermo becomes OFF, the speed is reduced to 0rps.
- ② The upper limit of control speed is set to A(B)rps and even if the calculated result becomes higher than that after fuzzy calculation, the speed is kept to A(B)rps.

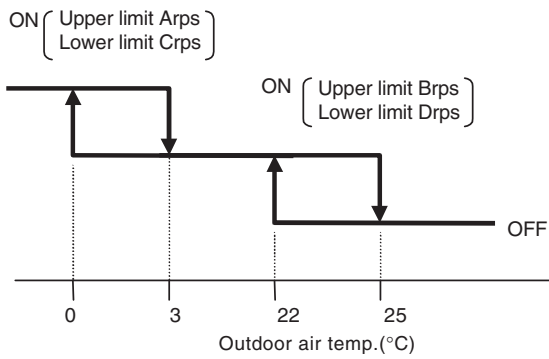

● Values of A, B, C, D

	Upper limit		Lower limit	
	A	B	C	D
20, 25, 35 type	40	60	30	30
50 type	50	60	44	30

(c) **Reset conditions:** When the either of the following condition is satisfied

- ① When the outdoor air temperature sensor (Th5) becomes 25°C or higher.
- ② When the inverter command speed is 0rps.

(4) **High pressure control**

(a) **Purpose:** Prevents anomalous high pressure operation during heating.

(b) **Detector:** Indoor unit heat exchanger sensor (Th2)

(c) **Detail of operation:**

(Example) Fuzzy

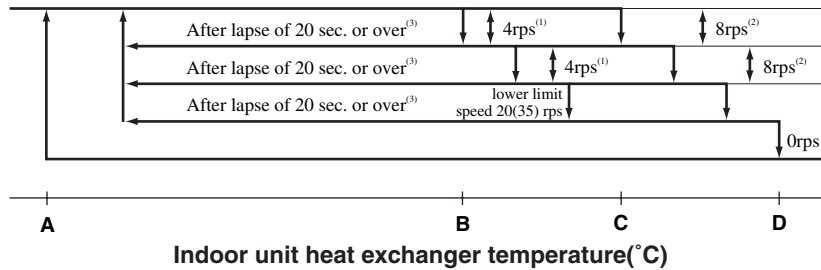

- Notes
- (1) When the indoor unit heat exchanger temperature is in the range of B~C °C, the speed is reduced by 4 rps at each 20 seconds.
 - (2) When the indoor unit heat exchanger temperature is in the range of C~D °C, the speed is reduced by 8 rps at each 20 seconds. When the temperature is D °C or over for 1 minute continuously, the inverter is stopped.
 - (3) When the indoor unit heat exchanger temperature is in the range of A~B °C, if the inverter command speed is been maintained and the operation has continued for more than 20 seconds at the same speed, it returns to the normal heating operation.
 - (4) Indoor blower retains the fan tap when it enters in the high pressure control. Outdoor blower is operated in accordance with the speed.

● **Temperature list**

Unit : °C

	A	B	C	D
RPSmin < 40(88)	48 (48.5)	53 (55)	55 (58)	58 (61)
40(88) ≤ RPSmin < 50(108)	48 (44)	53 (50.5)	55 (53)	58 (56.5)
50(108) ≤ RPSmin	48.5 (39)	56 (45.5)	58 (48)	61 (51.5)

Notes (1) RPSmin: The lower one between the outdoor unit speed and the command speed

(2) Values in () are for Type 50.

(5) Heating overload protective control

(a) Operating conditions: When the unit is operating with the outdoor unit speed other than 0 rps or when the outdoor air temperature sensor (Th5) rose beyond 22°C for 30 seconds continuously.

(b) Detail of operation:

- ① Taking the upper limit of control speed range at 60 rps, if the output speed obtained with the fuzzy calculation exceeds the upper limit, the upper limit value is maintained.
- ② The lower limit of control speed is set to 40(35) rps and even if the calculated result becomes lower than that after fuzzy calculation, the speed is kept to 40(35) rps. However, when the thermo becomes OFF, the speed is reduced to 0 rps.
- ③ Inching prevention control is activated and inching prevention control is carried out with the minimum speed set at 40 (35) rps.
- ④ The outdoor fan is set on 2nd speed.

(c) Reset conditions: When the outdoor air temperature drops below 21°C.

Note (1) Values in () are for Type 50.

(6) Heating low outdoor temperature protective control

◆ <I>

(a) Operating conditions: When the outdoor air temperature sensor (Th5) is 4°C or lower continues for 5 minutes while the outdoor speed is other than 0 rps.

(b) Detail of operation:

- ① When the command speed is less than 40(22) rps, the command speed is forcibly set at 40(22) rps. However, when the thermo becomes OFF, the speed is reduced 0 rps.
- ② Inching prevention control is activated and inching prevention control is carried out with the minimum speed set at 40 (22) rps.

(c) Reset conditions: When the either of the following condition is satisfied.

- ① When the outdoor air temperature sensor (Th5) becomes 6°C or higher.
- ② When the inverter command speed is 0 rps.

◆ <II>

(a) Operating conditions: When the outdoor air temperature sensor (Th5) is 0°C or lower continuously for 30 seconds while the outdoor speed is other than 0 rps.

(b) Detail of operation: The outdoor fan motor speed is stepped up by 1(2) speed step. (Upper limit 7th speed)

(c) Reset conditions: When the either of the following condition is satisfied.

- ① When the outdoor air temperature sensor (Th5) becomes 2°C or higher.
- ② When the inverter command speed is 0 rps.

◆ <III> (SRK50ZG-S only)

(a) Operating conditions: When the outdoor heat exchanger sensor (Th4) is -10°C or lower continuously for 10 minutes while the outdoor speed is other than 0 rps.

(b) Detail of operation: When the command speed upper limit is set at 50 rps.

(c) Reset conditions: When the either of the following condition is satisfied.

- ① When the outdoor heat exchanger sensor (Th4) becomes -7°C or higher.
- ② When the inverter command speed is 0 rps.
- ③ After 2 minutes have passed since this control started.

(7) Compressor overheat protection

(a) Purpose: It is designed to prevent deterioration of oil, burnout of motor coil and other trouble resulting from the compressor overheat.

(b) Detail of operation

1) Speeds are controlled with temperature detected by the sensor mounted on the discharge pipe.

(Example) Fuzzy

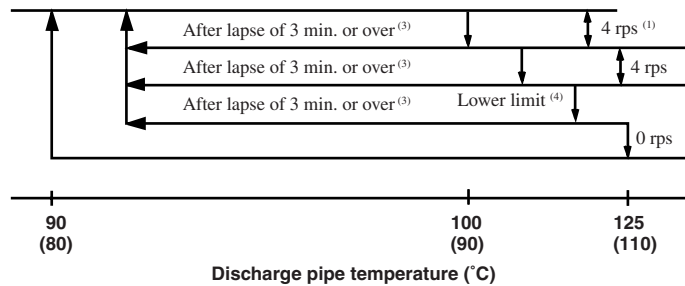

- Notes (1) When the discharge pipe temperature is in the range of 100(90) to 125(110)°C, the speed is reduced by 4 rps.
 (2) When the discharge pipe temperature is raised and continues operation for 20 seconds without changing, then the speed is reduced again by 4 rps.
 (3) If the discharge pipe temperature is still 90 (80) °C or greater but less than 100 (90) °C even when the inverter command speed is maintained for 3 minutes when the temperature is 90 (80) °C or greater but less than 100 (90) °C, the speed is raised by 2 rps and kept at that speed for 3 minutes. This process is repeated until the command speed is reached.

(4) Lower Limit Speed

	Cooling	Heating
20, 25, 35 type	20 rps	30 rps
50 type	22 rps	38 rps

(5) Values in () are for Type 50.

2) If the temperature of 125 (110)°C is detected by the sensor on the discharge pipe, then the compressor will stop immediately. When the discharge pipe temperature drops and the time delay of 3 minutes is over, the unit starts again within 1 hour but there is no start at the third time.

(8) Current safe

(a) Purpose: Current is controlled not to exceed the upper limit of the setting operation current.

(b) Detail of operation: Input current to the converter is monitored with the current sensor fixed on the printed circuit board of the outdoor unit and, if the operation current value reaches the limiting current value, the outdoor unit speed is reduced.

If the mechanism is actuated when the speed of outdoor unit is less than 30 rps, the compressor is stopped immediately. Operation starts again after a delay time of 3 minutes.

(9) Current cut

(a) Purpose: Inverter is protected from overcurrent.

(b) Detail of operation: Output current from the converter is monitored with a shunt resistor and, if the current exceeds the setting value, the compressor is stopped immediately. Operation starts again after a delay time of 3 minutes.

(10) Outdoor unit failure

This is a function for determining when there is trouble with the outdoor unit during air conditioning.

The compressor is stopped if any one of the following in item 1), 2) is satisfied. Once the unit is stopped by this function, it is not restarted.

- 1) When the input current is measured at 1 A or less for 3 continuous minutes or more.
- 2) If the outdoor unit sends a 0 rps signal to the indoor unit 3 times or more within 20 minutes of the power being turned on.

(11) Inching prevention

When the compressor goes into the thermo operation within 10(5) minutes since operation start or becomes various dehumidifying operations, the operation is continued with the lower limit speed forcibly.

Note (1) Values in () are for Type 50.

(12) Indoor fan motor protection

When the air conditioner is operating and the indoor fan motor is turned ON, if the indoor fan motor has operated at 300 rpm or under for more than 30 seconds, the unit enters first in the stop mode and then stops the entire system.

(13) Serial signal transmission error protection

(a) Purpose: Prevents malfunction resulting from error on the indoor ↔ outdoor signals.

(b) Detail of operation: If the compressor is operating and a serial signal cannot be received from the indoor control with outdoor control having serial signals continuously for 1 minute and 55 seconds, the compressor is stopped.

After the compressor has been stopped, it will be restarted after the compressor start delay if a serial signal can be received again from the indoor control.

(14) Rotor lock





If the motor for the compressor does not turn 1/12 revolution 0.044 seconds after it has been started, it is determined that a compressor lock has occurred and the compressor is stopped.

(15) Outdoor fan motor protection

If the outdoor fan motor has operated at 75rpm or under for more than 30 seconds, the inverter and fan motor are stopped.

5 APPLICATION DATA



SAFETY PRECAUTIONS

- Please read these “Safety Precautions” first then accurately execute the installation work.
- Though the precautionary points indicated herein are divided under two headings,  and  , those points which are related to the strong possibility of an installation done in error resulting in death or serious injury are listed in the  section. However, there is also a possibility of serious consequences in relationship to the points listed in the  section as well. In either case, important safety related information is indicated, so by all means, properly observe all that is mentioned.
- After completing the installation, along with confirming that no abnormalities were seen from the operation tests, please explain operating methods as well as maintenance methods to the user (customer) of this equipment, based on the owner’s manual. Moreover, ask the customer to keep this sheet together with the owner’s manual.

WARNING

- To disconnect the appliance from the mains supply this appliance must be connected to the mains by means of a circuit breaker or a switch (use a recognized 16A) with a contact separation of at least 3mm.
- The appliance shall be installed in accordance with national wiring regulations.
- When a plug is connected to the power cord, a plug conforming to the IEC60884-1 standard must be used.
- This system should be applied to places as households, residences and the like. Application to inferior environment such as engineering shop could cause equipment malfunction.
- Please entrust installation to either the company which sold you the equipment or to a professional contractor. Defects from improper installations can be the cause of water leakage, electric shocks and fires.
- Execute the installation accurately, based on following the installation manual. Again, improper installations can result in water leakage, electric shocks and fires.
- For installation, confirm that the installation site can sufficiently support heavy weight. When strength is insufficient, injury can result from a falling of the unit.
- For electrical work, please see that a licensed electrician executes the work while following the safety standards related to electrical equipment, and local regulations as well as the installation instructions, and that only exclusive use circuits are used.
Insufficient power source circuit capacity and defective installment execution can be the cause of electric shocks and fires.
- Accurately connect wiring using the proper cable, and insure that the external force of the cable is not conducted to the terminal connection part, through properly securing it. Improper connection or securing can result in heat generation or fire.
- Take care that wiring does not rise upward, and accurately install the lid/service panel. It’s improper installation can also result in heat generation or fire.
- When setting up or moving the location of the air conditioner, do not mix air etc. or anything other than the designated refrigerant (R410A) within the refrigeration cycle.
Rupture and injury caused by abnormal high pressure can result from such mixing.
- Always use accessory parts and authorized parts for installation construction. Using parts not authorized by this company can result in water leakage, electric shock, fire and refrigerant leakage.
- Ventilate the work area when refrigerant leaks during the operation. 
Coming in contact with fire, refrigerant could generate toxic gas.
- Confirm after the foundation construction work that refrigerant does not leak.
If coming in contact with fire of a fan heater, a stove or movable cooking stove, etc., refrigerant leaking in the room could generate toxic gas.
- In joining pipes, do not use conventional (R22) piping flare nuts, etc. The use of conventional piping materials may lead to the rupture of piping due to higher pressure used for the refrigerant cycle and possible personal injury.
(Use only piping material designed specifically for R410A)

CAUTION

- Execute proper grounding. Do not connect the ground wire to a gas pipe, water pipe, lightning rod or a telephone ground wire. 
Improper placement of ground wires can result in electric shock.
- The installation of an earth leakage breaker is necessary depending on the established location of the unit.
Not installing an earth leakage breaker may result in electric shock.
- Do not install the unit where there is a concern about leakage of combustible gas. 
The rare event of leaked gas collecting around the unit could result in an outbreak of fire.
- For the drain pipe, follow the installation manual to insure that it allows proper drainage and thermally insulate it to prevent condensation. Inadequate plumbing can result in water leakage and water damage to interior items.
- Do not place objects near the outdoor unit or allow leaves to gather around the unit. If there are objects or leaves around the outdoor unit, small animals may enter unit and contact electrical parts resulting in break down, emission of smoke or flame.

5.1 Selection of location for installation

(1) Indoor unit

- Where there is no obstructions to the air flow and where the cooled air can be evenly distributed.
- A solid place where the unit or the wall will not vibrate.
- A place where there will be enough space for servicing. (Where space mentioned right can be secured)
- Where wiring and the piping work will be easy to conduct.
- The place where receiving part is not exposed to the direct rays of the sun or the strong rays of the street lighting.
- A place where it can be easily drained.
- A place separated at least 1m away from the television or the radio. (To prevent interference to images and sound.)

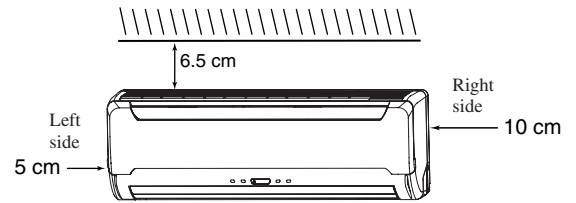

(2) Outdoor unit

- A place where good air circulation can be obtained and where rain, snow or sunshine will not directly strike the unit.
- A place where discharged hot air or unit's operating sound will not be a nuisance to the neighborhood.
- A place where servicing space can be secured.
- A place where vibration will not be enlarged.
- Avoid installing in the following places.
 - A place near the bed room and the like, so that the operation noise will cause no trouble.
 - A place where there is possibility of flammable gas leakage.
 - A place exposed to strong wind.
 - In a salt-laden atmosphere or a place where the generation of oil mist, vapor or fume is expected.

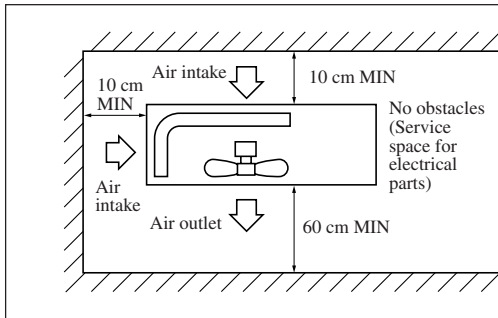

- Notes (1) Blowing out port and suction port on the back side of the unit can be installed at a distance of 10cm from walls.
 (In case the barrier is 1.2m or above in height, or is overhead, the sufficient space between the unit and wall shall be secured.)
 (2) When the unit is installed, the space of the following dimension and above shall be secured.

- In heating operation, snow deposit on the heat-exchanger of outdoor unit must be prevented for keeping the normal performance capacity.
 - Snow-hood on outdoor unit as in drawing, will reduce the frequency of defrost operation.
When installing the snow hood, take care so that the air outlet of the snow hood will not face directly into the most windy direction.
 - Design the base higher than possible snow deposit.

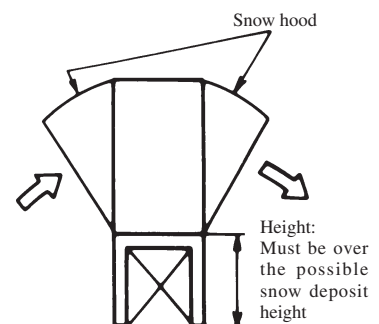

(3) Limitations for one way piping length and vertical height difference.

Item		Model	
		20, 25, 35 type	50 type
One way piping length (ℓ)		15 m	25 m
Vertical height difference (h)	Outdoor unit is lower	10 m	15 m
	Outdoor unit is higher	10 m	15 m

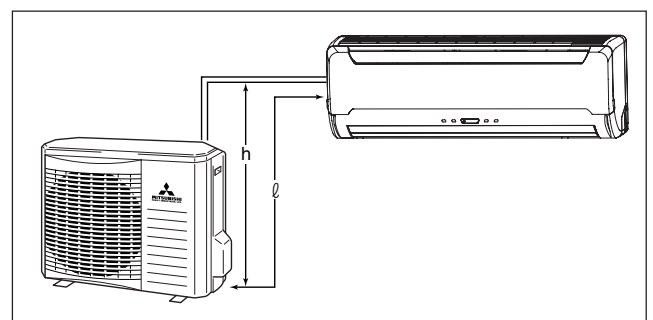

5.2 Installation of indoor unit

(1) Installation of installation board

(a) Fixing of installation board

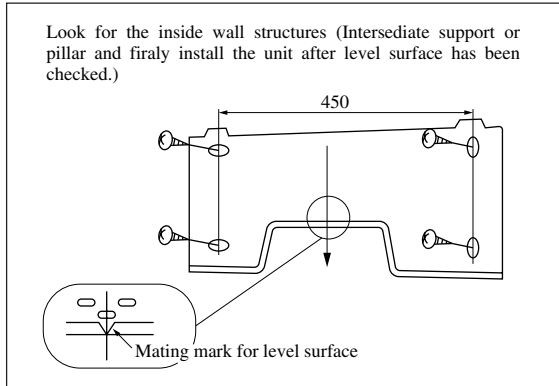

Adjustment of the installation board in the horizontal direction is to be conducted with four screws in a temporary tightened state.

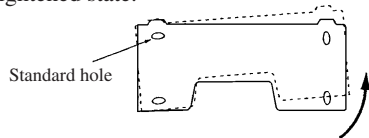

Adjust so that board will be level by turning the board with the standard hole as the center.

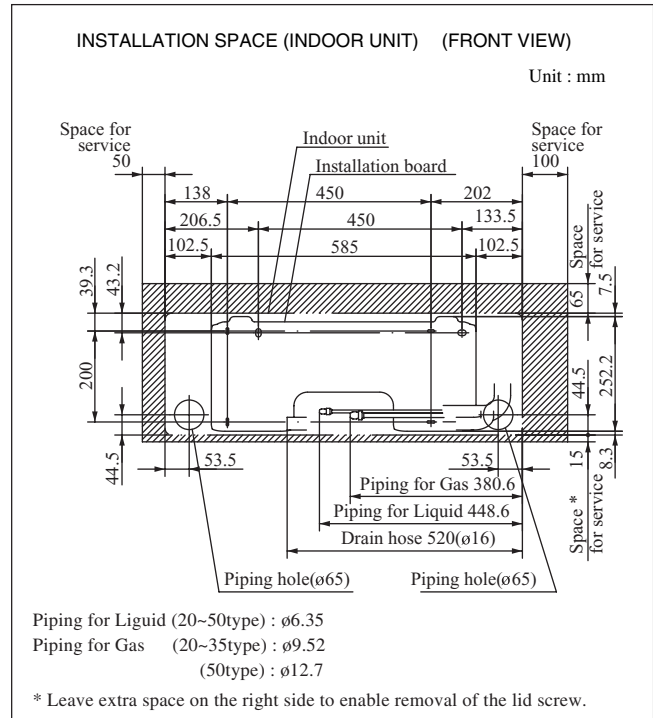
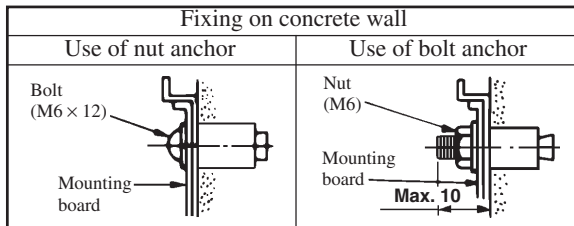

(2) Drilling of holes and fixture sleeve (Option Parts)

When drilling the wall that contains a metal lath, wire lath or metal plate, be sure to use pipe hole sleeve sold separately.

(a) Drill a hole with ø65 whole core drill

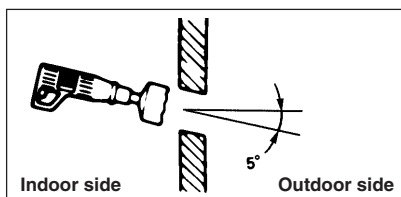

Note (1) Drill a hole with incline of 5 degree from indoor side to outdoor side.

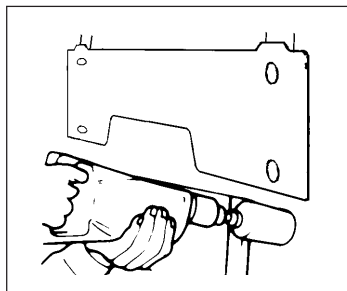

(b) Adjusting sleeve length

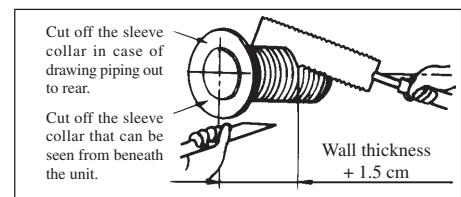

(c) Install the sleeve

(Inserting sleeve)

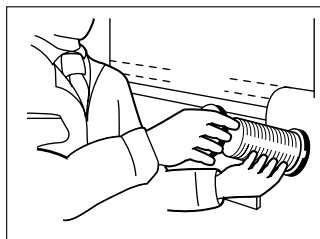

(*Sleeve + *Inclined + *Sealing plate)

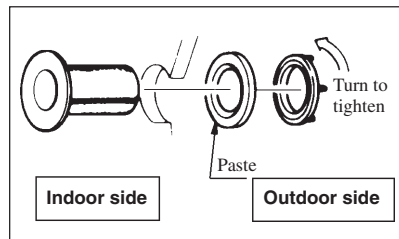

View of sleeve when installed

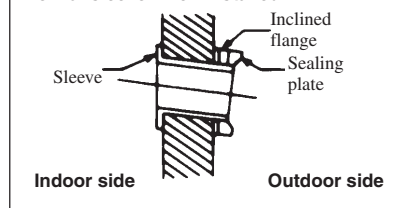

(3) Preparation of indoor unit

(a) Mounting of connecting wires

- 1) Remove the lid(R).
- 2) Remove the wiring clamp.
- 3) Connect the connecting wire securely to the terminal block.

Use cables for interconnection wiring to avoid loosening of the wires.
 CENELEC code for cables. Required field cables.
 H05RNR4G1.5 (Example) or 245IEC57

H Harmonized cable type
 05 300/500 volts
 R Natural-and/or synth, rubber wire insulation
 N Polychloroprene rubber conductors insulation
 R Standed core
 4or5 Number of conductors
 G One conductor of the cable is the earth conductor (yellow/green)
 1.5 Section of copper wire (mm²)

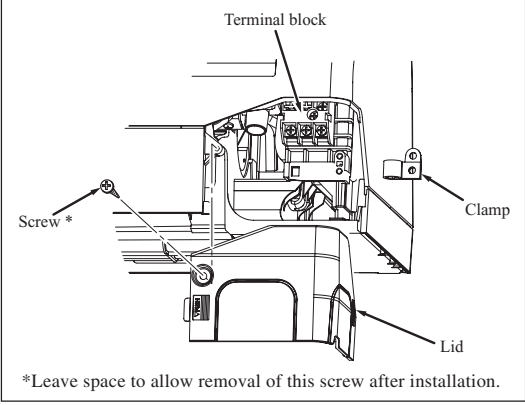

- ① Connect the connection wire securely to the terminal block. If the wire is not affixed completely, contact will be poor, and it is dangerous as the terminal block may heat up and catch fire.
 - ② Take care not to confuse the terminal numbers for indoor and outdoor connections.
 - ③ Affix the connection wire using the wiring clamp.
- 4) Fix the connecting wire by wiring clamp.
 - 5) Attach the lid.
 - 6) Close the air inlet panel.

(b) Installing the support of piping

[Shaping the piping]

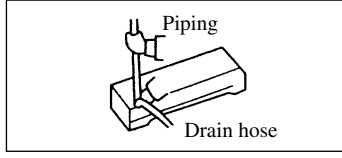

- Hold the bottom of the piping and fix direction before stretching it and shaping it.

[Taping of the exterior]

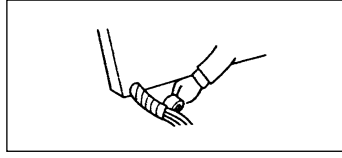

- Tape only the portion that goes through the wall. Always tape the crossover wiring with the piping.

[Matters of special notice when piping from left or center/rear of the unit.]

[Top View]

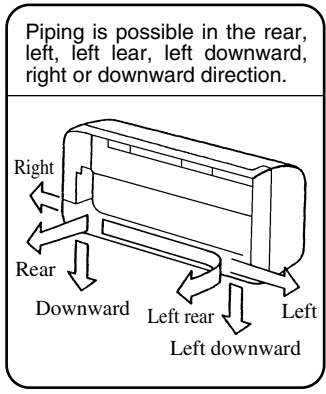
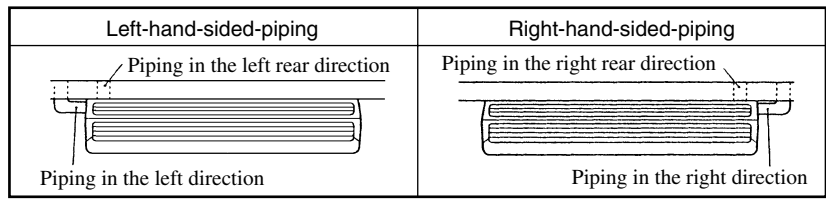

[Drain hose changing procedures]

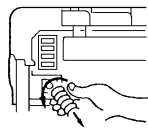
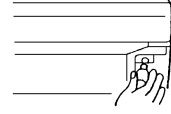
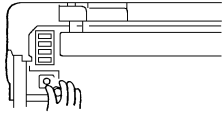
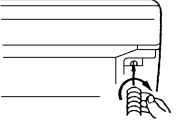
1. Remove the drain hose.	2. Remove the drain cap.	3. Insert the drain cap.	4. Connect the drain hose.
			

- Remove the drain hose, making it rotate.
- Remove it with hand or pliers.
- Insert the drain cap which was removed at procedure "2" securely using a hexagonal wrench, etc.
Note: Be careful that if it is not inserted securely, water leakage may occur.
- Insert the drain hose securely, making it rotate.
Note: Be careful that if it is not inserted securely, water leakage may occur.

Since this air conditioner has been designed to collect dew drops on the rear surface to the drain pan, do not attach the power cord above the gutter.

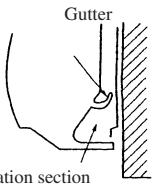

Pipe accommodation section

Drainage

- Arrange the drain hose in a downward angle.
- Avoid the following drain piping.

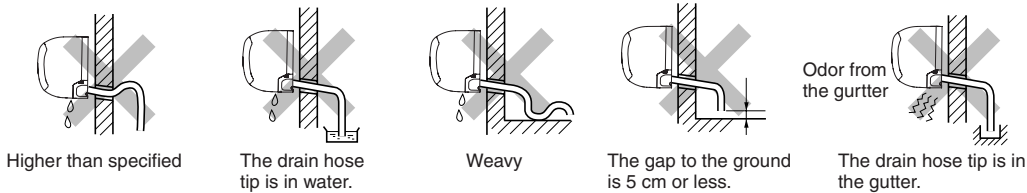

- Pour water to the drain pan located under the heat exchanger, and ensure that the water is discharged outdoor.
- When the extended drain hose is indoor, always use a shield pipe (to be arranged by the user) and ensure it is thermally insulated.

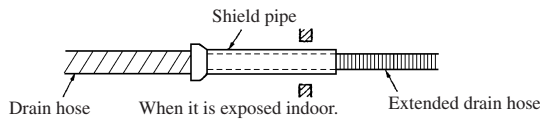

(c) Fixing of indoor unit

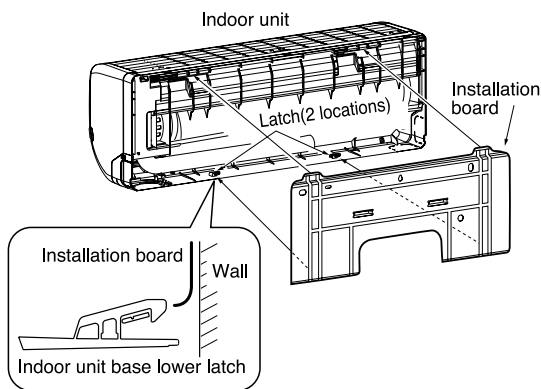

Installation Steps

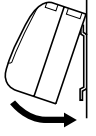
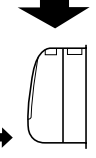
- ① Pass the pipe through the hole in the wall, and hook the upper part of the indoor unit to the installation board. 
- ② Gently push the lower part to secure the unit. 

- How to remove the indoor unit from the installation board
 - ① Push up at the marked portion of the indoor unit base lower latch, and slightly pull it toward you. (both right and left hand sides)
(The indoor unit base lower latch can be removed from the installation board)
 - ② Push up the indoor unit upward. So the indoor unit will be removed from the installation board.

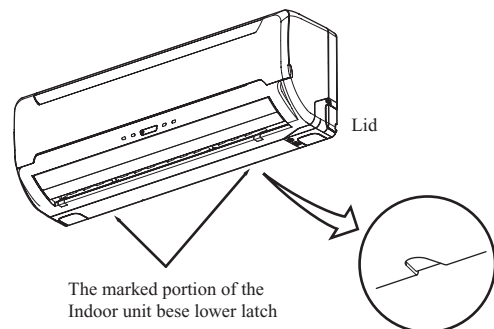

5.3 Installation of outdoor unit

(1) Installation of outdoor unit

- Make sure that the unit is stable in installation. Fix the unit to stable base.
- When installing the unit at a higher place or where it could be toppled by strong winds, secure the unit firmly with foundation bolts, wire, etc.
- Perform wiring, making wire terminal numbers conform to terminal numbers of indoor unit terminal block.
- Connect using ground screw located near \oplus mark.
- In areas where the temperatures drop below 0°C for several continuous days, do not install a drain elbow.
(Water discharge could stop due to freezing.)

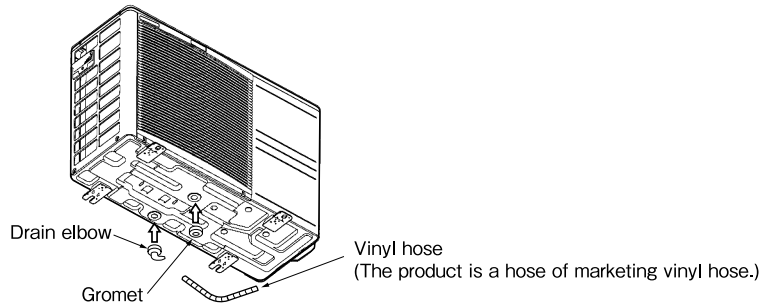

5.4 Connection of refrigerant pipings

(1) Preparation

Keep the openings of the pipes covered with tapes etc. to prevent dust, sand, etc. from entering them.

(a) Indoor unit side

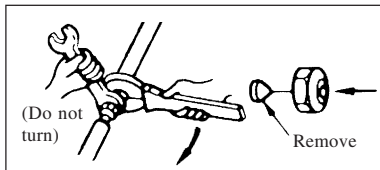

- Remove the flared nuts.
(on both liquid and gas sides)

(b) Outdoor unit side

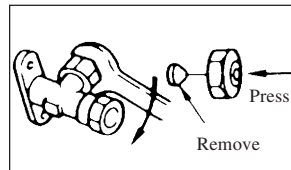

- Remove the flared nuts.
(on both liquid and gas sides)

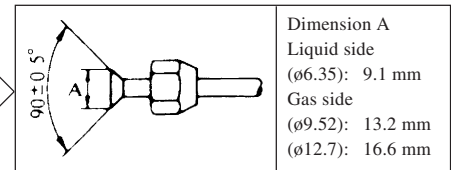

- Install the removed flared nuts to the pipes to be connected, then flare the pipes.

Dimension A	
Liquid side (ø6.35)	9.1 mm
Gas side (ø9.52)	13.2 mm
Gas side (ø12.7)	16.6 mm

(2) Connection of refrigerant piping

(a) Indoor unit side

- Connect firmly gas and liquid side pipings by Torque wrench.

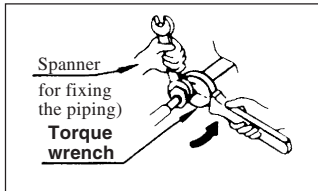

- Specified torquing value:
Liquid side (ø6.35) : 14~18N·m (1.4~1.8kgf·m)
Gas side (ø9.52) : 34~42N·m (3.4~4.2kgf·m)
Gas side (ø12.7) : 49~61N·m (4.9~6.1kgf·m)

(b) Outdoor unit side

- Connect firmly gas and liquid side pipings by Torque wrench.

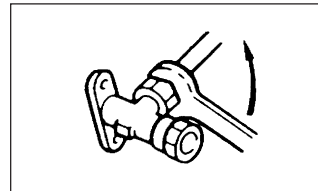

- Specified torquing value:
Liquid side (ø6.35) : 14~18N·m (1.4~1.8kgf·m)
Gas side (ø9.52) : 34~42N·m (3.4~4.2kgf·m)
Gas side (ø12.7) : 49~61N·m (4.9~6.1kgf·m)
- Use one more spanner to fix the valve.
- Always use a Torque wrench and back up spanner to tighten the flare nut.

(3) Air purge

- (a) Tighten all flare nuts in the pipings both indoor and outside will so as not to cause leak.
- (b) Connect service valve, charge hose, manifold valve and vacuum pump as is illustrated below.
- (c) Open manifold valve handle Lo to its full width, and perform vacuum or evacuation.
Continue the vacuum or evacuation operation for 15 minutes or more and check to see that the vacuum gauge reads -0.1 MPa (-76 cmHg).
- (d) After completing vacuum operation, fully open service valve (Both gas and liquid sides) with hexagon headed wrench.
- (e) Detach the charge hoses.
- (f) Check for possible leakage of gas in the connection parts of both indoor and outdoor.

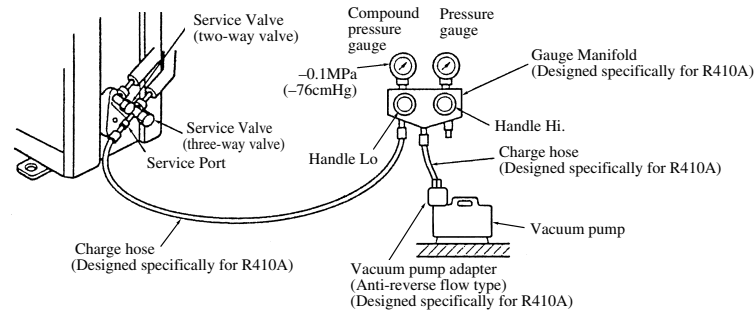

- Since the system uses service ports differing in diameter from those found on the conventional models, a charge hose (for R22) presently in use is not applicable.
Please use one designed specifically for R410A
- Please use an anti-reverse flow type vacuum pump adapter so as to prevent vacuum pump oil from running back into the system.
Oil running back into an air-conditioning system may cause the refrigerant cycle to break down.

Additional refrigerant charge

● 20, 25, 35 type

Additional refrigerant charge is not required at all.

● 50 type

When refrigerant piping exceeds 15m conduct additional refrigerant charge by weight after refrigerant piping completion.
Additional charge amount per meter = 20g/m

[Example]

How much amount of additional charge for 25m piping?

$$(25 - 15)m \times 20g/m = 200g \quad \boxed{200g \text{ for additional charge}}$$

(4) Insulation of connecting portion

- (a) Cover the connecting portion of the refrigerant piping with the pipe cover and seal them.
If neglecting to do so, moisture occurs on the piping and water will drip out.

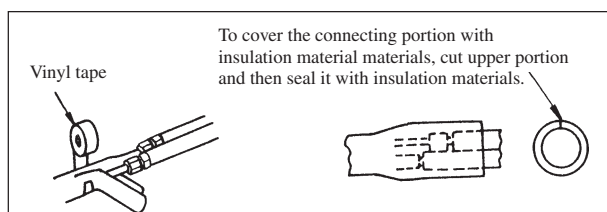

(b) Finishing and fixing

- 1) Tie up the piping with wrapping tape, and shape it so that it conforms to which the pipe is attached.
- 2) Fix them with clamps as right figure.

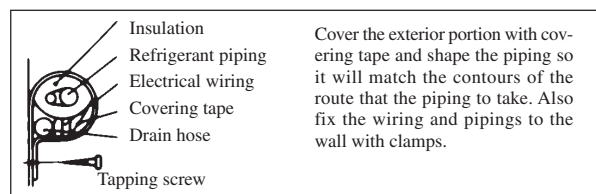

5.5 Test run

- (1) Conduct trial run after confirming that there is no gas leaks.
- (2) When conducting trial run set the remote control thermostat to continuous operation position. However when the power source is cut off or when the unit's operation switch is turned off or was turned to fan operation position, the unit will not go into operation in order to protect the compressor.
- (3) Explain to the customer on the correct usage of the air conditioner in simple layman's terms.
- (4) Make sure that drain flows properly.
- (5) **Standard operation data** (220/230/240V)

Item	Model	SRK20ZG-S	SRK25ZG-S	SRK35ZG-S	SRK50ZG-S
	High pressure (MPa)	Cooling	–	–	–
Heating		2.5~2.7	2.5~2.7	2.8~3.0	3.2~3.3
Low pressure (MPa)	Cooling	0.9~1.1	0.9~1.1	0.8~1.0	0.7~0.9
	Heating	–	–	–	–
Temp. difference between return air and supply air (°C)	Cooling	13~15	13~15	13~15	14~16
	Heating	18~20	18~20	18~20	24~26
Running current (A)	Cooling	2.4/2.3/2.2	3.1/3.0/2.9	4.9/4.7/4.5	7.6/7.3/7.0
	Heating	3.0/2.9/2.8	4.5/4.3/4.1	5.3/5.1/4.9	7.9/7.5/7.2

Note (1) The data are measured at following conditions

Ambient air temperature

Indoor side: Cooling ... 27°C DB, 19°C WB, Heating ... 20°C DB

Outdoor side: Cooling ... 35°C DB, 24°C WB, Heating ... 7°C DB, 6°C WB

5.6 Precautions for wireless remote control installation and operation

- (1) **Wireless remote control covers the following distances:**
 - (a) **When operating facing the air conditioner:**

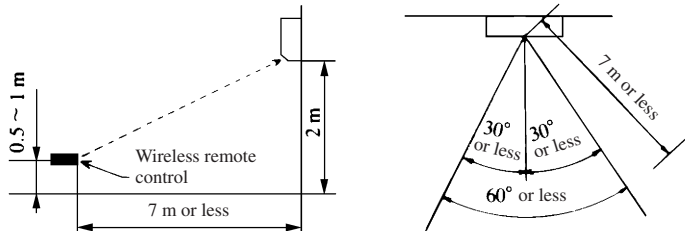

If the distances exceed the area indicated above, be sure to check the receiver status.

- (b) **When manipulating the remote control mounted on a wall:**

Make sure that it works normally (i.e., transmission/reception signal is audible) before mounting.

- Notes (1) The remote control is correctly facing the sensing element of the air conditioner when being manipulated.
- (2) The typical coverage is indicated (in the left illustration). It may be more or less depending on the installation.
- (3) The coverage may be less or even nil. If the sensing element is exposed to strong light, such as direct sunlight, illumination, etc., or dust is deposited on it or it is used behind a curtain, etc.

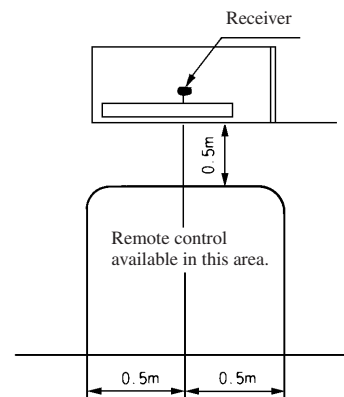

6 MAINTENANCE DATA

6.1 Troubleshooting procedures for electrical equipment

(1) Cautions

- ① If you are disassembling and checking an air conditioner, be sure to turn off the power before beginning. When working on indoor units, let the unit sit for about 1 minute after turning off the power before you begin work. When working on an outdoor unit, there may be an electrical charge applied to the main circuit (electrolytic condenser), so begin work only after discharging this electrical charge (to DC 10 V or lower).
- ② When taking out printed circuit boards, be sure to do so without exerting force on the circuit boards or package components.
- ③ When disconnecting and connecting connectors, take hold of the connector housing and do not pull on the lead wires.

(2) Items to check before troubleshooting

- ① Have you thoroughly investigated the details of the trouble which the customer is complaining about?
- ② Is the air conditioner running? Is it displaying any self-diagnosis information?
- ③ Is a power supply with the correct voltage connected?
- ④ Are the control lines connecting the indoor and outdoor units wired correctly and connected securely?
- ⑤ Is the outdoor unit's refrigerant service valve open?

(3) Troubleshooting procedure (If the air conditioner does not run at all)

If the air conditioner does not run at all, diagnose the trouble using the following troubleshooting procedure. If the air conditioner is running but breaks down, proceed to troubleshooting step (4).

Important When all the following conditions are met, we say that the air conditioner will not run at all.

- ① The RUN light does not light up.
- ② The flaps do not open.
- ③ The indoor unit fan motors do not run.
- ④ The self-diagnosis display does not function.

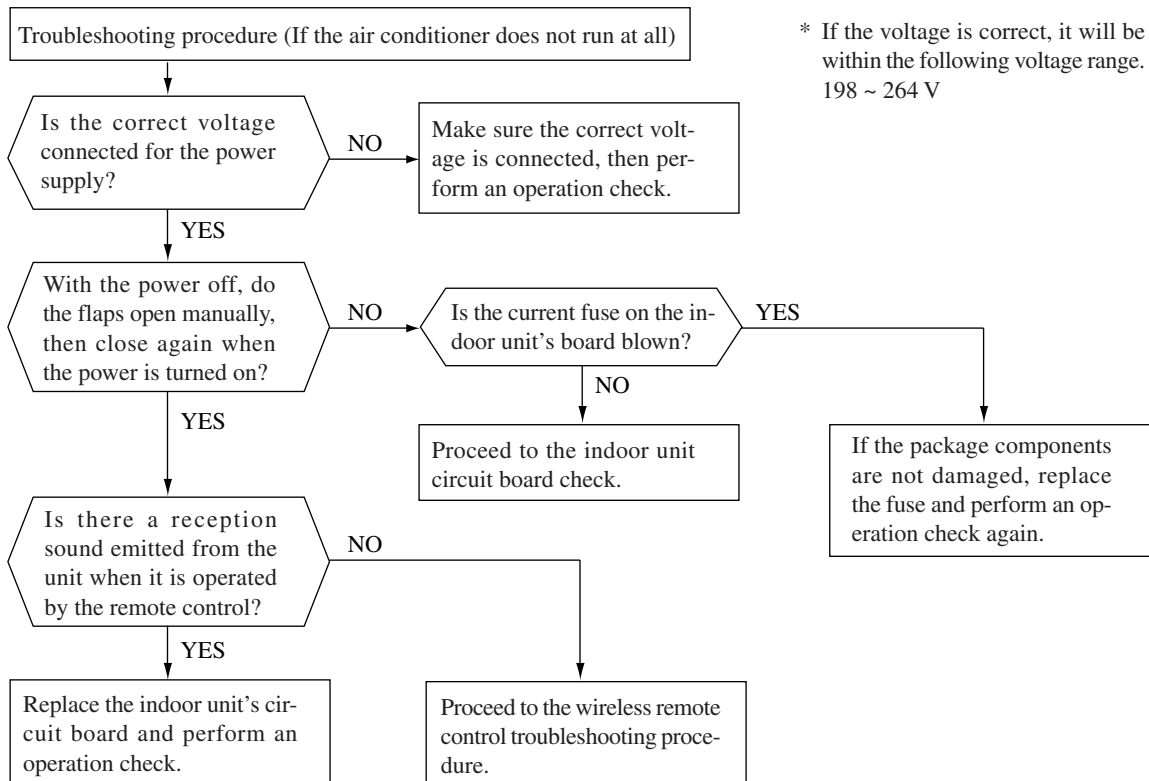

(4) Troubleshooting procedure (If the air conditioner runs)

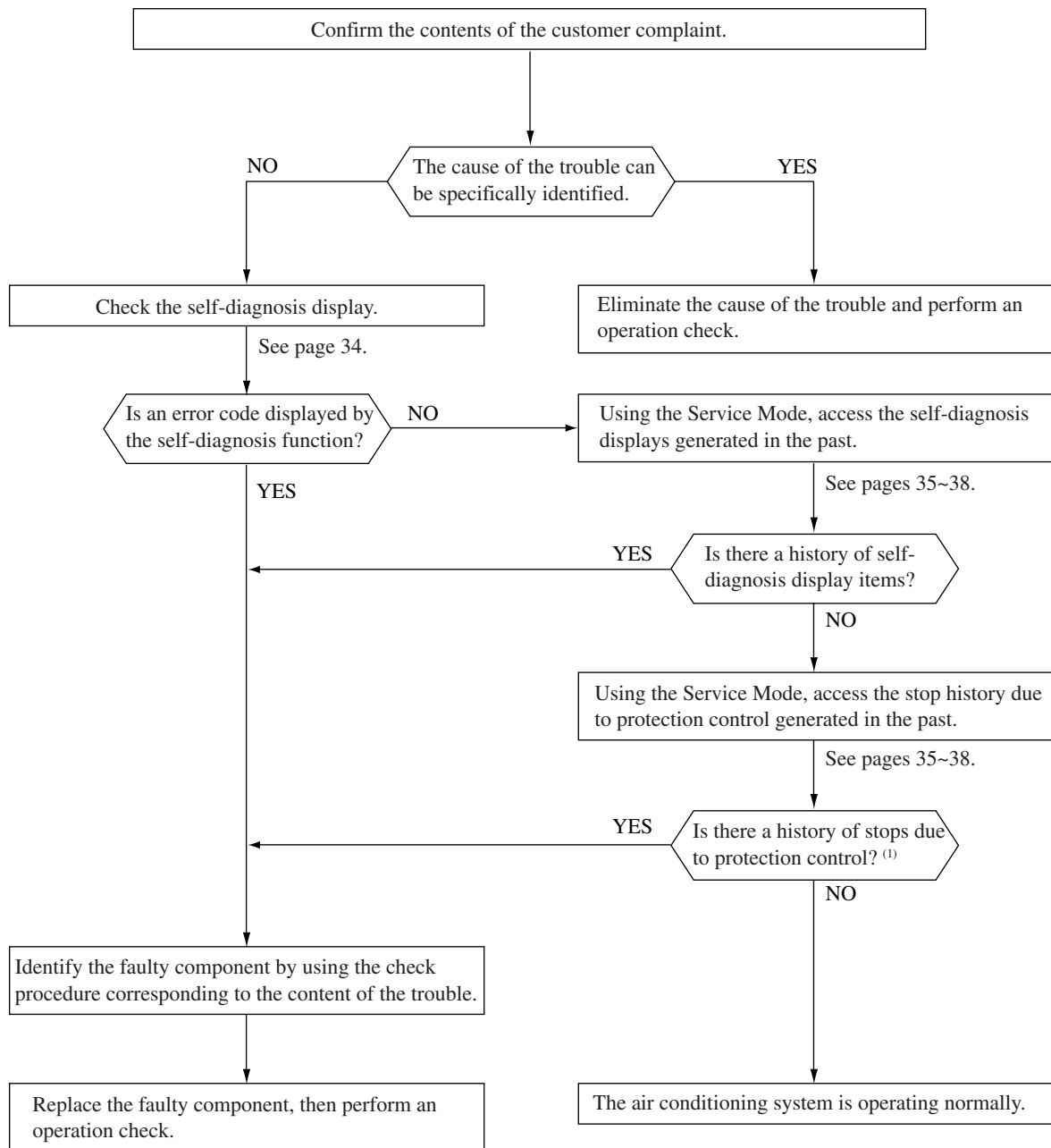

Note (1) Even in cases where only intermittent stop data are generated, the air conditioning system is normal. However, if the same protective operation recurs repeatedly (3 or more times), it will lead to customer complaints. Judge the conditions in comparison with the contents of the complaints.

(5) Self-diagnosis table

When this air conditioner performs an emergency stop, the reason why the emergency stop occurred is displayed by the flashing of display lights. If the air conditioner is operated using the remote control 3 minutes or more after the emergency stop, the trouble display stops and the air conditioner resumes operation. ⁽¹⁾

Indoor unit display panel		Wired remote control display	Description of trouble	Cause	Display (flashing) condition
RUN light	TIMER light				
1 time flash	ON	E 6	Heat exchanger sensor error	• Broken heat exchanger sensor wire, poor connector connection	When a heat exchanger sensor wire disconnection is detected while operation is stopped. (If a temperature of -20°C or lower is detected for 15 seconds, it is judged that the wire is disconnected.) (Not displayed during operation.)
2 time flash	ON	E 7	Room temperature sensor error	• Broken room temperature sensor wire, poor connector connection	When a room temperature sensor wire disconnection is detected while operation is stopped. (If a temperature of -20°C or lower is detected for 15 seconds, it is judged that the wire is disconnected.) (Not displayed during operation.)
6 time flash	ON	E 16	Indoor fan motor error	• Defective fan motor, poor connector connection	When conditions for turning the indoor unit's fan motor on exist during air conditioner operation, an indoor unit fan motor speed of 300 rpm or lower is measured for 30 seconds or longer. (The air conditioner stops.)
Keeps flashing	1 time flash	E 38	Outdoor air temperature sensor error	• Broken outdoor air temp. sensor wire, poor connector connection	When an outdoor temperature sensor wire disconnection is detected while operation is stopped. (If a temperature of -40°C or lower is detected for 15 seconds, it is judged that the wire is disconnected.) (Not displayed during operation.)
Keeps flashing	2 time flash	E 37	Outdoor heat exchanger sensor error	• Broken heat exchanger sensor wire, poor connector connection	When a sensor wire disconnection is detected while operation is stopped. (If a temperature of -50°C or lower is detected for 15 seconds, it is judged that the wire is disconnected.) (Not displayed during operation.)
Keeps flashing	4 time flash	E 39	Discharge pipe sensor error	• Broken discharge pipe sensor wire, poor connector connection	When a compressor discharge pipe sensor wire disconnection is detected for 15 seconds or longer (less than 7°C) after the outdoor unit's speed has continued at 0 rps or higher for 9 minutes. (The air conditioner stops.)
ON	1 time flash	E 42	Current Cut	• Compressor locking, open phase on compressor output, shortcircuit on power transistor, closed service valve	The inverter output current (compressor motor current) exceeds the set value during compressor start. (The air conditioner stops.)
ON	2 time flash	E 59	Trouble of outdoor unit	• Broken compressor wire • Broken discharge pipe sensor wire, poor connector connection • Compressor blockage	When there is an emergency stop caused by trouble in the outdoor unit, or the input current value is found to be lower than the set value continuously for 3 minutes or longer. (The air conditioner stops.)
ON	3 time flash	E 58	Current safe stop	• Overload operation • Overcharge • Compressor locking	When the inverter command speed is 20 rps or less and the current safe has operated. (the compressor stops)
ON	5 time flash	E 41	Power transistor error	• Broken power transistor	When there is an emergency stop caused by trouble in the outdoor unit, or the input current value is found to be lower than the set value continuously for 3 minutes or longer. (The air conditioner stops.)
ON	5 time flash	E 36	Over heat of compressor	• Gas shortage, defective discharge pipe sensor, closed service valve	When the value of the discharge pipe sensor exceeds the set value. (The air conditioner stops.)
ON	6 time flash	E 5	Error of signal transmission	• Defective power supply, Broken signal wire, defective in/outdoor unit boards	When there is no signal between the indoor unit's board and outdoor unit's board for 10 seconds or longer (when the power is turned on), or when there is no signal for 1 minute 50 seconds or longer (during operation)(the compressor is stopped).
ON	7 time flash	E 48	Outdoor fan motor error	• Defective fan motor, poor connector connection	When the outdoor unit's fan motor speed continues for 30 seconds or longer at 75 rpm or lower. (3 times) (The air conditioner stops.)
2 time flash	2 time flash	E 60	Rotor lock	• Defective compressor • Open phase on compressor • Defective outdoor unit boards	If the compressor motor's magnetic pole positions cannot be correctly detected when the compressor starts. (The air conditioner stops.)
—	—	E 1	Error of wired remote control wiring	• Broken wired remote control wire, defective indoor unit boards	The wired remote control wire Y is open. The wired remote control wires X and Y are reversely connected. Noise is penetrating the wired remote control lines. The wired remote control or indoor control PCB is faulty. (The communications circuit is faulty.)

Notes (1)The air conditioner cannot be restarted using the remote control for 3 minutes after operation stops.

(2)The wired remote control is optional parts.

(6) Service mode (Trouble mode access function)

This air conditioner is capable of recording error displays and protective stops (service data) which have occurred in the past. If self-diagnosis displays cannot be confirmed, it is possible to get a grasp of the conditions at the time trouble occurred by checking these service data.

(a) Explanation of terms

Term	Explanation
Service mode	The service mode is the mode where service data are displayed by flashing of the display lights when the operations in item (b) below are performed with the indoor controller.
Service data	These are the contents of error displays and protective stops which occurred in the past in the air conditioner system. Error display contents and protective stop data from past anomalous operations of the air conditioner system are saved in the indoor unit controller's non-volatile memory (memory which is not erased when the power goes off). There are two types of data, self-diagnosis data and stop data, described below.
Self-diagnosis data	These are the data which display the reason why a stop occurred when an error display (self-diagnosis display) occurred in an indoor unit. Data are recorded for up to 5 previous occurrences. Data which are older than the 5th previous occurrence are erased. In addition, data on the temperature of each sensor (room temperature, indoor heat exchanger, outdoor heat exchanger, outdoor air temperature, discharge pipe), remote control information (operation switching, fan speed switching) are recorded when trouble occurs, so more detailed information can be checked.
Stop data	These are the data which display the reason by a stop occurred when the air conditioning system performed protective stops, etc. in the past. Even if stop data alone are generated, the system restarts automatically. (After executing the stop mode while the display is normal, the system restarts automatically.) Data for up to 10 previous occasions are stored. Data older than the 10th previous occasion are erased. (Important) In cases where transient stop data only are generated, the air conditioner system may still be normal. However, if the same protective stop occurs frequently (3 or more times), it could lead to customer complaints.

(b) Service mode display procedure

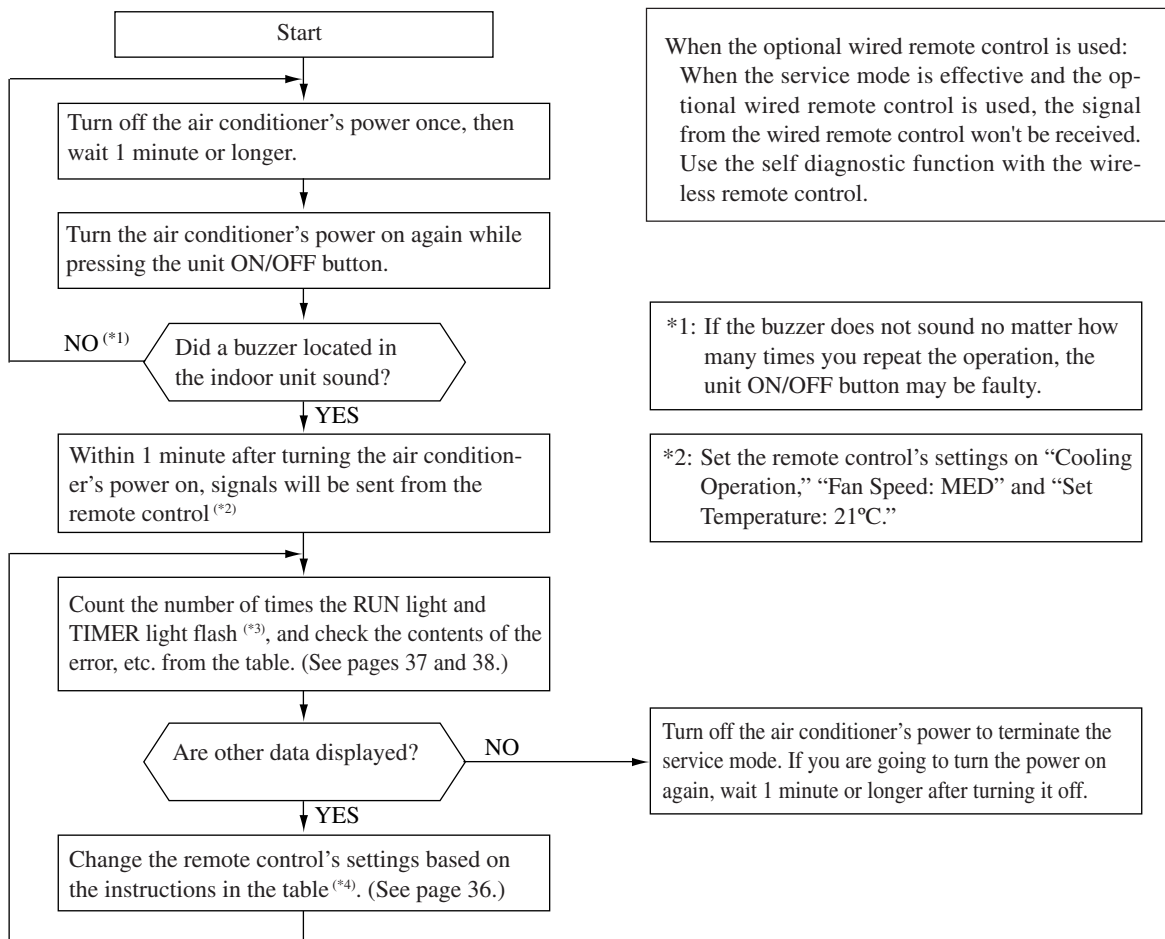

*3: To count the number of flashes in the service mode, count the number of flashes after the light lights up for 1.5 second initially (start signal). (The time that the light lights up for 1.5 second (start signal) is not counted in the number of flashes.)

- In the case of current safe (heating CT1) (example: stop code “32”)
 - The RUN light (10’s digit) flashes 3 times and the TIMER light (1’s digit) flashes 2 times.
 - $3 \times 10 + 2 \times 1 = 32 \rightarrow$ From the table, read the instructions for error code 32, “current safe (heating CT1).

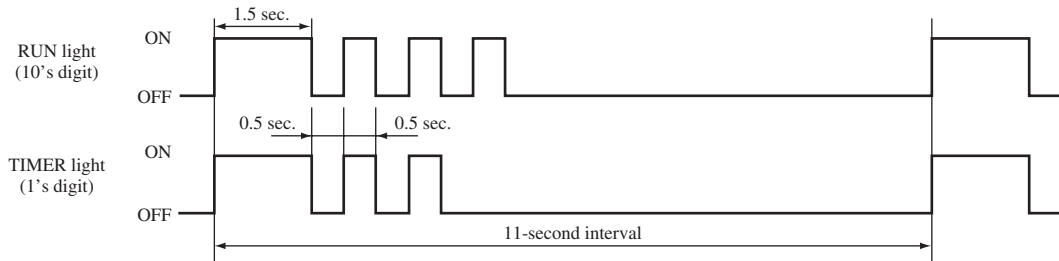

*4: When in the service mode, when the remote control’s settings (operation switching, fan speed switching, temperature setting) are set as shown in the following table and sent to the air conditioner unit, the unit switches to display of service data.

① **Self-diagnosis data**

What are Self- These are control data (reasons for stops, temperature at each sensor, remote control information) diagnosis Data? from the time when there were error displays (abnormal stops) in the indoor unit in the past. Data from up to 5 previous occasions are stored in memory. Data older than the 5th previous occasion are erased. The temperature setting indicates how many occasions previous to the present setting the error display data are and the operation switching and fan speed switching data show the type of data.

Remote control setting		Contents of output data
Operation switching	Fan speed switching	
Cooling	MED	Displays the reason for stopping display in the past (error code).
	HI	Displays the room temperature sensor temperature at the time the error code was displayed in the past.
	AUTO	Displays the indoor heat exchanger sensor temperature at the time the error code was displayed in the past.
Heating	LO	Displays the remote control information at the time the error code was displayed in the past.
	MED	Displays the outdoor air temperature sensor temperature at the time the error code was displayed in the past.
	HI	Displays the outdoor heat exchanger sensor temperature at the time the error code was displayed in the past.
	AUTO	Displays the discharge pipe sensor temperature at the time the error code was displayed in the past.

Remote control setting	Indicates the number of occasions previous to the present the error display data are from.
Temperature setting	
21°C	1 time previous (previous time)
22°C	2 times previous
23°C	3 times previous
24°C	4 times previous
25°C	5 times previous

(Example)

Remote control setting			Displayed data
Operation switching	Fan speed switching	Temperature setting	
Cooling	MED	21°C	Displays the reason for the stop (error code) the previous time an error was displayed.
		22°C	Displays the reason for the stop (error code) 2 times previous when an error was displayed.
		23°C	Displays the reason for the stop (error code) 3 times previous when an error was displayed.
		24°C	Displays the reason for the stop (error code) 4 times previous when an error was displayed.
		25°C	Displays the reason for the stop (error code) 5 times previous when an error was displayed.

② Stop data

Remote control setting			Displayed data
Operation switching	Fan speed switching	Temperature setting	
Cooling	LO	21°C	Displays the reason for the stop (stop code) the previous time when the air conditioner was stopped by protective stop control.
		22°C	Displays the reason for the stop (stop code) 2 times previous when the air conditioner was stopped by protective stop control.
		23°C	Displays the reason for the stop (stop code) 3 times previous when the air conditioner was stopped by protective stop control.
		24°C	Displays the reason for the stop (stop code) 4 times previous when the air conditioner was stopped by protective stop control.
		25°C	Displays the reason for the stop (stop code) 5 times previous when the air conditioner was stopped by protective stop control.
		26°C	Displays the reason for the stop (stop code) 6 times previous when the air conditioner was stopped by protective stop control.
		27°C	Displays the reason for the stop (stop code) 7 times previous when the air conditioner was stopped by protective stop control.
		28°C	Displays the reason for the stop (stop code) 8 times previous when the air conditioner was stopped by protective stop control.
		29°C	Displays the reason for the stop (stop code) 9 times previous when the air conditioner was stopped by protective stop control.
		30°C	Displays the reason for the stop (stop code) 10 times previous when the air conditioner was stopped by protective stop control.

(c) Error code, stop code table (Assignment of error codes and stop codes is done in common for all models.)

Number of flashes when in service mode		Stop code or Error code	Error content		Cause	Occurrence conditions	Error display	Auto recovery
RUN light (10's digit)	TIMER light (1's digit)		Major category	Minor category				
OFF	OFF	0	Normal	—	—	—	—	—
1 time flash	1 time flash	11	Current Cut	Compressor Software Start	Compressor lock Compressor wiring short circuit Compressor output is open phase Outdoor unit's circuit board is faulty	Compressor start fails 42 times in succession and the reason for the final failure is current cut.	○ (2 times)	○
	2 time flash	12		Lower than 20 rps	Service valve closed Compressor output is open phase. Electronic expansion valve is faulty.	After the compressor starts, it stops due to current cut at less than 20 rps.	—	○
	3 time flash	13		20 rps or higher	Service valve is closed. Compressor output is open phase. Compressor is faulty. Electronic expansion valve is faulty.	When operation is stopped by current cut at 20 rps or higher.	—	○
	4 time flash	14		Excessive voltage (DC 350 V)	Outdoor unit's circuit board is defective. Power supply is abnormal.	When the DC voltage (DC 280 V) exceeds 350 V.	—	○
	5 time flash	15		Short circuit in the power transistor (high side)	Outdoor unit's circuit board is faulty. Power transistor is damaged.	When it is judged that the power transistor was damaged at the time the compressor started.	○	—
	6 time flash	16		Current cut circuit breakdown	Outdoor unit's circuit board is faulty. Power transistor is damaged.	When it is judged that the power transistor was damaged at the time the compressor started.	○	—
2 time flash	1 time flash	21	Outdoor unit error	PWM calculation results are abnormal.	Compressor wiring is disconnected. Power transistor is damaged.	When PWM calculation results of 0% continue for 3 minutes or longer.	○	—
	2 time flash	22		Input is 2A or lower (PWM 90% or higher)	Compressor wiring is disconnected. Outdoor unit's circuit board is faulty.	When PWM calculation results of 90% and an input current lower than the set value continue for 3 minutes or longer.	○	—
	3 time flash	23		Abnormal stop 3 times in 20 minutes.	Service valve is closed. Compressor output is open phase. Electronic expansion valve is faulty. Refrigerant is insufficient.	When an abnormal stop occurs 3 times with automatic recovery within 20 minutes after the outdoor unit's power supply was turned on.	○	—
	9 time flash	29		Voltage drop	Power supply construction is defective. Outdoor unit's circuit board is faulty.	When the power supply voltage drops during operation.	—	○
	7 time flash	27	Outdoor fan motor error	Outdoor unit's fan motor is abnormal	Outdoor fan motor is faulty. Connector connections are poor. Outdoor unit's circuit board is faulty.	When a fan speed of 75 rpm or lower continues for 30 seconds or longer.	○ (3 times)	○
3 time flash	1 time flash	31	Current safe	Cooling current safe I	Overcharge Compressor lock	When there is a current safe stop in current safe I mode during cooling operation.	—	○
	2 time flash	32		Heating current safe I	Overcharge Compressor lock	When there is a current safe stop in current safe I mode during heating operation.	—	○
	3 time flash	33		Cooling current safe II	Overcharge Compressor lock	When there is a current safe stop in current safe II mode during cooling operation.	—	○
	4 time flash	34		Heating current safe II	Overcharge Compressor lock	When there is a current safe stop in current safe II mode during heating operation.	—	○
	5 time flash	35		Cooling current safe III	Overcharge Compressor lock	When there is a current safe stop in current safe III mode during cooling operation.	—	○
	6 time flash	36		Heating current safe III	Overcharge Compressor lock	When there is a current safe stop in current safe III mode during heating operation.	—	○
	7 time flash	37		Heating current safe III + 3A	Overcharge Compressor lock	When there is a current safe stop in current safe III + 3A mode during heating operation.	—	○

Number of flashes when in service mode		Stop code or Error code	Error content		Cause	Occurrence conditions	Error display	Auto recovery
RUN light (10's digit)	TIMER light (1's digit)		Major category	Minor category				
4 time flash	1 time flash	41	Current safe	Cooling overload 1 (outdoor temperature: 36~40°C)	Overcharge Compressor lock Overload operation	When there is a current safe stop in overload 1 mode during cooling operation.	—	○
	2 time flash	42		Heating overload 1 (outdoor temperature: 5~12°C)	Overcharge Compressor lock Overload operation	When there is a current safe stop in overload 1 mode during heating operation.	—	○
	3 time flash	43		Cooling overload 2 (outdoor temperature: 40~45°C)	Overcharge Compressor lock Overload operation	When there is a current safe stop in overload 2 mode during cooling operation.	—	○
	4 time flash	44		Heating overload 2 (outdoor temperature: 12~17°C)	Overcharge Compressor lock Overload operation	When there is a current safe stop in overload 2 mode during heating operation.	—	○
	5 time flash	45		Cooling overload 3 (outdoor temperature: 45°C~)	Overcharge Compressor lock Overload operation	When there is a current safe stop in overload 3 mode during cooling operation.	—	○
	6 time flash	46		Heating overload 3 (outdoor temperature: 17°C~)	Overcharge Compressor lock Overload operation	When there is a current safe stop in overload 3 mode during heating operation.	—	○
5 time flash	OFF	50	Compressor overheat	110°C(50Z) 125°C(20~35Z)	Refrigerant is insufficient. Discharge pipe sensor is faulty. Service valve is closed.	When the discharge pipe sensor's value exceeds the set value.	○ (2 times)	○
6 time flash	OFF	60	Serial signal transmission error	Can't receive signals for 1 minute 55 seconds (if communications have recovered)	Power supply is faulty. Power supply cables and signal lines are improperly wired. Indoor or outdoor unit circuit board is faulty.	When 1 minute 55 seconds passes without communications signals from either the outdoor unit or the indoor unit being detected correctly.	—	○
	1 time flash	61		Connection lines between the indoor and outdoor units are faulty.	Connection lines between the indoor and outdoor units are faulty. Indoor or outdoor unit circuit boards are faulty.	When 10 seconds passes after the power is turned on without communications signals from the indoor or outdoor unit being detected correctly.	○	—
	2 time flash	62		Serial transmission error.	Indoor or outdoor unit circuit boards are faulty. Noise is causing faulty operation.	When 1 minute 50 seconds passes without communications signals from either the outdoor unit or the indoor unit being detected correctly.	○ (3 times)	○
7 time flash	1 time flash	71	Rotor lock	Less than 16 rps	Compressor is faulty Compressor output is open phase Electronic expansion valve is faulty. Overload operation Outdoor unit circuit board is faulty.	After the compressor starts, when the compressor stops at less than 16 rps due to rotor lock.	—	○
	2 time flash	72		16 rps or higher	Compressor is faulty Compressor output is open phase Electronic expansion valve is faulty. Overload operation Outdoor unit circuit board is faulty.	When the compressor stops at 16 rps or higher speed due to rotor lock.	—	○
	3 time flash	73		Phase switching defects (U phase)	Compressor is faulty Compressor wiring is disconnected. Compressor wiring is short circuited. Outdoor unit's circuit board is faulty.	When compressor start fails 42 times in succession and the reason for the final failure is rotor lock.	○ (2 times)	○
	4 time flash	74		Phase switching defects (V phase)	Compressor is faulty Compressor wiring is disconnected. Compressor wiring is short circuited. Outdoor unit's circuit board is faulty.	When compressor start fails 42 times in succession and the reason for the final failure is rotor lock.	○ (2 times)	○
	5 time flash	75		Phase switching defects (W phase or impossible to distinguish).	Compressor is faulty Compressor wiring is disconnected. Compressor wiring is short circuited. Outdoor unit's circuit board is faulty.	When compressor start fails 42 times in succession and the reason for the final failure is rotor lock.	○ (2 times)	○
	6 time flash	76		Compressor software start (within 4 seconds after phase switching)	Compressor is faulty Compressor wiring is disconnected. Compressor wiring is short circuited. Outdoor unit's circuit board is faulty.	When compressor start fails 42 times in succession and the reason for the final failure is rotor lock.	○ (2 times)	○
8 time flash	OFF	80	Protective control operation	Indoor unit fan motor is abnormal.	Fan motor is faulty. Connector connections are poor. Indoor unit circuit board is faulty.	When the indoor unit's fan motor is detected to be running at 300 rpm or lower speed with the fan motor in the ON condition while the air conditioner is running.	○	—
	1 time flash	81		Discharge pipe sensor is abnormal (anomalous stop).	Discharge pipe sensor wire is disconnected. Connector connections are poor.	When a disconnection signal (temperature below 7°C) is sent for 15 seconds or longer as the discharge pipe sensor data after the outdoor unit's speed is 0 rps or higher continuously for 9 minutes.	○ (4 times)	○
	2 time flash	82		Indoor heat exchanger sensor is abnormal (anomalous stop).	Indoor heat exchanger sensor wire is disconnected. Connector connections are poor.	When a temperature of -20°C or lower is sensed continuously for 40 minutes during heating operation (the compressor stops).	○	—
	3 time flash	83		Outdoor heat exchanger sensor is abnormal (anomalous stop).	Outdoor heat exchanger sensor wire is disconnected. Connector connections are poor.	When a temperature of -50°C or lower is sensed continuously for 40 minutes during heating operation (the compressor stops).	○	—
	4 time flash	84		Anti-condensation control	High humidity condition. Humidity sensor is faulty.	Anti-condensation prevention control is operating.	—	○
	5 time flash	85		Anti-frost control	Indoor unit fan speed drops. Indoor heat exchanger sensor short circuit	When the anti-frost control operates and the compressor stops during cooling operation.	—	○
	6 time flash	86		High pressure control	Heating overload Indoor unit fan speed drops Indoor heat exchanger sensor short circuit	When high pressure control operates during heating operation and the compressor stops.	—	○
	7 time flash	87		Compressor overheating protection control	Refrigerant is insufficient. Discharge pipe sensor is faulty. Service valve is closed.	When compressor overheating protective control operates and the compressor stops.	—	○
	8 time flash	88		Refrigeration cycle system protective control	Service valve is closed. Refrigerant is insufficient.	When refrigeration cycle system protective control operates.	—	○

Note (1) The number of flashes when in the Service Mode do not include the 1.5 second period when the lights light up at first (starting signal). (See the example shown below.)

- In the case of current safe (heating CT1) (example: stop code "32")
The RUN light (10's digit) flashes 3 times and the TIMER light (1's digit) flashes 2 times.
 $3 \times 10 + 2 \times 1 = 32 \rightarrow$ From the table, read the instructions for error code 32, "Current safe (heating CT1).

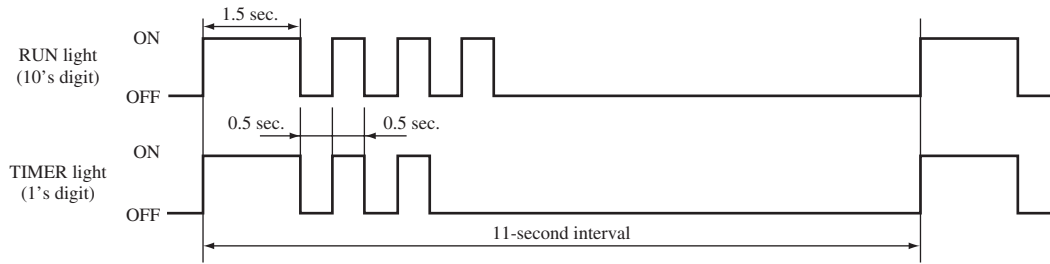

- (2) Abnormal Stop: – Is not displayed. (automatic recovery only)
 Displayed.
 If there is a () displayed, the error display shows the number of times that an automatic recovery occurred for the same reason has reached the number of times in ().
 If no () is displayed, the error display shows that the trouble has occurred once.
- (3) Automatic Recovery: – Does not occur
 Automatic recovery occurs.

(d) Remote control information tables

1) Operation switching

Display pattern when in service mode	Operation switching when there is an abnormal stop
RUN light (Operation switching)	
0	AUTO
1	DRY
2	COOL
3	FAN
4	HEAT

2) Fan speed switching

Display pattern when in service mode	Fan speed switching when there is an abnormal stop
TIMER light (Fan speed switching)	
0	AUTO
2	HI
3	MED
4	LO
6	HI POWER
7	ECONO

* If no data are recorded (error code is normal), the information display in the remote control becomes as follows.

Remote control setting	Display when error code is normal.
Operation switching	AUTO
Fan speed switching	AUTO

(Example): Operation switching, fan speed switching, cooling HI

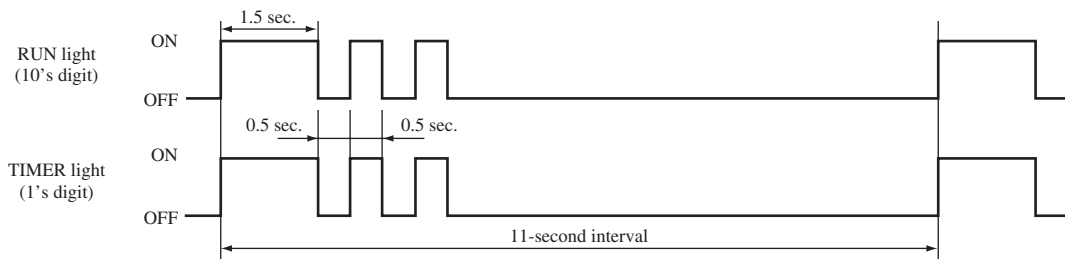

(e) Room temperature sensor temperature, indoor heat exchanger sensor temperature, outdoor air temperature sensor temperature, outdoor heat exchanger sensor temperature table

Units: °C

Buzzer sound (minus)	RUN light (10's digit)	TIMER light (1's digit)										
		0	1	2	3	4	5	6	7	8	9	
Yes (sounds for 0.1 second)	6	-60	-61	-62	-63	-64						
	5	-50	-51	-52	-53	-54	-55	-56	-57	-58	-59	
	4	-40	-41	-42	-43	-44	-45	-46	-47	-48	-49	
	3	-30	-31	-32	-33	-34	-35	-36	-37	-38	-39	
	2	-20	-21	-22	-23	-24	-25	-26	-27	-28	-29	
	1	-10	-11	-12	-13	-14	-15	-16	-17	-18	-19	
	0	/	-1	-2	-3	-4	-5	-6	-7	-8	-9	
No (does not sound)	0	0	1	2	3	4	5	6	7	8	9	
	1	10	11	12	13	14	15	16	17	18	19	
	2	20	21	22	23	24	25	26	27	28	29	
	3	30	31	32	33	34	35	36	37	38	39	
	4	40	41	42	43	44	45	46	47	48	49	
	5	50	51	52	53	54	55	56	57	58	59	
	6	60	61	62	63	64	65	66	67	68	69	
	7	70	71	72	73	74	75	76	77	78	79	
	8	80	81	82	83	84	85	86	87	88	89	
	9	90	91	92	93	94	95	96	97	98	99	

* If no data are recorded (error code is normal), the display for each sensor becomes as shown below.

Sensor name	Sensor value displayed when the error code is normal
Room temperature sensor temperature	-19°C
Indoor heat exchanger sensor temperature	-64°C
Outdoor air temperature sensor temperature	-64°C
Outdoor heat exchanger sensor temperature	-64°C

(Example) Room temperature, indoor heat exchanger, outdoor air temperature, outdoor heat exchanger: “-9°C”

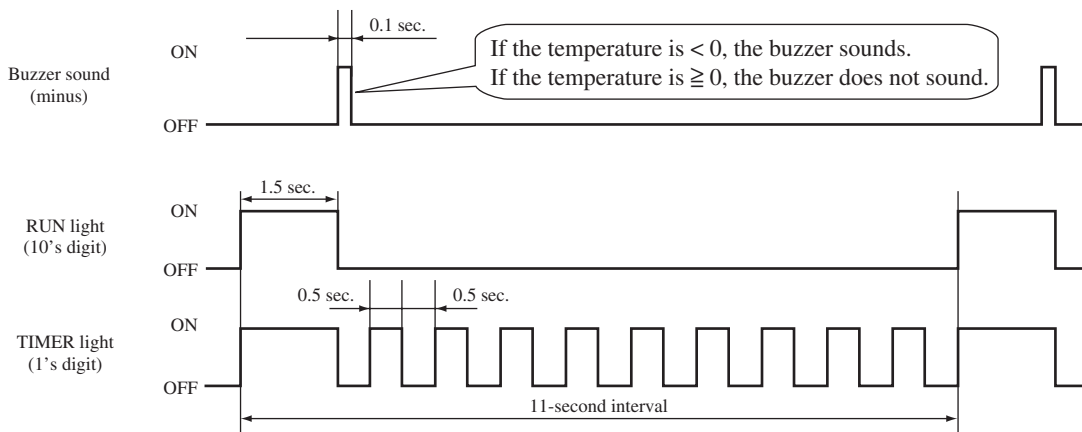

(f) Discharge pipe temperature table

Units: °C

Buzzer sound (minus)		TIMER light (1's digit)											
		0	1	2	3	4	5	6	7	8	9		
RUN light (10's digit)													
Yes (sounds for 0.1 second)	3	-60	-62	-64									
	2	-40	-42	-44	-46	-48	-50	-52	-54	-56	-58		
	1	-20	-22	-24	-26	-28	-30	-32	-34	-36	-38		
	0	/	-2	-4	-6	-8	-10	-12	-14	-16	-18		
No (does not sound)	0	0	2	4	6	8	10	12	14	16	18		
	1	20	22	24	26	28	30	32	34	36	38		
	2	40	42	44	46	48	50	52	54	56	58		
	3	60	62	64	66	68	70	72	74	76	78		
	4	80	82	84	86	88	90	92	94	96	98		
	5	100	102	104	106	108	110	112	114	116	118		
	6	120	122	124	126	128	130	132	134	136	138		
	7	140	142	144	146	148	150						

* If no data are recorded (error code is normal), the display for each sensor becomes as shown below.

Sensor name	Sensor value displayed when the error code is normal
Discharge pipe sensor temperature	-64°C

(Example) Discharge pipe temperature: “122°C”

* In the case of discharge pipe data, multiply the reading value by 2. (Below, $61 \times 2 = “122°C”$)

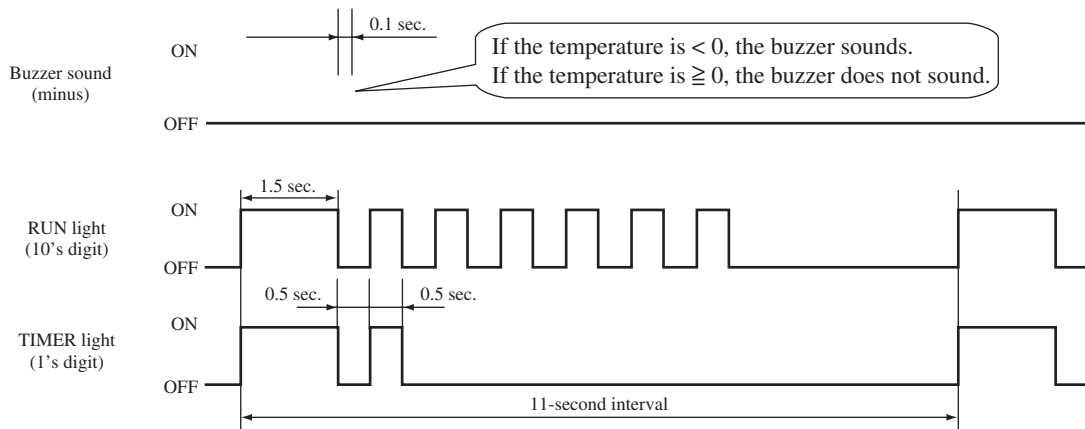

Service data record form

Customer			Model				
Date of investigation							
Machine name							
Content of complaint							
Remote control settings			Content of displayed data	Display results			Display content
Temperature setting	Operation switching	Fan speed switching		Buzzer (Yes/No.)	RUN light (Times)	TIMER light (Times)	
21	Cooling	MED	Error code on previous occasion.	/			
		HI	Room temperature sensor temperature on previous occasion.				
		AUTO	Indoor heat exchanger sensor temperature on previous occasion.				
	Heating	LO	Remote control information on previous occasion.	/			
		MED	Outdoor air temperature sensor temperature on previous occasion.				
		HI	Outdoor heat exchanger sensor temperature on previous occasion.				
22	Cooling	MED	Error code on second previous occasion.	/			
		HI	Room temperature sensor temperature on second previous occasion.				
		AUTO	Indoor heat exchanger sensor temperature on second previous occasion.				
	Heating	LO	Remote control information on second previous occasion.	/			
		MED	Outdoor air temperature sensor temperature on second previous occasion.				
		HI	Outdoor heat exchanger sensor temperature on second previous occasion.				
23	Cooling	MED	Error code on third previous occasion.	/			
		HI	Room temperature sensor temperature on third previous occasion.				
		AUTO	Indoor heat exchanger sensor temperature on third previous occasion.				
	Heating	LO	Remote control information on third previous occasion.	/			
		MED	Outdoor air temperature sensor temperature on third previous occasion.				
		HI	Outdoor heat exchanger sensor temperature on third previous occasion.				
24	Cooling	MED	Error code on fourth previous occasion.	/			
		HI	Room temperature sensor temperature on fourth previous occasion.				
		AUTO	Indoor heat exchanger sensor temperature on fourth previous occasion.				
	Heating	LO	Remote control information on fourth previous occasion.	/			
		MED	Outdoor air temperature sensor temperature on fourth previous occasion.				
		HI	Outdoor heat exchanger sensor temperature on fourth previous occasion.				
25	Cooling	MED	Error code on fifth previous occasion.	/			
		HI	Room temperature sensor temperature on fifth previous occasion.				
		AUTO	Indoor heat exchanger sensor temperature on fifth previous occasion.				
	Heating	LO	Remote control information on fifth previous occasion.	/			
		MED	Outdoor air temperature sensor temperature on fifth previous occasion.				
		HI	Outdoor heat exchanger sensor temperature on fifth previous occasion.				
21	Cooling	Lo	Stop code on previous occasion.				
22			Stop code on second previous occasion.				
23			Stop code on third previous occasion.				
24			Stop code on fourth previous occasion.				
25			Stop code on fifth previous occasion.				
26			Stop code on sixth previous occasion.				
27			Stop code on seventh previous occasion.				
28			Stop code on eighth previous occasion.				
29			Stop code on ninth previous occasion.				
30			Stop code on tenth previous occasion.				
Judgment						Examiner	
Remarks							

(7) Inspection procedures corresponding to detail of trouble

Sensor error

[Broken sensor wire, connector poor connection]

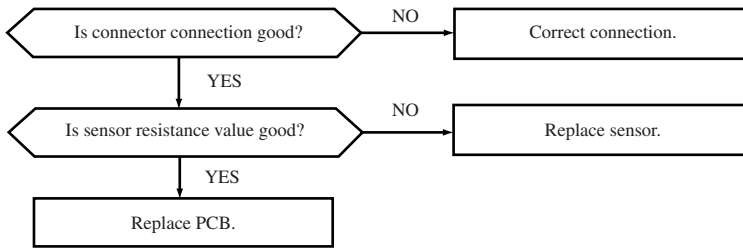

◆ Discharge pipe sensor temperature characteristics

Temperature (°C)	Resistance (kΩ)	Temperature (°C)	Resistance (kΩ)
0	164	70	8.7
5	127	75	7.3
10	99	80	6.2
15	78	85	5.3
20	62	90	4.5
25	50	95	3.9
30	40	100	3.3
35	32	105	2.9
40	26	110	2.5
45	21	115	2.2
50	17	120	1.9
55	14	125	1.6
60	12	130	1.4
65	10	135	1.3

◆ Sensor temperature characteristics (Room temp., indoor unit heat exchanger temp., outdoor unit heat exchanger temp., outdoor air temp.)

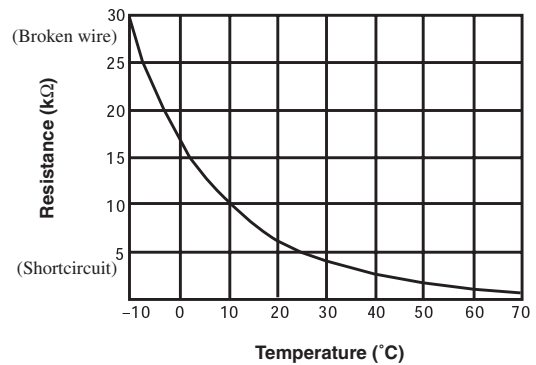

Indoor fan motor error

[Defective fan motor, connector poor connection, defective PCB]

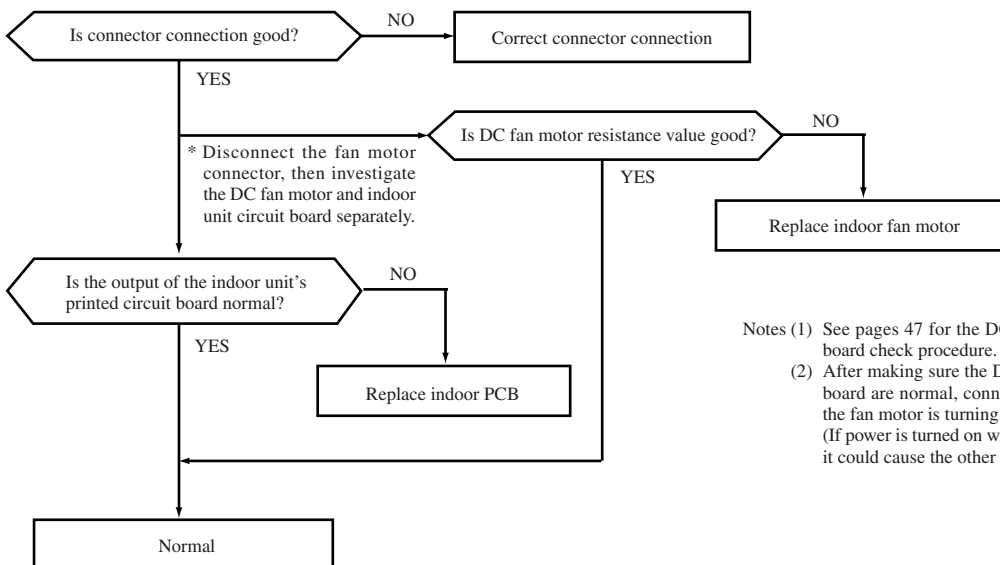

Notes (1) See pages 47 for the DC fan motor and indoor unit circuit board check procedure.
 (2) After making sure the DC fan motor and indoor unit circuit board are normal, connect the connectors and confirm that the fan motor is turning.
 (If power is turned on while one or the other is broken down, it could cause the other to break down also.)

Current cut

[Open phase on compressor output terminal, compressor lock]

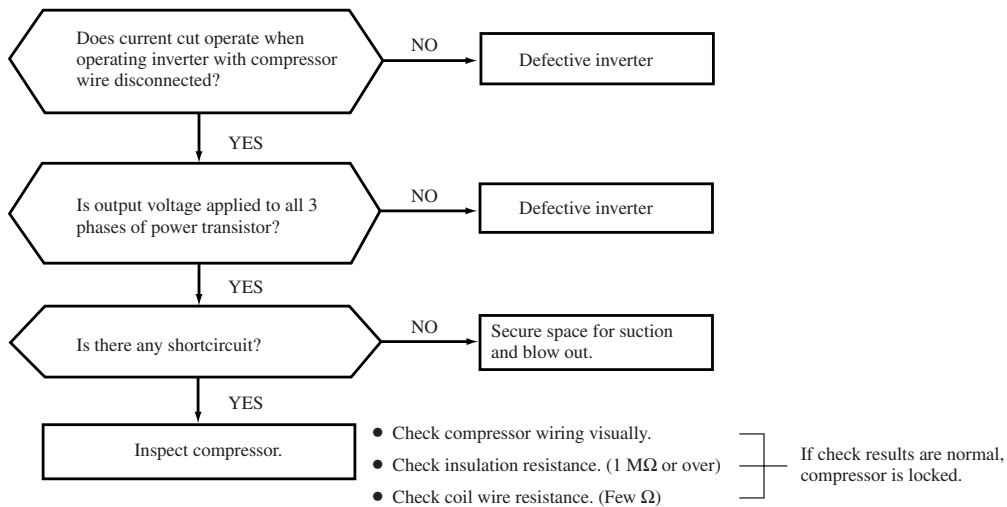

Trouble of outdoor unit

[Compressor malfunction of insufficient gas (refrigerant)]

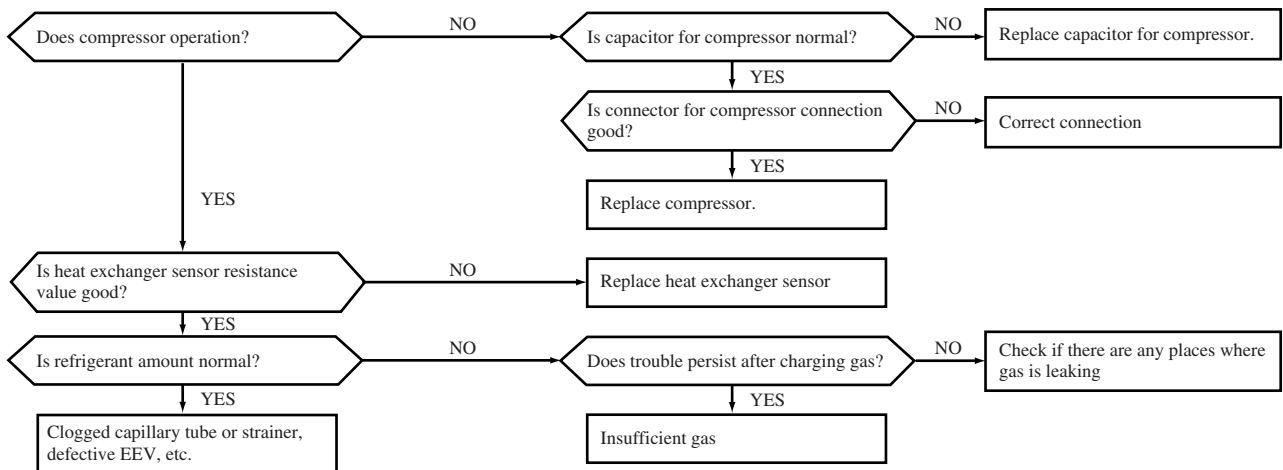

Current safe stop

[Overload operation, compressor lock, overcharge]

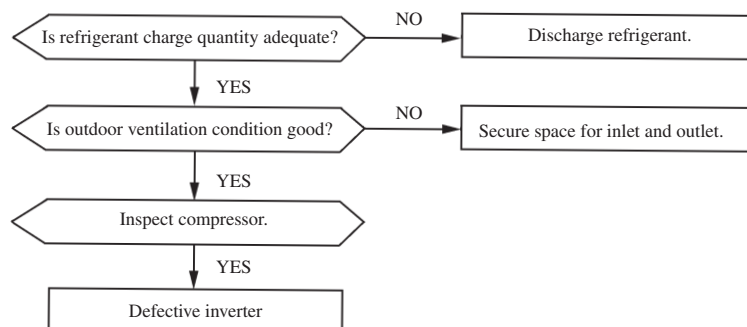

Over heat of compressor

[Gas shortage, defective discharge pipe sensor]

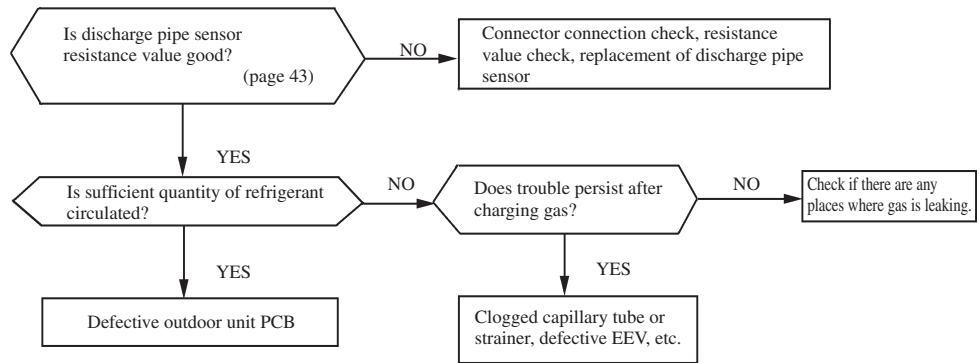

Error of signal transmission

[Wiring error including power cable, defective indoor/outdoor unit PCB]

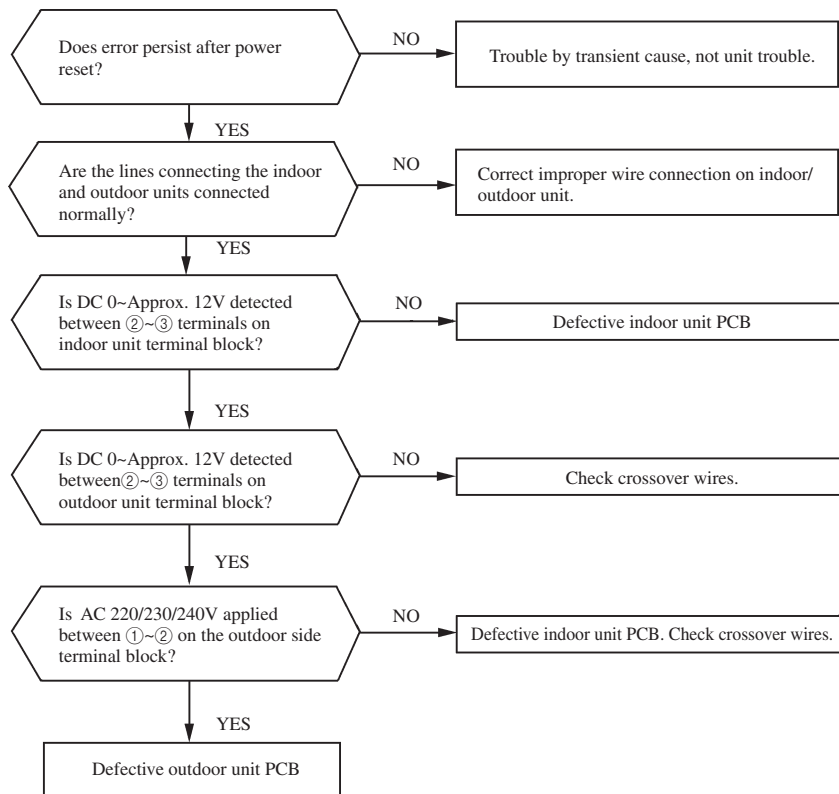

Outdoor fan motor error

[Defective fan motor, connector poor connection, defective PCB]

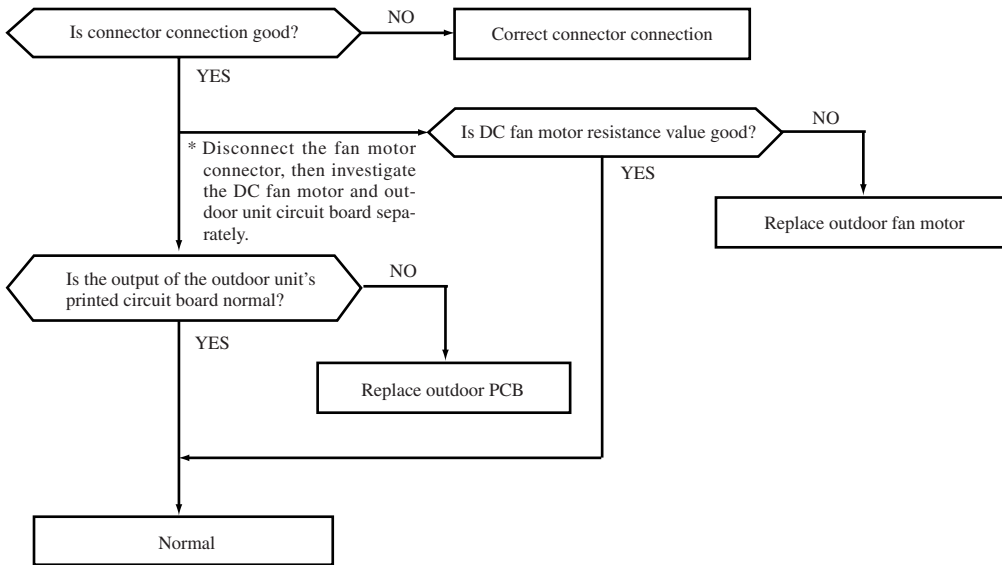

Rotor lock

[Compressor defect, outdoor unit circuit defect]

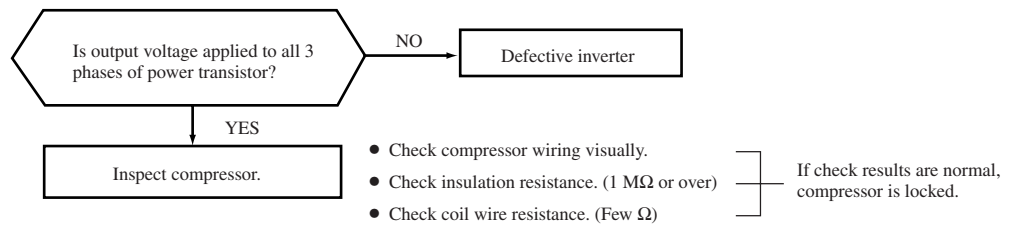

(8) Phenomenon observed after shortcircuit, wire breakage on sensor

(a) Indoor unit

Sensor	Operation mode	Phenomenon	
		Shortcircuit	Broken wire
Room temperature sensor	Cooling	Release of continuous compressor operation command	Continuous compressor operation command is not released.
	Heating	Continuous compressor operation command is not released.	Release of continuous compressor operation command
Heat exchanger sensor	Cooling	System can be operated normally.	Continuous compressor operation command is not released. (Anti-frosting)
	Heating	High pressure control mode (Inverter stop command)	Hot keep (Indoor fan stop)
Humidity Sensor	Cooling	① in the table below.	① in the table below.
	Heating	Normal system operation is possible.	

Note (1) The humidity sensor is included in the 35 and 50 type only.

① Humidity sensor operation

Failure mode	Control input circuit reading	Air conditioning system operation
Disconnected wire	① Disconnected wire	Humidity reading is 0%
	② Disconnected wire	Humidity reading is 0%
	①② Disconnected wire	Humidity reading is 0%
Short Circuit	① and ② are short circuited	Humidity reading is 100%

Remark: Do not perform a continuity check of the humidity sensor with a tester. If DC current is applied, it could damage the sensor.

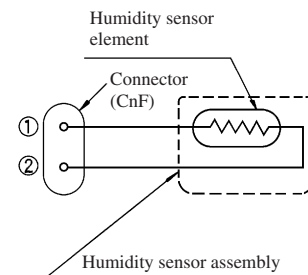

(b) Outdoor unit

Sensor	Operation mode	Phenomenon	
		Shortcircuit	Broken wire
Heat exchanger sensor	Cooling	System can be operated normally.	System can be operated normally.
	Heating	Defrosting is not performed.	Defrosting is performed for 10 minutes at approx. 45 minutes.
Outdoor air temperature sensor	Cooling	System can be operated normally.	System can be operated normally.
	Heating	Defrosting is not operated.	Defrosting is performed for 10 minutes at approx. 45 minutes.
Discharge pipe sensor	All modes	Compressor overload protection is disabled. (Can be operated.)	Compressor stop

(9) Checking the indoor electrical equipment

(a) Indoor unit circuit board check procedure

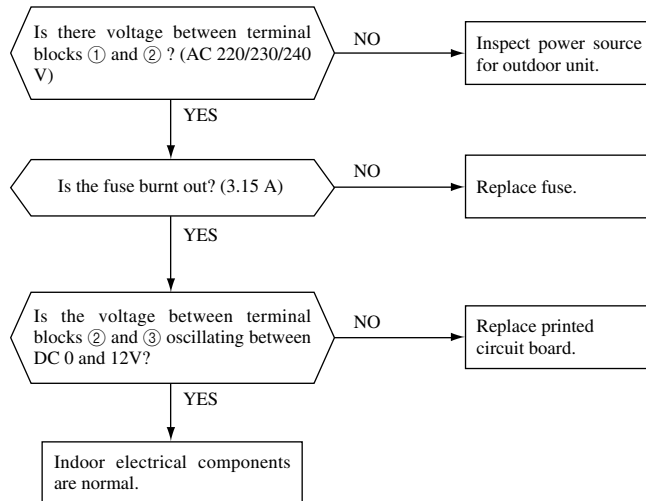

(b) Indoor unit fan motor check procedure

This is a diagnostic procedure for determining if the indoor unit's fan motor or the circuit board is broken down.

1) Indoor unit printed circuit board output check

- a) Turn off the power.
- b) Remove the front panel, then disconnect the fan motor lead wire connector.
- c) Turn on the power. If the unit operates when the ON/OFF button is pressed, if trouble is detected after the voltages in the following figure are output for approximately 30 seconds, it means that the circuit board is normal and the fan motor is broken down.

If the voltages in the following figure are not output at connector pins No. ①, ④ and ⑤, the indoor unit's circuit board has failed and the fan motor is normal.

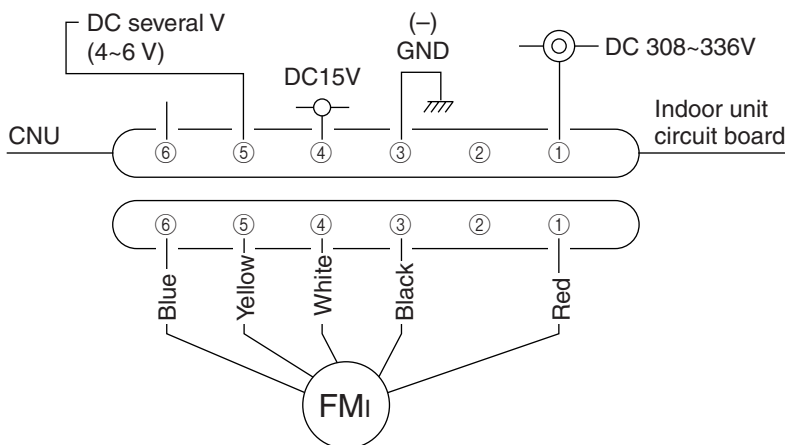

2) DC Fan motor resistance check

Measuring Point	Resistance when Normal
① - ③ (Red - Black)	25 MΩ or higher
④ - ③ (White - Black)	30 kΩ or higher

- Notes (1) Remove the fan motor and measure it without power connected to it.
 (2) If the measured value is below the value when the motor is normal, it means that the fan motor is faulty.

(10) How to make sure of remote control

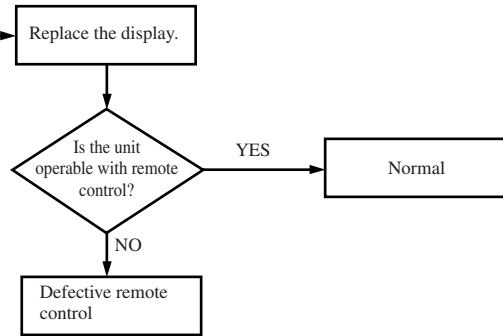
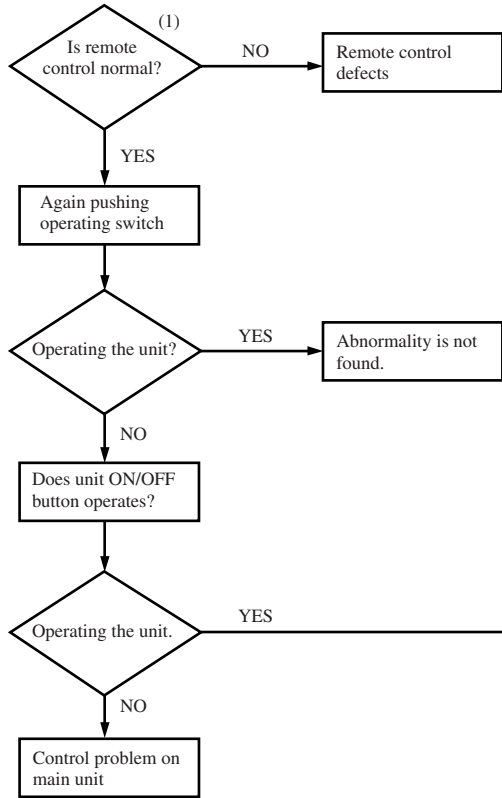

Note (1) Check method of remote control

(a) Press the reset switch of the remote control.

(b) If all LCD are displayed after one (1) display, it is basically normal.

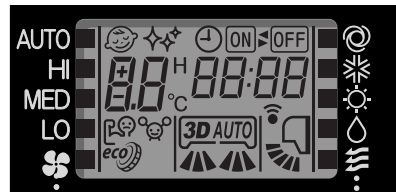

◆ Check point of outdoor unit (20, 25, 35 type)

⚠ CAUTION – HIGH VOLTAGE
 High voltage is produced in the control box. Don't touch electrical parts in the control box for 5 minutes after the unit is stopped.

Color symbol

BK	Black
RD	Red
WH	White
Y/GN	Yellow/Green

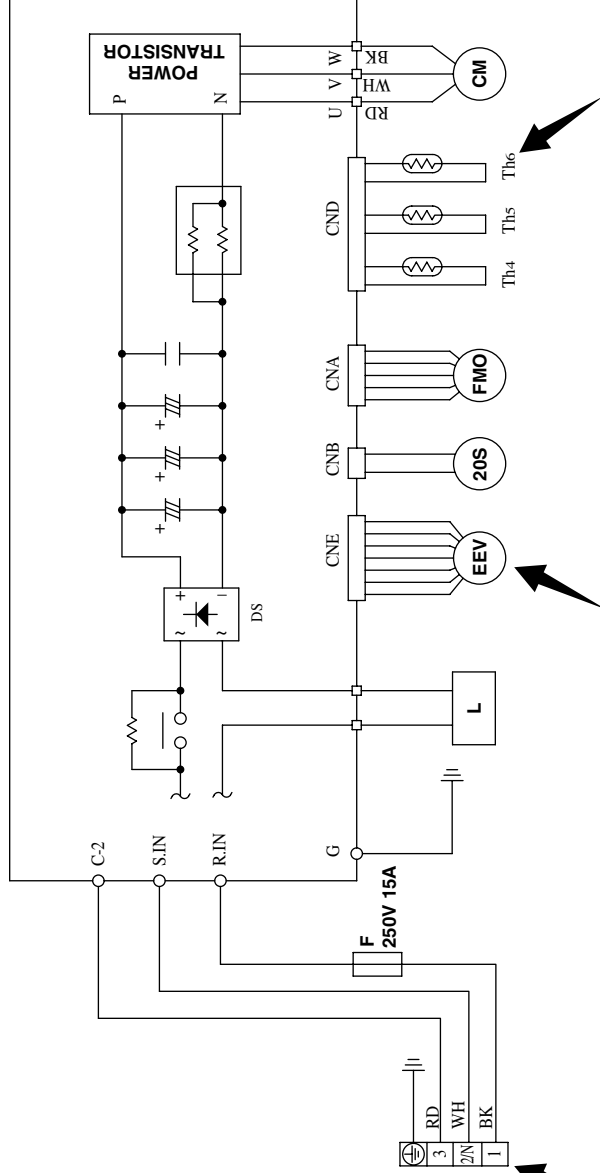

- ◆ **Inspection of input to PCB**
 - Check the voltage between terminals ①-② on the terminal block. (It is normal if AC 220/230/240V is detected.)
- ◆ **Inspection of serial signal**

Check the voltage between terminals ②-③ on the terminal block. (It is normal if the needle swing in the range of DC 0~Approx.12V)

- ◆ **Inspection of electronic expansion valve**

To test if there is voltage.
 (Voltage is only applied to the electronic expansion valve when the valve opening is being changed.)
 Red to White
 Red to Orange
 Brown to Yellow
 Brown to Blue

Normal if there is approximately DC 5 V 10 seconds after the power supply is turned on.

if the expansion valve does not operate as shown above, it is defective.

- ◆ **Inspection of resistance value of sensor**

Remove the connector and check the resistance value. See the section of sensor characteristics on page 43.

◆ Check point of outdoor unit (50 type)

CAUTION – HIGH VOLTAGE
 High voltage is produced in the control box. Don't touch electrical parts in the control box for 5 minutes after the unit is stopped.

Color symbol

BK	Black
BR	Brown
RD	Red
GR	Green
BL	Blue
OR	Orange
WH	White
Y/GN	Yellow/Green

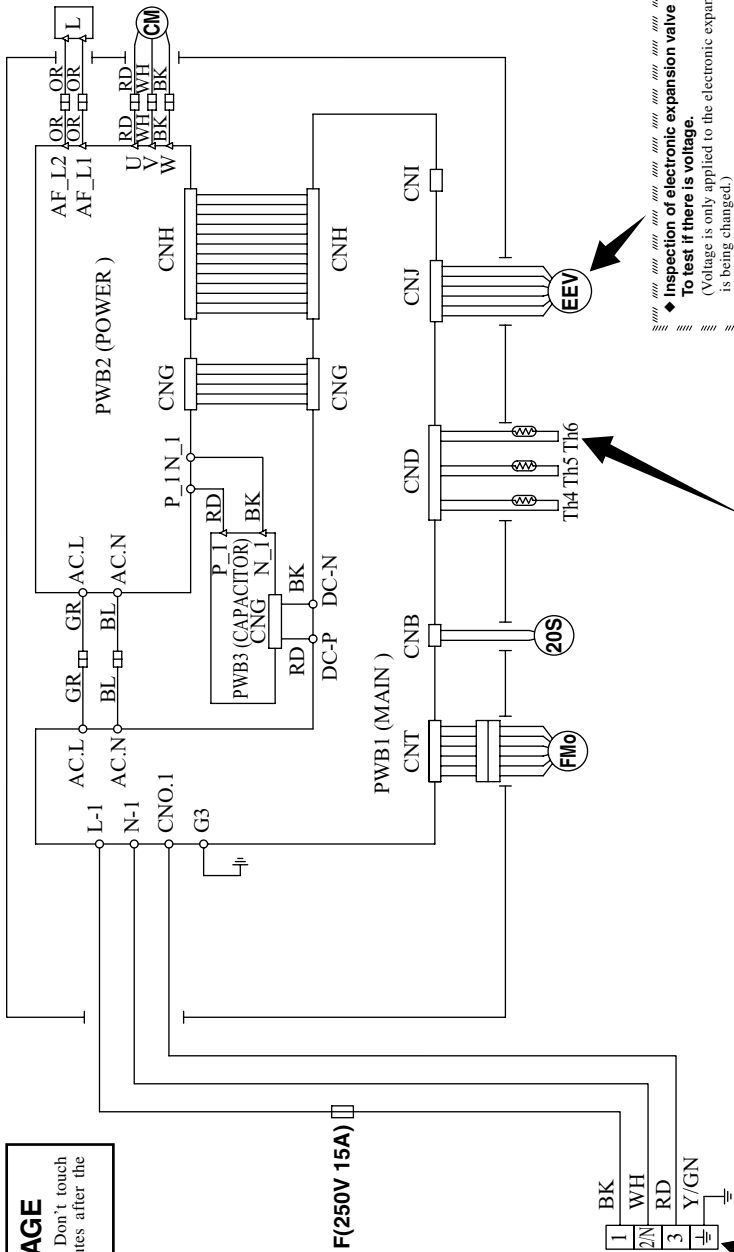

F(250V 15A)



◆ Inspection of input to PCB

- Check the voltage between terminals ①-② on the terminal block. (It is normal if AC 220/230/240V is detected.)

◆ Inspection of serial signal

- Check the voltage between terminals ②-③ on the terminal block. (It is normal if the needle swing in the range of DC 0-Approx.12V)

◆ Inspection of resistance value of sensor

Remove the connector and check the resistance value. See the section of sensor characteristics on page 43.

◆ Inspection of electronic expansion valve

To test if there is voltage. (Voltage is only applied to the electronic expansion valve when the valve opening is being changed.)

- Red to White
 - Red to Orange
 - Brown to Yellow
 - Brown to Blue
- Normal if there is approximately DC 5 V 10 seconds after the power supply is turned on.

If the expansion valve does not operate as shown above, it is defective.

◆ Power transistor inspection procedure

[Use a tester with a needle indicator for the inspection. (Do not use a digital tester. Check in the AC 300 volt range.)]

- If there is a self-diagnosis display, inspect the compressor system (burns, wiring mistakes, etc.) If no problems are found, check the output of the power transistor.
- Output inspection procedure
 Disconnect the terminals for the compressor.
 If an output such as the one shown in the figure on the right can be measured, the power transistor and the circuit board for the outdoor unit are normal.

※ For about 50 seconds. After being switched on, there will be a delay of approximately one minute depending on the conditions.

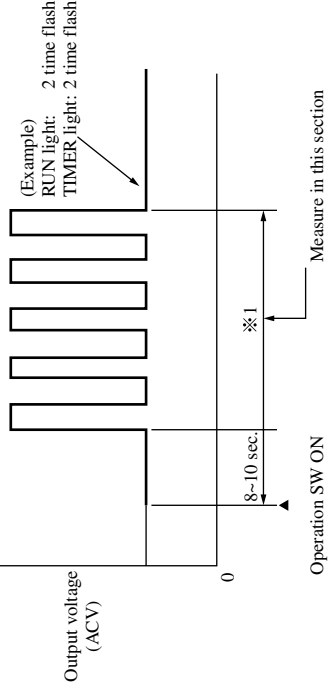

6.2 Servicing

(1) Evacuation

The evacuation is an procedure to purge impurities.....noncondensable gas, air, moisture from the refrigerant equipment by using a vacuum pump. Since the refrigerant R410A is very insoluble in water, even a small amount of moisture left in the refrigerant equipment will freeze, causing what is called water clogging.

- Evacuation procedure

- Check to ensure that there is no internal pressure in the unit. If there is an internal pressure, it should be relieved through the check joint.
- Connect the service hoses of the gauge manifold to the check joint of the gas & liquid piping.
- Connect a vacuum pump to the charge hose (A) . Repeat evacuation in the following sequence.

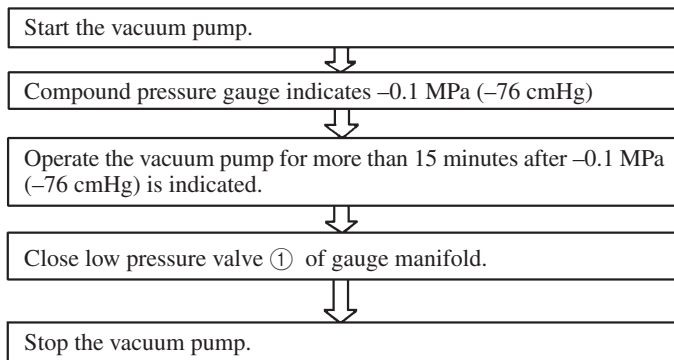

- Notes
- Do not use the refrigerant pressure to expel air.
 - Do not use the compressor for evacuation.
 - Do not operate the compressor in the vacuum condition.

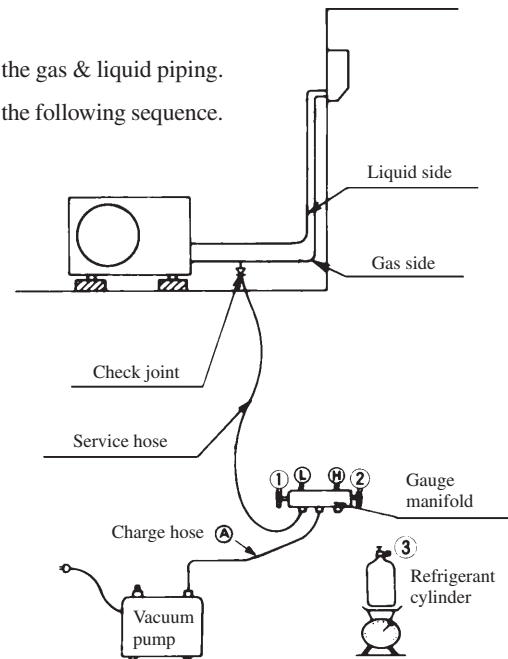

(2) Refrigerant charge

- Discharge refrigerant entirely from the unit and evacuate the unit.

Note: Addition of refrigerant without evacuation is unreasonable, because it will result in low charge or overcharge.

- Keep the gauge manifold and connect a refrigerant cylinder to the unit.
- Record the weight of the refrigerant cylinder on the balance. This is necessary for making sure of the charged refrigerant amount.
- Purge air from the charge hose (A)

Firstly loose the connecting portion of the charge hose (A) at the gauge manifold side and open the valve ③ for a few seconds, and then immediately retighten it after observing that gas is blow out from the loosened portion.
- Open the valve ① and ③ after discharging air from the charge hose (A), then the liquid refrigerant begins flowing from the cylinder into the unit. Be sure to erect the refrigerant cylinder upright to let liquid refrigerant flow into the unit.
- When refrigerant has been charged into the system to some extent, refrigerant flow becomes stagnant, when that happens, start the compressor in cooling cycle until the unit is filled with refrigerant to the specified weight.
- Making sure of the refrigerant amount, close the valve ③
- Disconnect the charge hose from the unit. Cover the valve ports of the refrigerant piping with caps and tighten them securely.
- Check for gas leakage applying a gas leak detector along the piping line.
- Start the air conditioner and make sure of its operating condition.....high side and low side pressures and temperature difference between return air and supply air.

7 INTERFACE KIT (OPTIONAL PARTS)

7.1 Applicable model

Name	Type	
Interface kit	SC-BIK-E	SRK20ZG-S, SRK25ZG-S SRK35ZG-S, SRK50ZG-S

7.2 List of connectable devices

Name	Type
Wired remote control	RC-E1R
Super link adapter	SC-AD-ER
Center console	SC-SLA1-ER, SC-SLA2A-ER, SC-SLA3-ER

7.3 Exterior dimensions

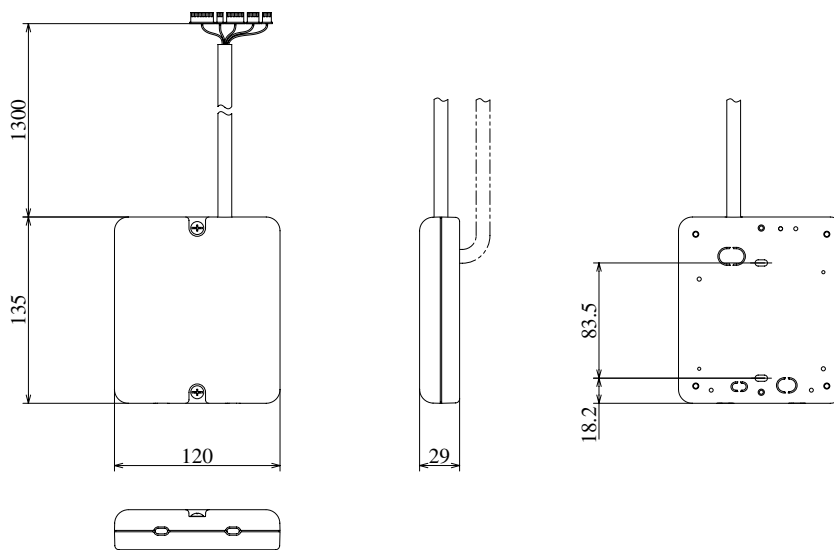

7.4 Circuit board component layout

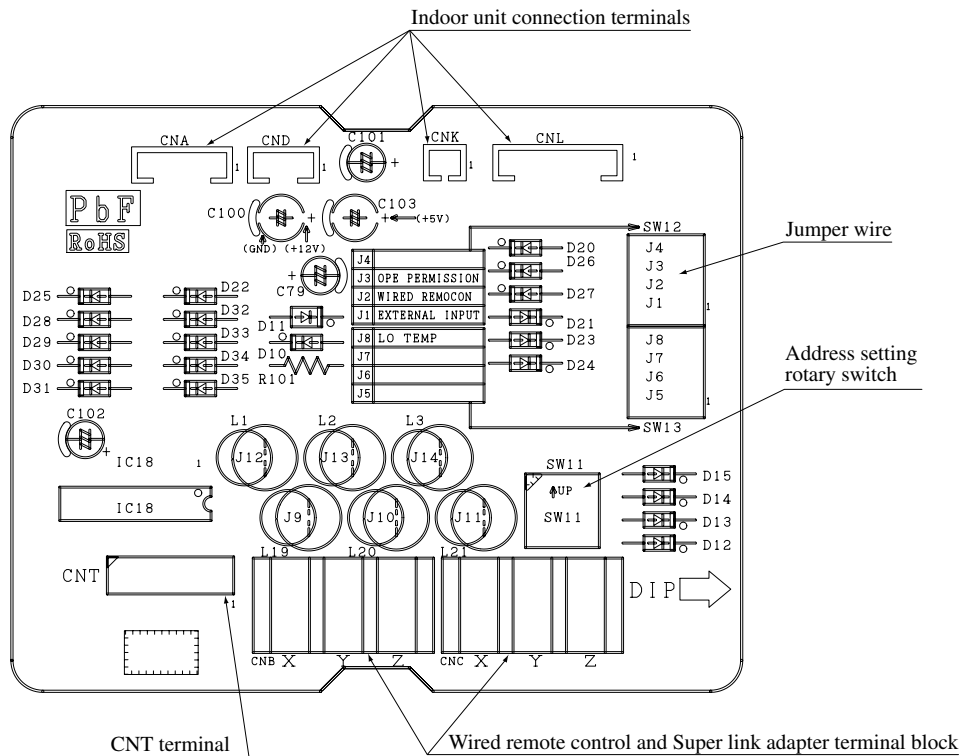

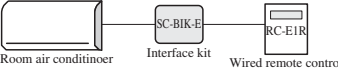
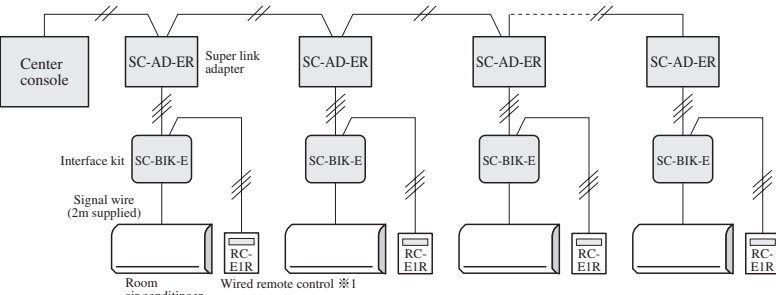
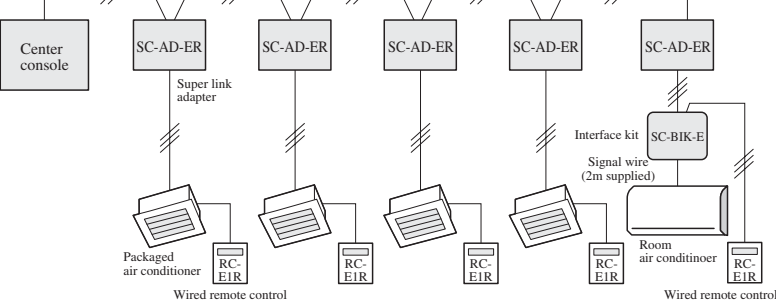
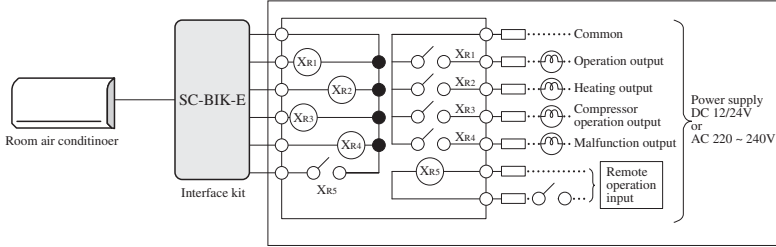
System configuration	Control contents	Use	Parts used
<p>① Wired remote control system</p> 	<p>Using the wired remote control system, users can run and stop the unit, switch operations, adjust the temperature, fan speed and air flow direction (up or down), and control timer operation .</p>	<p>Use a wired remote control for retirement homes, school classrooms and similar locations.</p>	<ul style="list-style-type: none"> • Wired remote control (RC-E1R) • Interface kit (SC-BIK-E)
<p>② Control of multiple units with a remote control</p> 	<p>Multiple units (16units~144units) can be controlled with a single remote control.</p>	<p>For hotels and similar facilities with multiple units installed, the remote control is used to turn multiple air conditioning units ON or OFF.</p>	<ul style="list-style-type: none"> • Interface kit (SC-BIK-E) • Super link adapter (SC-AD-ER) • Center console (SC-SLA1-ER, SC-SLA2A-ER, SC-SLA3-ER) • Wired remote control (RC-E1R)
	<p>Multiple units (16units~144units) can be controlled with a single remote control.</p>	<p>For users who want to exercise central control together with a package air conditioning system, such as an office.</p>	<p>※1 The wireless remote control supplied with one unit cannot be used. If it is necessary to control each room separately, use the wired remote control.</p>
<p>③ Remote operation</p> 	<ul style="list-style-type: none"> • Using the remote start/stop switch timer, etc., the unit can be started and stopped by inputting level or by inputting pulses. • The run signal, heating signal, compressor ON signal and check signal can be received by non-voltage contacts. 	<p>Remote start and stop and remote monitoring.</p>	<ul style="list-style-type: none"> • Interface kit (SC-BIK-E) • Remote ON/OFF monitor kit (Customer arrangements)

7.6 Installation of interface kit

Accessories included in package

Please check to make sure all the accessories have been included.

Part name	Quantity
Indoor unit connection cable (total cable length: 2 m)	1
Wood screws (for mounting the interface: $\phi 4 \times 25$)	2
Tapping screws (for mounting the clamp and interface mounting bracket)	3
Interface mounting bracket	1
Clamp (for the indoor unit)	1

Connecting the interface and indoor unit

- ① Remove the air inlet panel, lid and front panel.
- ② Take the indoor control board out of the control box.
- ③ There are five terminals (respectively marked with CNA, CND, CNI, CNK, and CNL) for the indoor control board. In connecting an interface, connect to the respective terminals securely with the connection harness supplied with an optional "Interface connection kit SC-BIK-E".

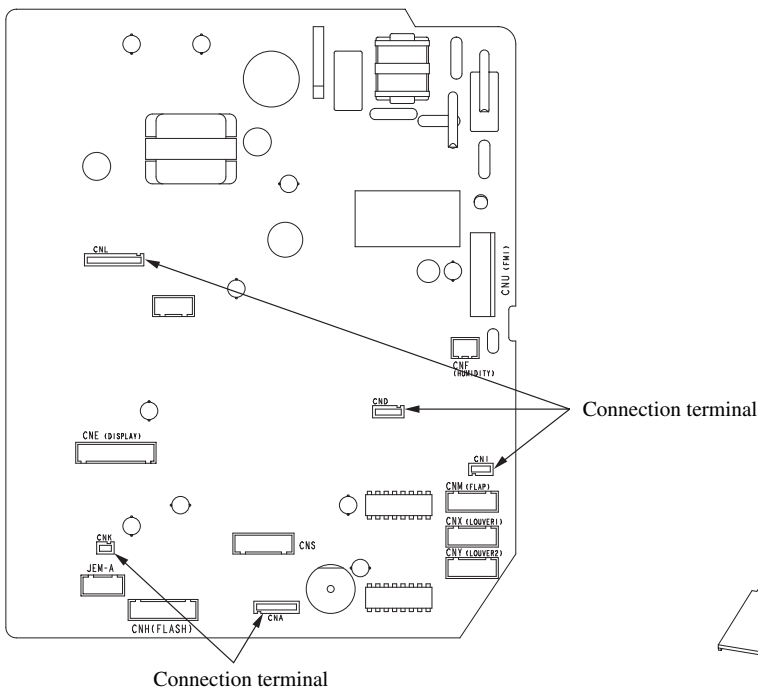
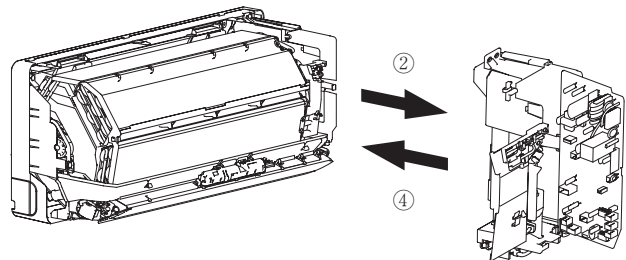

- ④ House the indoor unit control board in the control box.
- ⑤ Fasten the connection harness onto the indoor control box with clamp supplied with the kit.
- ⑥ Reinstall the front panel, lid and air inlet panel.

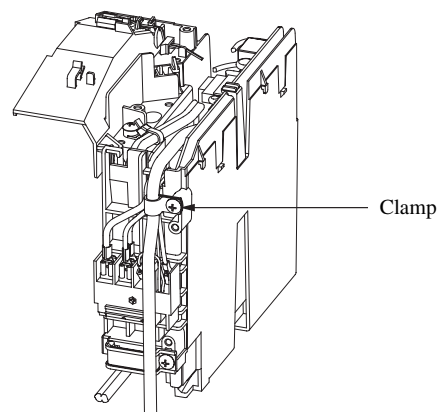

Connecting the interface and the indoor unit

- ⑦ Remove the upper case of the interface.
 - Take out the 2 screws in the interface case.
- ⑧ Install the indoor unit's connection cables in the interface.
 - Connect the connectors of the indoor unit connection cables to the connectors on the interface's circuit board. (4 places)
- ⑨ Fasten the indoor unit connection cables using clamps.
 - Cables can be brought in from the top or from the back.
 - Use side cutters, etc. to cut out the thin knockouts used to run wires into the case.

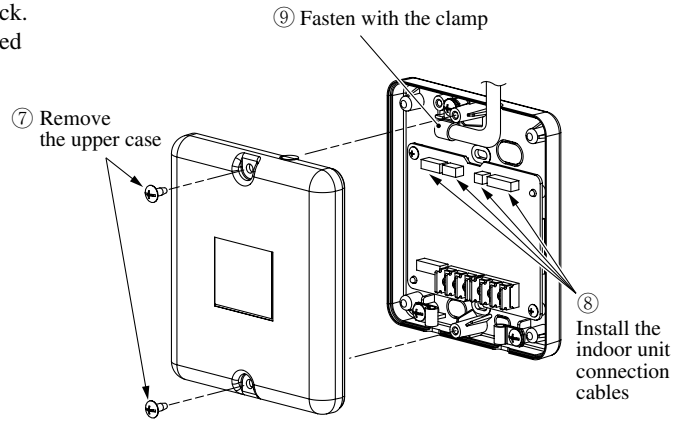

Names of each part of the interface unit

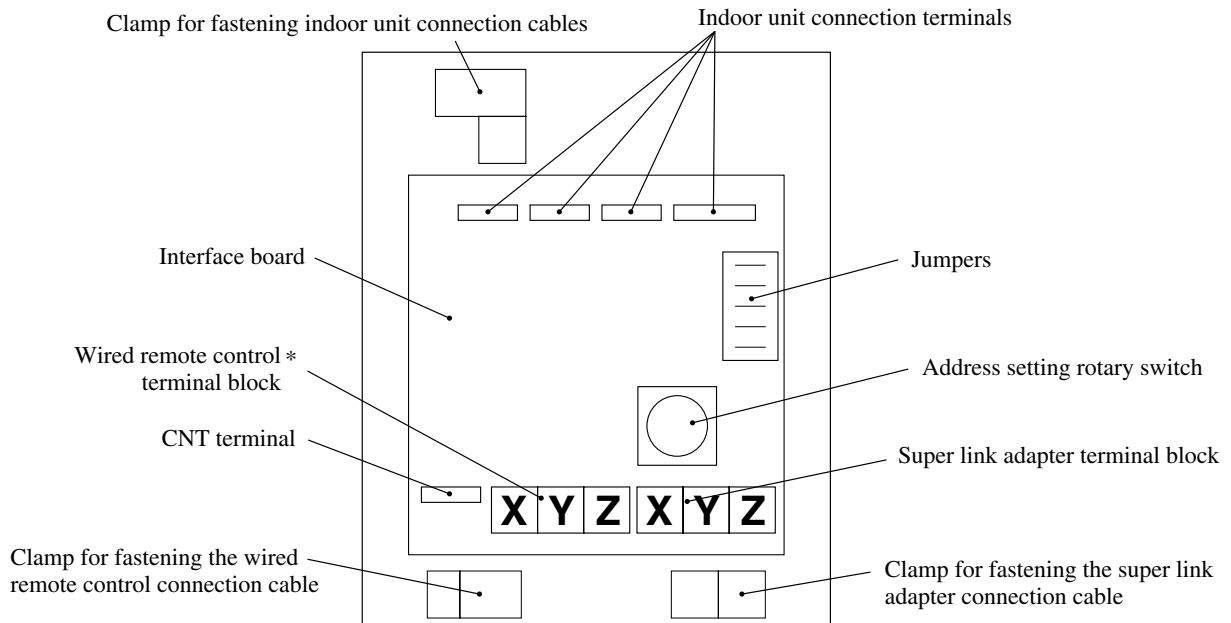

* Either the super link adapter cable or the wired remote control connection cable can be connected.

Wired remote control connection

Please see the instructions in the wired remote control's manual concerning connections to the wired remote control.

① Cut jumper wire "J2" on the circuit board.

Caution: Both the wired remote control and the wireless remote control supplied with the indoor unit cannot be used together.

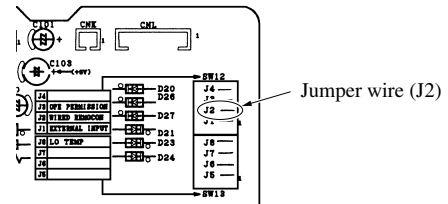

② Connect the interface and remote control.

The terminals have polarity, so be sure to connect the wires to the corresponding terminal on each end.

Be sure to strip off the only the proper length of sheath material from each connection cable in the interface unit.

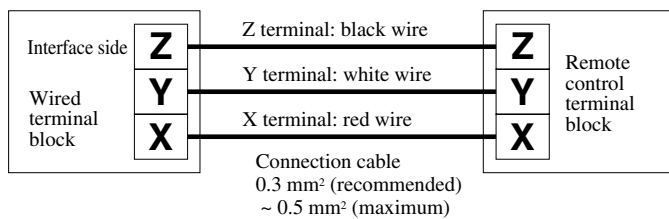

Strip off the sheath material from the connection cable wires inside the wired remote control case.

The length of wire with the sheathing removed should be as shown below for each wire.

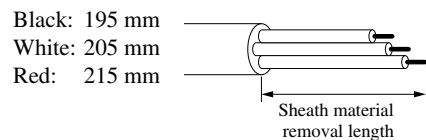

Cautions when extending the connection cable length

- The maximum total length should be 600 m.
- Be sure to use shielded cable. (Type: 0.3 mm² × 3 cores)
- If the extended length exceeds 100m, change the wire size to the following sizes. However, inside the remote control case, the maximum wire size should be 0.5 mm² or less. Change the wire size in accordance with the wires connected near the outside.
 - Within 100 ~ 200 m 0.5 mm² × 3 cores
 - Within 300 m 0.75 mm² × 3 cores
 - Within 400 m 1.25 mm² × 3 cores
 - Within 600 m 2.0 mm² × 3 cores

③ Fasten the connection cables with clamps.

● Control of multiple units with a remote control

Multiple units (up to 16 units) can be controlled with a single remote control.

① For group control, install connection cables between the unit and package air conditioner indoor units.

- Connect the cables to terminals X, Y and Z in the interface unit. Each terminal has polarity, so be sure to connect wires to the corresponding terminals at each end.
- Use cables with a size of 0.5 mm² or larger. (cables that are large enough to endure the routing required)
- Keep the total length of connection cables and remote control wiring to within 600 m.

② Set the address in each unit.

Set the address of using the rotary switch on the circuit board inside each unit. ("0" ~ "F")
Set the addresses in each group so that there is no overlapping of addresses.
After turning on the power, the indoor unit's address is displayed when the Air Conditioner No. button on the remote control is pressed, so check if the indoor unit addresses is displayed in the remote control's display when the ▲ and ▼ buttons are pressed to select each unit.

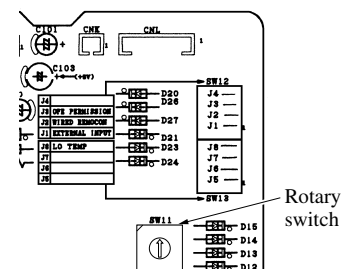

Super link adapter connection

See the super link adapter's manual concerning connections to the super link adapter.

① Cut jumper wire (J2) on the circuit board.

Caution: This device cannot be used together with the wireless remote control which is supplied with the indoor unit.

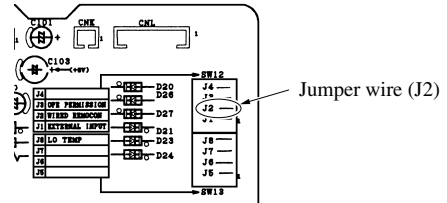

② Connections between the interface and super link adapter

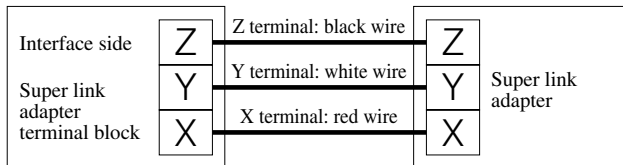

No.	Names of recommended signal wires
1	Shielded wire
2	Vinyl cabtyre round cord
3	Vinyl cabtyre round cable
4	Vinyl insulated wire/vinyl sheathed cable for control

Within 200 m 0.5 mm² × 3 cores
 Within 300 m 0.75 mm² × 3 cores
 Within 400 m 1.25 mm² × 3 cores
 Within 600 m 2.0 mm² × 3 cores

③ Fasten the super link adapter cable with clamps.

CNT connector functions

Turning the contacts ON/OFF, the off/running status of the air conditioner can be monitored from the External control unit (remote display).

- Connect a locally procured remote control unit to the CNT terminal.
- In case of the pulse input, cut off the jumper wire "J1" on the main unit PCB.
- When setting at Operation permission/prohibition Mode, cut off the jumper wire "J3".

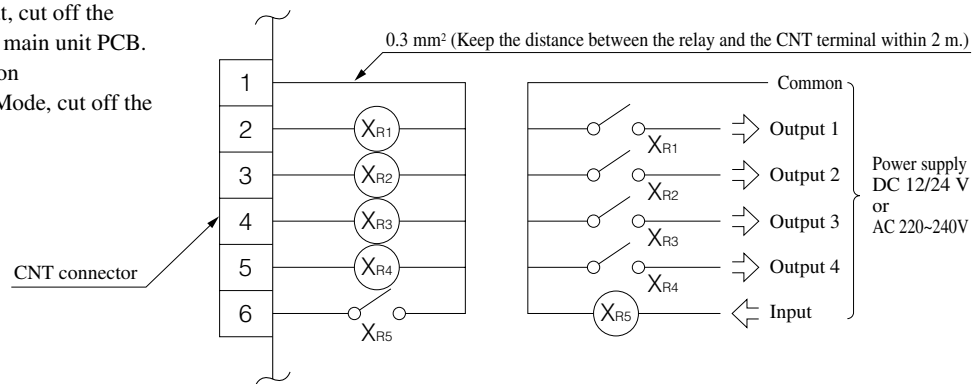

- XR1~4 are for the DC 12V relay
- XR5 is a DC 12/24 or AC 220~240V relay
- CNT connector (local) maker, model

Connector	Molex	5264-06
Terminals	Molex	5263T

Input/Output	Content
Output 1	Operation output ON output (XR1 = ON) during air conditioner operation
Output 2	Heating output ON output (XR2 = ON) during heating operation
Output 3	Compressor operation output ON output (XR3 = ON) during compressor operation
Output 4	Malfunction output ON output (XR4 = ON) during an abnormal stop
Input	Level input (At shipment) External control XR5 OFF ⇒ ON Air conditioner ON XR5 ON ⇒ OFF Air conditioner OFF
	Level input (At shipment) Operation permission/prohibition (J3 cut) XR5 OFF ⇒ ON Air conditioner OFF XR5 ON ⇒ OFF Air conditioner OFF
	Pulse input (J1 cut) External control (At shipment) XR5 Air conditioner ON/OFF is inverted depending on the pulse signal at OFF ⇒ ON.
	Pulse input (J1 cut) Operation permission/prohibition (J3 cut) XR5 Air conditioner ON/OFF is inverted depending on the pulse signal at OFF ⇒ ON.

In the operation permitted/prohibited mode, remote control operations are allowed only when the input is turned ON.

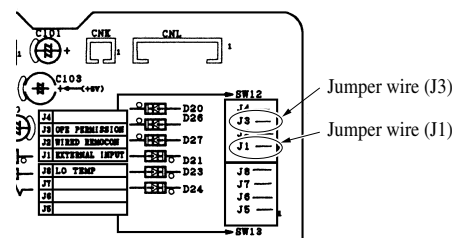

Interface installation

Install the interface so that the connection cable can reach the indoor unit (approximately 1.3 m).

If the connection cable is extended, operation will be faulty, so do not extend the cable.

Fasten the unit to a wall, pillar or similar location.

Use a side cutter or similar tool to open the thin knockouts in the case for running wires.

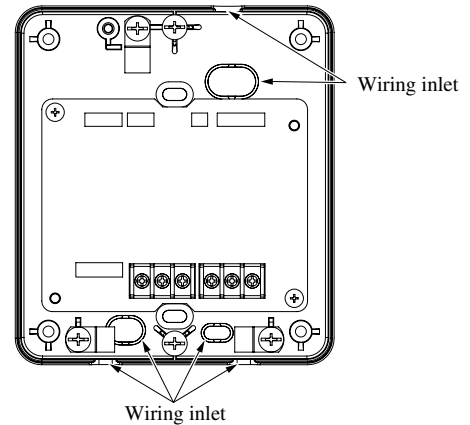

If the unit is mounted directly to a wall

- ① Mount the lower case of the interface unit to a flat surface using the wood screws supplied with the unit.
- ② Mount the upper case.

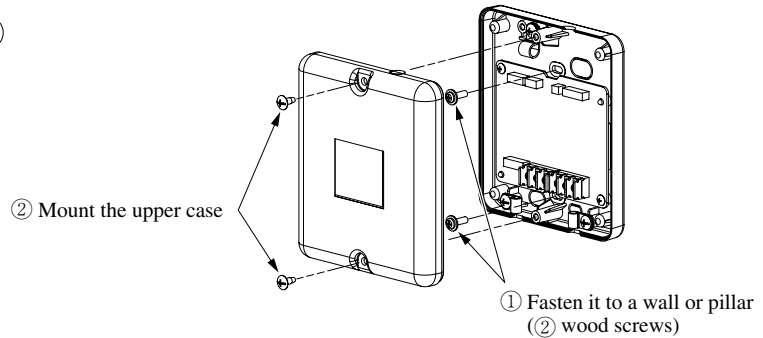

Recessing the unit in a wall

- ① Recess the electrical box (procured locally) and each connection cable inside the wall.
- ② Fasten the lower case of the interface unit to the electrical box using screws (M4 screws, procured locally).
- ③ Mount the upper case to the lower case.

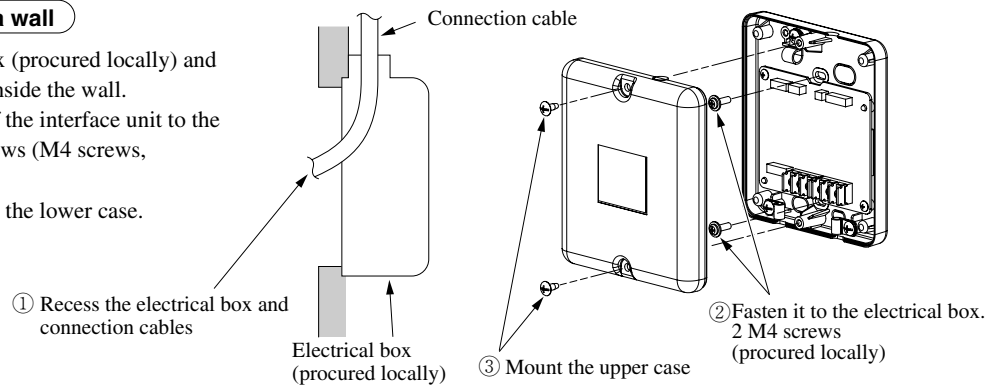

Mounting with the mounting bracket

- ① Mount the interface unit's upper case.
- ② Mount the mounting bracket to the interface unit using the tapping screws supplied with the unit.
- ③ Mount the mounting bracket to a wall surface, etc. using the wood screws provided.

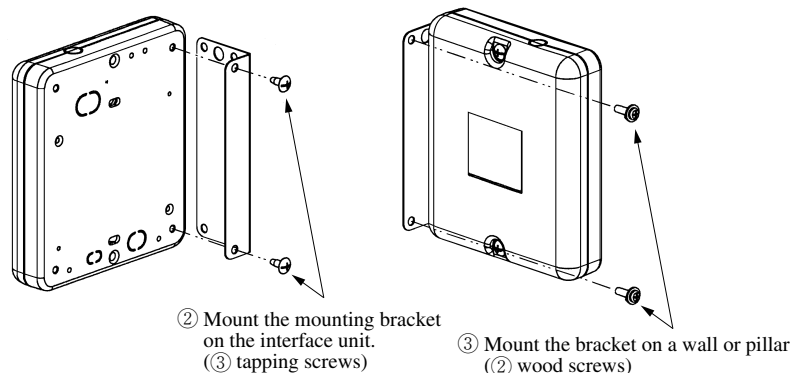

7.7 Wired remote control (Optional parts)

The figure below shows the remote control with the cover opened. Note that all the items that may be displayed in the liquid crystal display area are shown in the figure for the sake of explanation.

Characters displayed with dots in the liquid crystal display area are abbreviated.

Note (1) The SRK models don't support the switches and functions displayed in [].

Pull the cover downward to open it.

Central control display

Displayed when the air conditioning system is controlled by the option controller.

Timer operation display

Displays the settings related to timer operation.

Temperature setting switches

These switches are used to set the temperature of the room.

TIMER switch

This switch is used to select a timer mode.
(The comfortable timer or sleep operation cannot be selected.)

Timer setting switches

These switches are used to set the timer mode and time.

[GRILL switch]

Cannot be used.

AIR CON No. (Air conditioning system No.) switch

Displays the number of the connected air conditioning system.
("00" appears.)

[CHECK switch]

Cannot be used.

[TEST switch]

Cannot be used.

[Vent Indicator]

Cannot be used.

Weekly timer display

Displays the settings of the weekly timer.

Operation setting display area

Displays setting temperature, airflow volume, operation mode and operation message.

Operation/Check indicator light

During operation: Lit in green
In case of error: Flashing in red

Operation/Stop switch

This switch is used to operate and stop the air conditioning system. Press the switch once to operate the system and press it once again to stop the system.

MODE switch

This switch is used to switch between operation modes.
(The clean operation or allergen clear operation cannot be selected.)

FAN SPEED switch

This switch is used to set the airflow volume.
(AUTO, HI POWER or ECONO cannot be selected.)

[VENT switch]

Cannot be used.

LOUVER switch

This switch is used to operate/stop the swing louver.
(Up/down swing only)

SET switch

This switch is used to apply the timer operation setting.
This switch is also used to make silent mode operation settings.

[RESET switch]

Cannot be used.

* If you press any of the switches above and "INVALID OPER" is display, the switch has no function. But it does not mean a failure.

7.8 Installation of wired remote control (Optional parts)

(1) Selection of installation location

Avoid the following locations

- Direct sunlight.
- Close to heating device.
- Highly humid or water splashing area.
- Uneven surface.

(2) Installation procedure

(a) Exposed fitting

- Open the remote control cover and unscrew the screw located beneath the switch.

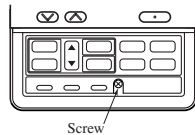

- Open the remote control case.

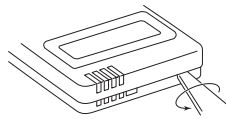

- Put a screw driver (flat-head) into the concavity made on the upper part of a remote control and twist it lightly to open the casing.
- The cord of a remote control can only be pulled out in the upward direction.

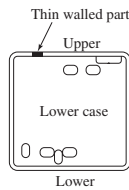

- Cut off with nippers or a knife a thin-walled part made on the upper end of the remote control bottom casing, and then remove burrs with a file or the like.
- Fix the remote control bottom casing onto a wall with two wood screws supplied as accessories.

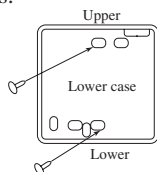

- Connect the remote control to the terminal block. Connect the terminals of the remote control to the indoor unit with the same numbers. Because the terminal block has polarity, the device becomes inoperative if there are wrong connections.

Terminals: (X) Red wire, (Y) White wire, (Z) Black wire

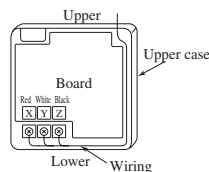

- Use a cord of 0.3mm² (recommended) - 0.5mm² (maximum) for a remote control cord. Remove a sheath of the remote control cord for the section laid within the remote control casing.

The length of each wire that should be left after a sheath is removed is as follows:

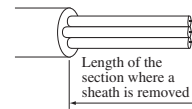

Black: 195mm, White: 205mm, Red: 125mm

- Replace the top casing as before.
- Use a cord clamp to attach the remote control cord to the wall.
- Set the functions according to the types of indoor unit. (Refer to 61 page).

(b) Recessed fitting

- The Electrical box and remote control (shield wire must be use in case of extension) are first embedded.

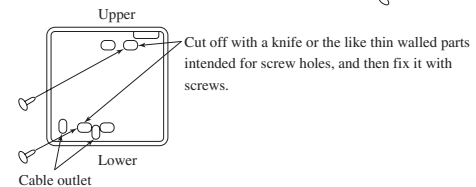
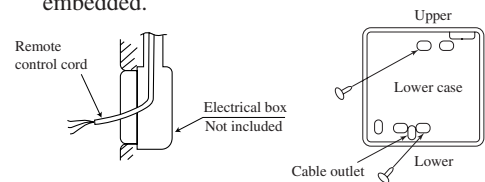

- Remove the upper case to the remote control.
- Attach the lower case to the Electrical box with two M4 screws. (Head diameter must be 8 mm). Choose either of the following two positions in fixing it with screws.
- Connect the remote control cord to the remote control. Refer to [Exposed fitting].
- Installation work is completed by replacing the top casing onto the bottom casing as before.
- Set the function switch according to the type of the indoor unit. (Refer to 61 page)

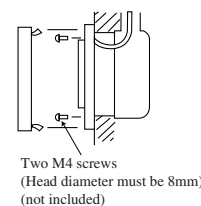

Precaution in Extending the Remote control cord

- Maximum total extension 600m.

The cord should be a shielded wire.

- For all types : 0.3mm² × 3 cores

Note (1) Use cables up to 0.5mm² (maximum) for those laid inside the remote control unit casing and connect to a different size cable at a vicinity point outside the remote control unit, if necessary.

Within 100-200m.....	0.55 mm ² × 3 cores
Within 300m.....	0.75 mm ² × 3 cores
Within 400m.....	1.25 mm ² × 3 cores
Within 600m.....	2.05 mm ² × 3 cores

- The shielded wire should be grounded at one side only.

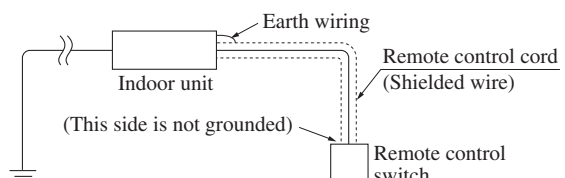























7.9 Setting functions using the wired remote control



- (1) The default settings of this unit's functions are as follows: If you want to change a setting, follow the procedure found in the installation manual and set to your desired setting.

For the method of setting, please refer to the installation manual of a remote control unit.

① Remote control unit functions ( FUNCTION ▼)

② Indoor unit functions (I/U FUNCTION ▲)

Function number (A)	Function description (B)	Setting (C)	Default setting
【01】	GRILLE ↑↓ SET (Grille lift panel setting)	↑↓ INVALID	○
		50Hz AREA ONLY	
		60Hz AREA ONLY	
02	AUTO RUN SET	AUTO RUN ON AUTO RUN OFF	○
03	 TEMP S/W	 VALID	○
		 INVALID	
04	 MODE S/W	 VALID	○
		 INVALID	
05	 ON/OFF S/W	 VALID	○
		 INVALID	
06	 FANSPEED S/W	 VALID	○
		 INVALID	
07	 LOUVER S/W	 VALID	○
		 INVALID	
08	 TIMER S/W	 VALID	○
		 INVALID	
【09】	 SENSOR S/W (Remote control sensor setting)	 SENSOR OFF (Invalid)	○
		 SENSOR ON (Valid)	
10	POWER FAILURE COMPENSATION SET	INVALID	○
		VALID	*
【11】	VENTI SET	NO VENTI	○
		VENTI LINK SET	
		NO VENTI LINK	○
12	TEMP RANGE SET	DISP CHANGE	○
		NO DISP CHANGE	
13	I/U FAN SPEED (Indoor unit fan speed setting)	3 FAN SPEED	○
		2 FAN SPEED	
		1 FAN SPEED	
14	MODEL TYPE	HEAT PUMP	○
		COOLING ONLY	
15	EXTERNAL CONTROL SET	INDIVIDUAL OPERATION	○
		SAME OPERATION FOR ALL UNITS	
16	ERROR DISP SET	ERROR DISP	○
		NO ERROR DISP	
17	 POSITION (Louver control setting)	FIX (1 OF 4) (4 position stop)	○
		IN MOTION (Free stop)	
【18】	°C/°F SET	°C	○
		°F	

Function number (A)	Function description (B)	Setting (C)	Default setting
【01】	Hi CEILING SET	STANDARD (Mild mode)	*
		Hi CEILING 1 (Powerful mode)	
【03】	FILTER SIGN SET	NO DISPLAY	*
		AFTER 180H	
		AFTER 600H	
		AFTER 1000H	
04	 POSITION (Louver control setting)	FIX (1 OF 4) (4 position stop)	○
		IN MOTION (Free stop)	
05	EXTERNAL INPUT SET	LEVEL INPUT	○
		PULSE INPUT	
06	OPERATION PERMISSION PROHIBITED	NORMAL OPERATION	○
		VALID	
【07】	 ROOM TEMP OFFSET (Heating room temperature offset)	NORMAL OPERATION	○
		TEMP SHIFT +3°C	
【08】	 FAN CONTROL (Heating fan control)	LOW FAN	*
		STOP→LOW FAN (Intermittent operation)	
【09】	FREEZE PREVENT TEMP	TEMP Hi	○
		TEMP Lo	
【10】	FREEZE PREVENT CONTROL	FAN CONTROL ON	○
		FAN CONTROL OFF	

Notes(1) Setting marked with [○] are the default setting.

(2) Setting marked with [*] are those that are set automatically according to an indoor unit or an outdoor unit connected.



Please check default settings with the indoor unit's installation manual.

(3) The SRK model cannot set the items described in [] in the function number (A).

Notes(1) Setting marked with [○] are the default setting.

(2) Setting marked with [*] are those that are set automatically according to an indoor unit or an outdoor unit connected.

Please check default settings with the indoor unit's installation manual.

(3) When Item 17 : “ POSITION” is changed, please also change Item 04 “ POSITION” setting found in “Indoor unit functions”.

(4) The SRK model cannot set the items described in [] in the function number (A).

(2) Function setting method

- (a) Stop the air conditioner
 (b) Press the SET and MODE buttons simultaneously for 3 seconds or longer.

The screen display will be switched as follows:

“SELECT ITEM” →

“SET” →

“FUNCTION SET ▼”



- (c) Press the SET button.

The unit will enter the function setting mode. The screen display will change to “FUNCTION ▼”.

- (d) Check which category your desired setting belongs to, “FUNCTION ▼ (Remote control unit function)” or “I/U FUNCTION ▲” (Indoor unit function).

- (e) Press either ▲ or ▼ button.

Select either “FUNCTION ▼” or “I/U FUNCTION ▲”.



- (f) Press the SET button.

When “FUNCTION ▼” is selected.

- ① “DATA LOADING” (blinking) → “FUNCTION” →

“01 GRILLE ↑↓ SET” (Function number: A, Function description: B)

The screen display will be switched like this.

- ② Press either ▲ or ▼ button.

“Function number: A, Function description: B” from the list of remote control unit functions will be displayed one by one. Select a desired function.

- ③ Press the SET button.

The screen display will be switched as follows:

“SETTING” → “Setting: C” (ex. “AUTO RUN ON”)

- ④ Press either ▲ or ▼ button.

A list of “Settings: C” will be displayed one by one. Select your desired setting.

- ⑤ Press the SET button.

The selected setting is displayed for 2 seconds, then followed by “SET COMPLETE” and the function setting process is completed.

Then the screen display will be switched to “Function number: A, Function description: B,” so if you want to continue to set another function, repeat the steps as explained above.

To finish the function setting process, please proceed to Step (g).

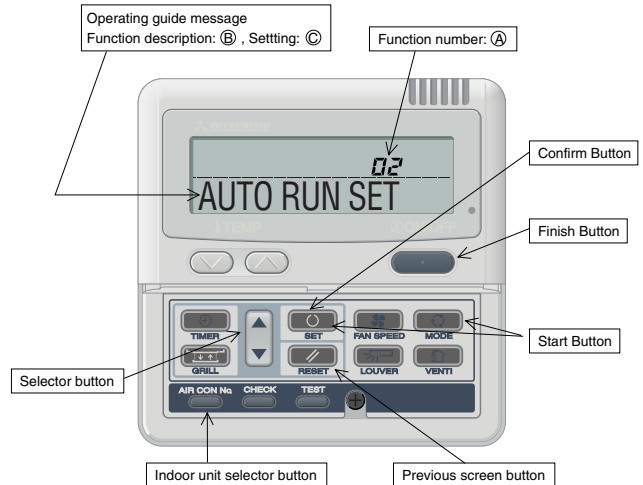

* When “02 AUTO RUN SET” is selected.



When "I/U FUNCTION ▲" is selected.

- ① The screen display will be switched as follows:
 "◀ I/U SELECT" → "○ SET" → "I/U No.00" (blinking)

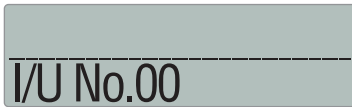

- ② Press either ▲ or ▼ button.
 Select the indoor unit number that you want to change settings. If only one indoor unit is connected, the indoor unit number will not change, so please proceed to Step ③.
 If "ALL I/U ▼" is selected while indoor group control is in effect, you can set all units to the same settings.

- ③ Press the SET button.
 Indoor unit number indication will change from blinking to lit continuously, The screen display will be switched as follows:
 "DATA LOADING" (blinking for about 2 to 23 seconds) → "▶ FUNCTION" → "05 EXTERNAL INPUT SET"
 (Function number: Ⓐ, Function description: Ⓑ)

* When "05EXTERNAL INPUT SET" is selected.





























- ④ Press either ▲ or ▼ button.
 "Function number: Ⓐ, Function description: Ⓑ" from the list of indoor unit functions will be displayed one by one. Select a desired function.
 ⑤ Press the SET button.
 The screen display will be switched as follows: "▶ SETTING" → "Setting: Ⓒ" (ex. "LEVEL INPUT")



- ⑥ Press either ▲ or ▼ button.
 A list "Setting: Ⓒ" will be displayed one by one. Select your desired setting.
 ⑦ Press the SET button.
 The selected setting is displayed for 2 seconds, then followed by "SET COMPLETE" and the function setting process is completed.
 Then the screen display will be switched to "Function number: Ⓐ, Function description: Ⓑ" so if you want to continue to set another function, repeat the steps as explained above. To finish the function setting process, please proceed to Step 8.
 ⑧ Press AIR CON No. button.
 The screen display will go back to the indoor unit selection screen (ex. "I/U No.00").
 (g) Press the ON/OFF button.
 This ends a function setting process. Even if a function setting process is not completed, this ends the process.
 Please note that any setting that is not completed will become void.

- **Pressing the RESET button during a function setting process will allow you to go back the previous step. Please note that any setting that is not completed will become void.**
- **Method of checking the current setting**
 While following the above mentioned step, the setting that appears when the SET button is pressed for each "Function number: Ⓐ, Function description: Ⓑ" is the current setting "Setting: Ⓒ". (When "ALL I/U ▼" is selected, the setting of the indoor unit with the lowest number is displayed)
- **Settings are stored in the controller and not lost even a power outage occurs.**

(3) Changing the remote control set temperature range

- (a) It is possible to change the set temperature range using the remote control.
- 1) The upper and lower set temperature limits can be set from the remote control.
Upper limit value setting: Effective during heating. The temperature can be set within a range of 20~30°C.
Lower limit value setting: Effective when running in modes other than the heating mode (AUTO, COOL, FAN, DRY): The temperature can be set within a range of 18~26°C.
 - 2) If the upper and lower limits are set using this function, the following controls are active.
- (b) When and TEMP RANGE SET under “FUNCTION” the function setting mode is DISP CHANGE
- 1) If you are setting the upper limit,
 - ① If a temperature that is greater than the upper limit during heating is set from the remote control.
The unit runs for 30 minutes at the set temperature, then it automatically transmits the upper limit temperature. The display on the remote control also approaches that temperature.
 - ② During heating, if the upper limit value is set at a temperature below the upper limit value:
The set temperature is transmitted.
 - 2) If the lower limit is set
 - ① If a temperature that is lower than the lower limit value is set from the remote control. When running in an operation mode other than the heating mode: the unit runs at the set temperature for 30 minutes, then it automatically transmits the lower limit temperature.
 - ② If a temperature that is higher than the lower limit value is set when running in a mode other than the heating mode:
It transmits the set temperature.
- (c) When and TEMP RANGE SET under the “FUNCTION” the function setting mode is NO DISP CHANGE.
- 1) If the upper limit is set
 - ① During heating, if a temperature that is higher than the upper limit is set from the remote control:
The upper limit value is transmitted. However, the remote control display does not approach the upper limit value, but remains on the set temperature.
 - ② During heating, if the temperature is set at a value lower than the upper limit value:
The set temperature is transmitted.
 - 2) If the lower limit is set
 - ① When in an operating mode other than the heating mode, if a temperature that is lower than the lower limit value is set from the remote control:
The lower limit value is transmitted. However, the remote control display does not approach the lower limit value, but remains on the set temperature.
 - ② When in an operating mode other than the heating mode, if a temperature that is higher than the lower limit value is set:
The set temperature is transmitted.
- (d) Setting the upper and lower limit values
- 1) Stop the air conditioner, then press the SET and MODE buttons simultaneously for 3 seconds or longer. If you press “  SET” → “  SET” → “FUNCTION SET ▼” the display changes.
 - 2) Press the  button, then change the “TEMP RANGE ▲” display.
 - 3) Press the SET button and enter the temperature range setting mode.
 - 4) Using the   buttons, select the “Hi LIMIT SET ▼” or “Lo LIMIT SET ▲,” then fix it by pressing SET.
 - 5) If you selected “Hi LIMIT SET,” (enabled during heating)
 - ① “   SET UP” → “Hi LIMIT 28°C ” (blinking) is displayed.
 - ② Using the “ ” temperature setting buttons, select the upper limit value. Display Example: “Hi LIMIT 26°C ” (blinking)
 - ③ Press the SET button to fix the setting. Display example: “Hi LIMIT 26°C” (lights up for 2 seconds)
After the fixed upper limit value lights up for 2 seconds, the display returns to the “Hi LIMIT SET ▼” display in item d).
 - 6) If “Lo LIMIT SET ▲” was selected (enabled during COOL, DRY and FAN)
 - ① “   SET UP” → “Lo LIMIT 20°C ” (blinking) is displayed.
 - ② Using the “ ” temperature setting buttons, select the lower limit. Display example: “Lo LIMIT 24°C  ” (blinking)
 - ③ Press the SET button to fix the setting. Display example: “Lo LIMIT 24°C” (lights up for 2 seconds)
After the fixed lower limit value lights up for 2 seconds, the display returns to the “Lo LIMIT SET ▲” display in item 4).
 - 7) Pressing the ON/OFF button stops the operation.
(Operation stops even if the ON/OFF button is pressed during setting, and the stopped state returns. However, if setting is not completed, it is not valid, so use caution.)
- ◆ If the RESET button is pressed during setting, the previous setting screen is displayed.

- If the RESET button is pressed during a setting operation, the display returns to the previously displayed setting screen. However, settings which have not been fixed become invalid, so exercise caution.
- * If “NO DISP CHANGE” is selected in No. 12, “TEMP RANGE SET” of the remote control’s functions, of the function setting modes, the remote control’s display does not change even if the temperature range has been changed.

(Example) If the upper limit is set at 28°C

Function No. A	Function Contents B	Setting Contents C	Control Contents
12	TEMP RANGE SET	DISP CHANGE	The remote control’s display and sent data upper limit changes to 28°C.
		NO DISP CHANGE	The remote control’s display upper limit remains at 30°C and only the upper limit of the sent data is changed to 28°C.

7.10 Super link adapter (SC-AD-ER)

(1) Functions

- Transmits the settings from the Super link option to the indoor units.
- Returns the priority indoor unit data in response to a data request from the Super link option.
- Inspects the error status of connected indoor units and transmits the inspection codes to the Super link option.
- A maximum of 16 units can be controlled (if in the same operation mode).

(2) Wiring connection diagram

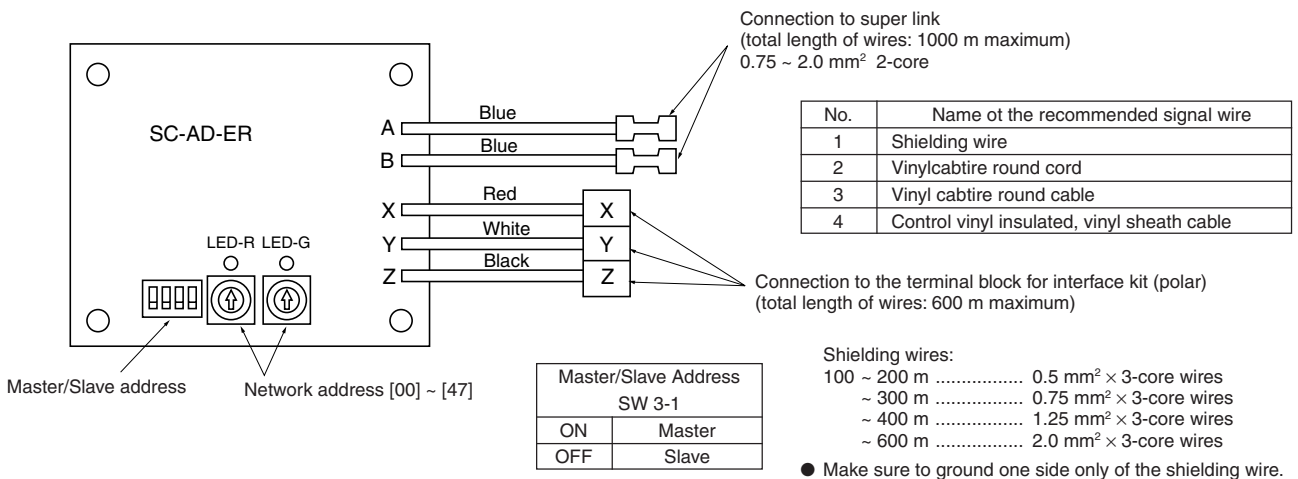

- Set the super link network address with SW1 (10-position) and SW2 (1-position).
- Without a remote control (no wired remote control and no wireless remote control), set SC-AD-ER SW3-1 to ON (Master).

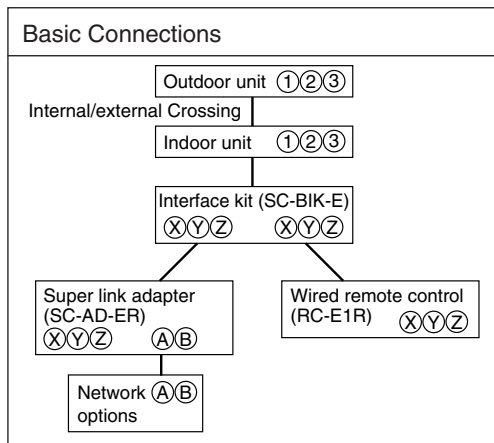

(3) Installation

(a) Accessories

Printed circuit board	Metal box	Metal cover	Insulating rubber sheet
Pan head screw ø4 × 8 ℓ 2 units	Locking support for fixing the printed circuit board made of nylon 4 units	Band for binding wires, 5 pieces	Binding band

(b) Metal box dimension

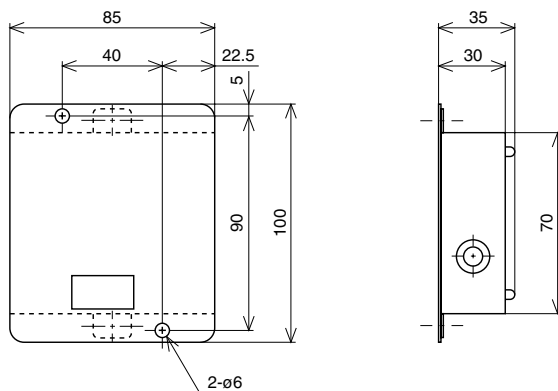

(c) Installation Outline

- Secure the installing board to the metal box with the locking supports.
- The wires are put through a grommet and bound into a bundle with a binding band.
- Attaching to the outside of a indoor unit.
- Attaching to the back of a wired remote control.

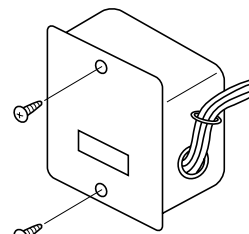
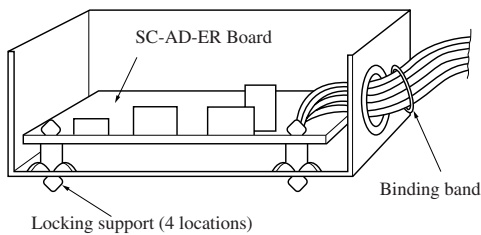

► In this case, attach the metal cover.

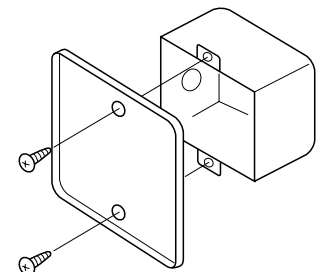

► In this case, attach directly to the lower case of the wired remote control.

(4) Inspection Displays

Check the green LED and red LED flashing at the SC-AD-ER board.

SC-AD-ER board LED		Inspection mode	Display on the central control device of the network
Red	Green		
light off	flashing	Normal communication	
light off	light off	<ul style="list-style-type: none"> Open circuit at the wired remote control signal wire (X) or (Z). Short circuit at the wired remote control signal wire. (between X - Z) Power source of the indoor wired remote control is out of order. 	
1 flashing	flashing	<ul style="list-style-type: none"> Open circuit at the super link signal wire (A) or (B). Short circuit at the super link signal wire. (between A - B) The super link circuit is out of order. 	
2 flashings	flashing	Poor SC-AD-ER board address setting. (setting at No. 48 or 49)	
3 flashings	flashing	<ul style="list-style-type: none"> Open circuit at the wired remote control signal wire (Y). Short circuit at the wired remote control signal wire. (between X - Y or between X - Z) In the case of opening without a wired remote control, SC-AD-ER board "Master" setting is not performed. The wired remote control signal circuit is out of order. 	E1
4 flashings	flashing	The address is repeated in the SC-AD-ER board and the indoor unit connected to the link network.	E2
flashings	flashing	The address is repeated in the SC-AD-ER board and the outdoor unit connected to the link network.	E31

7.11 Operation permission/prohibition control

The air conditioner operation is controlled by releasing the jumper wire (J3) on the interface kit board and inputting the external signal into the CnT.

- (1) The operation mode is switched over between Permission and Prohibition by releasing the jumper wire (J3) on the interface kit control board.**

When the jumper wire (J3) is short circuited	When the jumper wire (J3) is released
<p>Normal operation is enable (when shipping)</p> <p>When CnT input is set to ON, the operation starts and if the input is set to OFF, the operation stops.</p> <p>For the CnT and remote control inputs, the input which is activated later has priority and can start and stop the operation.</p>	<p>Permission / Prohibition mode</p> <p>When Cnt input is set to ON, the operation mode is changed to permission and if input is set to OFF the operation is prohibited.</p>

- (2) When the CnT input is set to ON (Operation permission)**

- (a) The air conditioner can be operated or stopped by the remote control signal.
(When the "CENTER" mode is set, the operation can be controlled only by the center input.)
- (b) When the CnT input is changed from OFF to ON, the air conditioner operation mode is changed depending on the status of the jumper wire (J1) on the interface kit board.

When the jumper wire (J1) is short circuited	When the jumper wire (J1) is released
<p>The signal (a) above starts the air conditioner. (Shipping status)</p>	<p>When the CnT input is set to ON, the air conditioner starts operation. After that, the operation of the air conditioner depends on (a) above. (Local status)</p>

- (3) When the CnT input is set to OFF (Prohibition)**

- (a) The air conditioner cannot be operated or stopped by the remote control signal.
- (b) The air conditioner operation is stopped when the CnT input is changed from ON to OFF.

- (4) When the operation permission / prohibition mode is set to effective by the indoor function setting selected by the remote control, the operation depends on (1) above.**

7.12 External control (remote display)/control of input signal

(1) External control (remote display) output

Following output connectors (CNT) are provided on the printed circuit board of interface kit.

- **Operation output:** Power to engage DC 12V relay (provided by the customer) is outputted during operation.
- **Heating output:** Power to engage DC 12V relay (provided by the customer) is outputted during the heating operation.
- **Compressor OPERATION output:** Power to engage DC 12V relay (provided by the customer) is outputted while the compressor is operating.
- **MALFUNCTION output:** When any error occurs, the power to engage DC 12V relay (provided by the customer) is outputted.

(2) Control of input signal

Control of input signal (switch input, timer input) connectors (CNT) are provided on the control circuit board of interface kit.

However, when the operation of air conditioner is under the Center Mode, the remote control by CnT is invalid.

(a) Level input

If the factory settings (Jumper wire J1 EXTERNAL INPUT on the PCB of interface kit) are set, or "LEVEL INPUT" is selected in the wired remote control's indoor unit settings.

- 1) Input signal to CnT OFF → ON - - - - Air conditioner ON
- 2) Input signal to CnT ON → OFF - - - - Air conditioner OFF

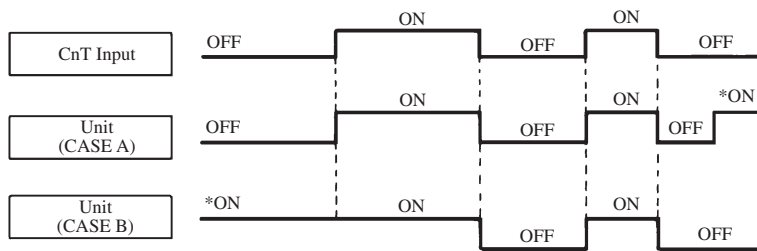

Note (1) The ON with the * mark indicates an ON operation using the remote control unit switch, etc.

(b) Pulse input

When Jumper wire J1 on the PCB of interface kit is cut at the field or "PULSE INPUT" is selected in the wired remote control's indoor unit settings.

Input signal to CnT becomes valid at OFF → ON only and the motion of air conditioner [ON/OFF] is inverted.

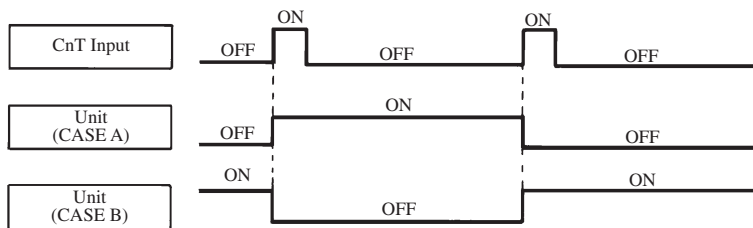

8 REFRIGERANT PIPING INSTALLATION/SERVICING MANUAL FOR AIR CONDITIONERS USING R410A

(These materials are extracted from document issued by The Japan Refrigeration and Air Conditioning Industry Association)

8.1 Outline

8.1.1 Refrigerant R410A

(1) Adoption of R410A in air conditioners

In 1974, it was pointed out that the ozone layer in the upper stratosphere (about 20 ~ 40 km above ground) might have been damaged by the ozone depleting substances such as CFC (chlorofluorocarbon) and HCFC (hydrochlorofluorocarbon). Since that time, many countries across the world have endeavored to take countermeasures against the ozone depletion.

As a refrigerant belonging to the HCFCs, the conventional refrigerant (R22) used in air conditioners also tends to deplete the ozone layer. Therefore, complying with the provisions of the international regulations (i.e. Montreal Protocol concerning the Ozone Depleting Substances) and national laws & Regulations concerned, it is necessary to replace R22 with other types of refrigerant which do not deplete the ozone layer.

A refrigerant composed of hydrogen (H), fluorine (F) and carbon (C), is called an HFC and does not deplete the ozone layer. One HFC's is R410A whose pressure is about 1.6 times higher than R22 and whose energy efficiency is almost comparable to that of R22 at the same refrigerant temperature.

(2) Chemical characteristics of R410A

a) Chemical stability

Like R22, R410A is a chemically stable, less toxic and non-flammable refrigerant. However, as in the case of R22, the specific gravity of its vapour is larger than that of air and should it leak in an airtight room it may stay at a low level and cause an oxygen starvation accident. It may also, should it come in direct contact with fire, cause a poisonous gas to occur, so be sure to handle it only in a well ventilated area.

b) Composition changes (Pseudo-azeotropic characteristics)

R410A is a pseudo-azeotropic mixed refrigerant composed of two constituents - R32 and R125. "Quasi-azeotropic" condition refers to a state in which the dew-point curve and boiling-point curve - gas-liquid equilibrium curves (pressure constant) - almost lie on top of each other, and a multi-constituent refrigerant having this chemical characteristic incurs less composition changes even when evaporation (or condensation) as a phase change occurs. Consequently, even when refrigerant leaks from the gas phase somewhere in the piping installation, the composition of circulated refrigerant incurs less changes.

Therefore, R410A can be treated in almost a same manner as a mono-constituent refrigerant like R22 is treated. When actually charging R410A, however, do so from the liquid phase side by taking into account the phenomenon that, when put in a cylinder, the composition changes a little between gas and liquid phases.

c) Pressure characteristics

As shown in Table 2, since R410A's vapor pressure is about 1.6 times higher than that of R22 at the same temperature, perform installation/service with special tools and materials which are exclusive for R410A and can withstand high pressure.

Table 1. Comparison of thermophysical properties of R410A and R22

	R410A	R22
Composition (wt%)	R32/R125 (50/50)	R22 (100)
Molecular weight	72.6	86.5
Boiling point (°C)	-51.4	-40.8
Vapor pressure (25°C, MPa)	1.56	0.94
Saturated vapor density (25°C, kg/m ³)	64.0	44.4
Inflammability	Nonflammable	Nonflammable
Ozone depletion potential (ODP)	0	0.055
Global warming potential (GWP)	1730	1700

Source: List of thermophysical properties compiled by the Japan society of refrigeration and air conditioning, NIST REFPROP V5.10, etc.

Table 2. Comparison of saturated vapor pressure of R410A and R22
unit: MPa

Refrigerant Temperature (°C)	R410A	R22
-20	0.30	0.14
0	0.70	0.40
20	1.35	0.81
40	2.32	1.43
60	3.73	2.33
65	4.15	2.60

Source: List of thermophysical properties compiled by the Japan society of refrigeration and air conditioning, NIST REFPROP V5.10, etc.

(3) Lubricating oils for R410A

As the lubricating oils for R22, mineral oils, alkylbenze synthetic oils, etc. have so far been used. As R410A features less solubility with these conventional lubricating oils such as mineral oils, the lubricating oils tend to stay within the refrigeration cycle. As the lubricating oils highly soluble with R410A, ester, ethereal and other synthetic oils are available. However, as these synthetic oils are very hygroscopic, they must be treated even more carefully than the conventional lubricating oils. Furthermore, if these synthetic oils are mixed with mineral oils, alkylbenzene synthetic oils, etc., they may deteriorate, and block the capillary tubes, or cause the compressor to fail. So, never mix these synthetic oils.

8.1.2 Safety during installation/servicing

As R410A's pressure is about 1.6 times higher than that of R22, improper installation/servicing may cause a serious trouble. By using tools and materials exclusive for R410A, it is necessary to carry out installation/servicing safely while taking the following precautions into consideration.

1) Never use refrigerant other than R410A in an air conditioner which is designed to operate with R410A.

2) If a refrigeration gas leakage occurs during installation/servicing, be sure to ventilate fully.

If the refrigerant gas comes into contact with fire, a poisonous gas may occur.

3) When installing or removing an air conditioner, do not allow air or moisture to remain in the refrigeration cycle. Otherwise, pressure in the refrigeration cycle may become abnormally high so that a rupture or personal injury may be caused.

4) After completion of installation work, check to make sure that there is no refrigeration gas leakage.

If the refrigerant gas leaks into the room, coming into contact with fire in the fan driven heater, space heater, etc., a poisonous gas may occur.

5) When an air conditioning system charged with a large volume of refrigerant (e.g. multi type air conditioner) is installed in a small room, it is necessary to exercise care so that, even when refrigerant leaks, its concentration does not exceed the marginal level.

If the refrigerant gas leakage occurs and its concentration exceeds the marginal level, an oxygen starvation accident may result.

6) Be sure to carry out installation or removal according to the installation manual.

Improper installation may cause refrigeration trouble, water leakage, electric shock, fire, etc.

7) Unauthorized modifications to the air conditioner may be dangerous. If a breakdown occurs please call a qualified air conditioner technician or electrician.

Improper repair's may result in water leakage, electric shock and fire, etc.

8.2 Refrigerant piping installation

8.2.1 Piping materials and joints used

For the refrigerant piping installation, copper pipes and joints are mainly used. Copper pipes and joints suitable for the refrigerant must be chosen and installed. Furthermore, it is necessary to use clean copper pipes and joints whose interior surfaces are less affected by contaminants.

(1) Copper pipes

It is necessary to use seamless copper pipes which are made of either copper or copper alloy and it is desirable that the amount of residual oil is less than 40 mg/10m. Do not use copper pipes having a collapsed, deformed or discolored portion (especially on the interior surface). Otherwise, the expansion valve or capillary tube may become blocked with contaminants.

As an air conditioner using R410A incurs pressure higher than when using R22, it is necessary to choose adequate materials.

Thicknesses of copper pipes used with R410A are as shown in Table 3. Never use copper pipes thinner than 0.8 mm even when it is available on the market.

Table 3. Thicknesses of annealed copper pipes

Nominal diameter	Outer diameter (mm)	Thickness (mm)	
		R410A	[ref.] R22
1/4	6.35	0.80	0.80
3/8	9.52	0.80	0.80
1/2	12.70	0.80	0.80
5/8	15.88	1.00	1.00

(2) Joints

For copper pipes, flare joints or socket joints are used. Prior to use, be sure to remove all contaminants.

a) Flare joints

Flare joints used to connect the copper pipes cannot be used for pipings whose outer diameter exceeds 20 mm. In such a case, socket joints can be used.

Sizes of flare pipe ends, flare joint ends and flare nuts are as shown in Tables 5~8 (see on page 72, 73) below. Also, union, half union, Tee-type union and elbow-type union shapes are generally used (see Fig 1).

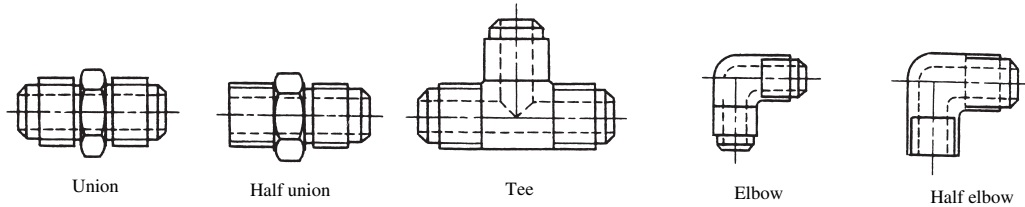

Fig.1 Flare joints

b) Socket joints

Socket joints are such that they are brazed for connections, and used mainly for thick pipings whose diameter is larger than 20 mm. Thicknesses of socket joints are as shown in Table 4. Socket, elbow-type and tee-type shapes are generally used (see Fig. 2).

Table 4. Minimum thicknesses of socket joints

Nominal diameter	Reference outer diameter of copper pipe jointed (mm)	Minimum joint thickness (mm)
1/4	6.35	0.50
3/8	9.52	0.60
1/2	12.70	0.70
5/8	15.88	0.80

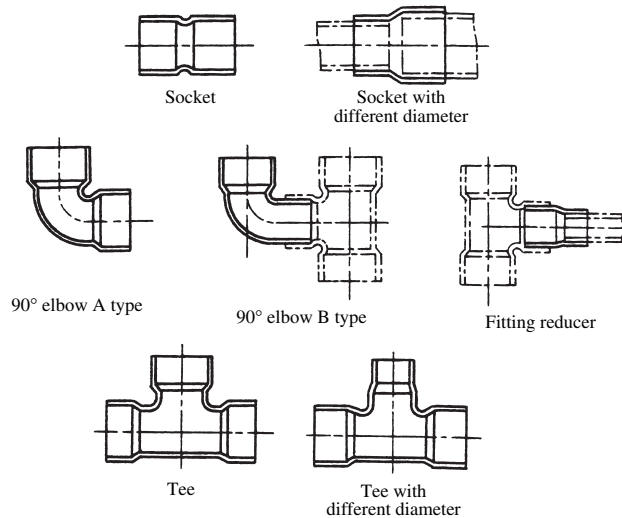

Fig.2 Socket joints

8.2.2 Processing of piping materials

When performing the refrigerant piping installation, care should be taken to ensure that water or dust does not enter the pipe interior, that no other oil other than lubricating oils used in the installed air conditioner is used, and that refrigerant does not leak. When using lubricating oils in the piping processing, use such lubricating oils whose water content has been removed. When stored, be sure to seal the container with an airtight cap or any other cover.

(1) Flare processing procedures and precautions

a) Cutting the pipe

By means of a pipe cutter, slowly cut the pipe so that it is not deformed.

b) Removing burrs and chips

If the flared section has chips or burrs, refrigerant leakage may occur. Carefully remove all burrs and clean the cut surface before installation.

c) Insertion of flare nut

d) Flare processing

Make certain that a clamp bar and copper pipe have been cleaned.

By means of the clamp bar, perform the flare processing correctly.

Use either a flare tool for R410A or conventional flare tool.

Flare processing dimensions differ according to the type of flare tool. Be careful. When using a conventional flare tool, be sure to secure “dimension A” by using a gage for size adjustment.

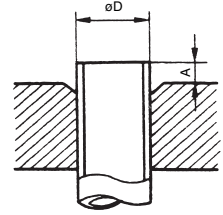

Fig.3 Flare processing dimensions

Table 5. Dimensions related to flare processing for R410A

Nominal diameter	Outer diameter (mm)	Thickness (mm)	A (mm)		
			Flare tool for R410A Clutch type	Conventional flare tool	
				Clutch type	Wing nut type
1/4	6.35	0.8	0~0.5	1.0~1.5	1.5~2.0
3/8	9.52	0.8	0~0.5	1.0~1.5	1.5~2.0
1/2	12.70	0.8	0~0.5	1.0~1.5	2.0~2.5
5/8	15.88	1.0	0~0.5	1.0~1.5	2.0~2.5

Table 6. Dimensions related to flare processing for R22

Nominal diameter	Outer diameter (mm)	Thickness (mm)	A (mm)		
			Flare tool for R410A Clutch type	Conventional flare tool	
				Clutch type	Wing nut type
1/4	6.35	0.8	0~0.5	0.5~1.0	1.0~1.5
3/8	9.52	0.8	0~0.5	0.5~1.0	1.0~1.5
1/2	12.70	0.8	0~0.5	0.5~1.0	1.5~2.0
5/8	15.88	1.0	0~0.5	0.5~1.0	1.5~2.0

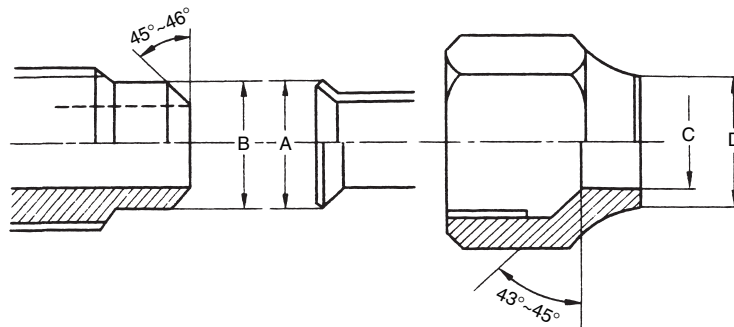

Fig.4 Relations between flare nut and flare seal surface

Table 7. Flare and flare nut dimensions for R410A

[unit: mm]

Nominal diameter	Outer diameter (mm)	Thickness (mm)	Dimension (mm)				Flare nut width
			A	B	C	D	
1/4	6.35	0.8	9.1	9.2	6.5	13	17
3/8	9.52	0.8	13.2	13.5	9.7	20	22
1/2	12.70	0.8	16.6	16.0	12.9	23	26
5/8	15.88	1.0	19.7	19.0	16.0	25	29

Table 8. Flare and flare nut dimensions for R22

[unit: mm]

Nominal diameter	Outer diameter (mm)	Thickness (mm)	Dimension (mm)				Flare nut width
			A	B	C	D	
1/4	6.35	0.8	9.0	9.2	6.5	13	17
3/8	9.52	0.8	13.0	13.5	9.7	20	22
1/2	12.70	0.8	16.2	16.0	12.9	20	24
5/8	15.88	1.0	19.4	19.0	16.0	23	27

(2) Flare connecting procedures and precautions

- a) Make sure that the flare and union portions do not have any scar or dust, etc.
- b) Correctly align the processed flare surface with the union axis.
- c) Tighten the flare with designated torque by means of a torque wrench. The tightening torque for R410A is same as that for conventional R22. Incidentally, when the torque is weak, the gas leakage may occur. When it is strong, the flare nut may crack and may be made nonremovable. When choosing the tightening torque, comply with values designated by manufacturers.

Table 9 shows reference values.

Note : When applying oil to the flare surface, be sure to use oil designated by the manufacturer. If any other oil is used, the lubricating oils may deteriorate and cause the compressor to burn out.

Table 9. Tightening torque of flare for R410A [Reference values]

Nominal diameter	Outer diameter (mm)	Tightening torque N·m (kgf·cm)	Tightening torque of torque wrenches available on the market N·m (kgf·cm)
1/4	6.35	14~18 (140~180)	16 (160), 18 (180)
3/8	9.52	33~42 (330~420)	42 (420)
1/2	12.70	50~62 (500~620)	55 (550)
5/8	15.88	63~77 (630~770)	65 (650)

8.2.3 Storage of piping materials

(1) Types and storage of piping materials

Refrigerant piping materials for air conditioners are broadly classified into the following types.

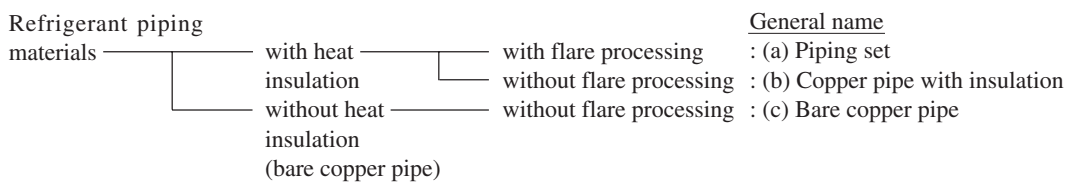

As R410A features pressure about 1.6 times higher than R22, it is necessary to use a copper pipe which has a thickness stated in Table 3 (see on page 70) and which contains less contaminants. It is necessary to carefully treat/store copper pipes so that they are not collapsed, deformed or damaged. Due care must also be exercised so that foreign matters such as dust and water do not enter the pipe interior.

A piping set's open end is sealed with a cap, etc. When storing it, make sure that it is sealed securely. When storing a clad copper pipe or bare copper pipe, securely seal the opening with pinching, taping, etc.

(2) Identification

a) Piping set

A copper pipe as piping set for R410A must have a thickness as stated in Table 3 (see on page 70), and, as shown in Tables 5 and 6 (see on page 72), it also differs from R22 in flare processing and flare nut dimensions. So, it is necessary to choose a piping set suitable for R410A.

b) Copper pipe with insulation

Before using a copper pipe with insulation, make sure that it has a thickness designated for R410A.

c) Bare copper pipe

It is necessary to use a bare copper pipe which has a thickness designated in Table 3 (see on page 70) and contains less contaminants. As the bare copper pipe surface is naked, it is necessary to treat it with exceeding care and adopt a means for identification to prevent improper usage by making it easily discriminable from other piping materials.

(3) Precautions before installation

Observe the following precautions when performing the piping connection at the site.

a) Keep any open ends of pipes be sealed with a cap, etc. until connected with the equipment.

b) Exercise great care when performing piping installation on a rainy day.

When water enters into the piping, the lubricating oil may deteriorate and cause the equipment to fail.

c) Carry out the piping connection in as short a time as possible.

If the piping is left open for a long period, fully purge the interior with nitrogen gas or dry it with a vacuum pump.

8.2.4 Brazing

(1) Processing the connected parts

As brazing is molten between the joined surfaces to yield high adhesive strength, it is necessary to secure a wide enough space to be joined and also an adequate clearance between the joined surfaces. Copper pipe joints' minimum insertion depths, outer pipe diameters and clearances between outer and inner pipe diameters are as shown in Table 10. In the case of bronze brazing filler, when the clearance is about 0.05~0.1mm, the pipes can be connected most strongly.

Table 10. Copper pipe joints' minimum insertion depths and clearances

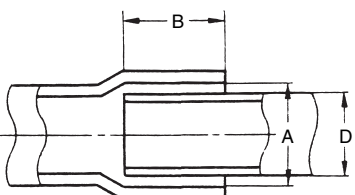

Outer pipe diameter D (mm)	Minimum insertion depth B (mm)	Clearance (A-D) × 1/2 (mm)
5~8	6	0.05~0.35
8~12	7	0.05~0.35
12~16	8	0.05~0.45

* When joining the pipes, either the pipe ends are processed, or pipes are connected by brazing with a socket joint.

(2) Brazing filler metal

a) Alloy brazing filler

An alloy mainly composed of silver and copper is used to join iron, copper or copper alloy. Although it excels in solderability, it is relatively expensive.

b) Phosphor bronze brazing filler

Phosphor bronze brazing filler is generally used to join copper or copper alloy.

c) Low temperature solder

An alloy of tin and lead. An ordinary type of solder. Since it is weak in adhesive strength, it should not be used for refrigerant pipe brazing.

* Cautions:

- 1) BCuP tends to react with sulphur and produce a fragile compound water solution, which may cause a gas leakage. So, use any other type of brazing filler at a hot spring resort, etc., and coat the surface with a paint.
- 2) When performing brazing again at the time of servicing, use the same type of brazing filler.

(3) Flux

a) Reasons for the use of flux

- By removing the oxide film and any foreign matter on the metal surface, it assists the flow of brazing filler.
- In the brazing process, it prevents the metal surface from being oxidized.
- By reducing the brazing filler's surface tension, the brazing filler adheres better to the treated metal.

b) Properties required for flux

- Temperature at which flux is active coincides with the brazing temperature.
- Due to a wide effective temperature range, flux is hard to carbonize.
- It is easy to remove slag after brazing.
- The corrosive action to the treated metal and brazing filler is negligible.
- Excels in coating performance and is harmless to the human body.

As the flux works in a complicated manner as described above, it is necessary to choose an adequate type of flux according to the type and shape of treated metal, type of brazing filler and brazing method, etc.

c) Types of flux

• Incorruptible flux

Generally, it is a compound of borax and boric acid.

Effective in cases where the brazing temperature is higher than 800°C.

• Activated flux

Most of fluxes generally used for silver brazing fall under this type.

It features an increased oxide film removing capability due to the addition of compounds such as potassium fluoride, potassium chloride and sodium fluoride, to the borax-boric acid compound.

* Cautions:

- ① Remove the flux after brazing.
- ② When chlorine contained in the flux stays within the pipe, the lubricating oil deteriorates. So, use a flux which does not contain chlorine.
- ③ When adding water to the flux, use water which does not contain chlorine (e.g. distilled water or ion-exchange water).

(4) Brazing

As brazing requires sophisticated techniques and experiences, it must be performed by a qualified person.

In order to prevent the oxide film from occurring in the pipe interior during brazing, it is effective to proceed with brazing while letting dry nitrogen gas (N₂) flow.

<Brazing method for preventing oxidation>

- a) Attach a reducing valve to the nitrogen gas cylinder
- b) Use a copper pipe to direct the nitrogen gas into the piping, and attach a flowmeter to the nitrogen gas cylinder.
- c) Apply a seal onto the clearance between the piping and inserted pipe for the nitrogen gas in order to prevent the nitrogen gas from flowing backward.
- d) When the nitrogen gas is flowing, be sure to keep the piping end open.
- e) Adjust the flow rate of nitrogen gas so that it is lower than 0.05m³/h, or 0.02MPa (0.2kgf/cm²) by means of the reducing valve.
- f) After taking the steps above, keep the nitrogen gas flowing until the piping cools down to a certain extent (i.e. temperature at which pipes are touchable with finger).
- g) Completely remove the flux after brazing.

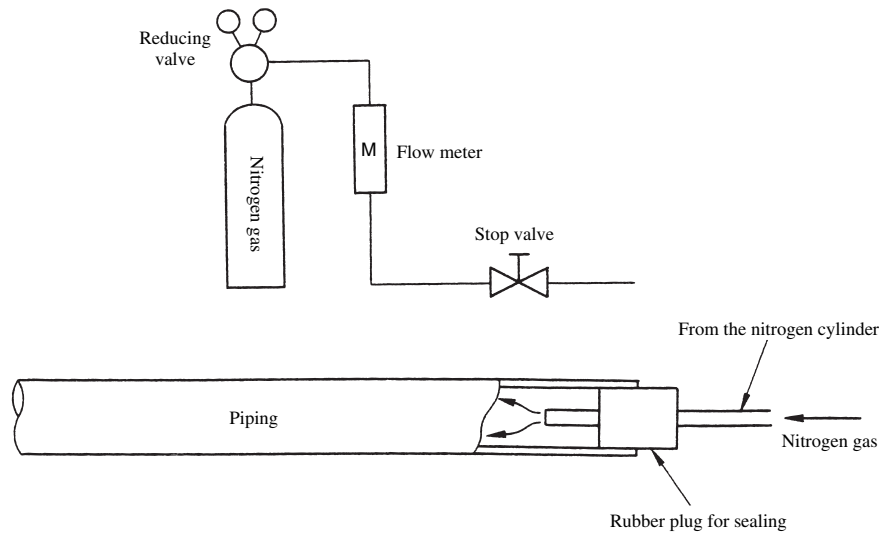

Fig.5 Prevention of oxidation during brazing

* Cautions during brazing

① General cautions

- 1) The brazing strength should be high as required.
- 2) After operation, airtightness should be kept under a pressurized condition.
- 3) During brazing do not allow component materials to become damaged due to overheating.
- 4) The refrigerant pipe work should not become blocked with scale or flux.
- 5) The brazed part should not restrict the flow in the refrigerant circuit.
- 6) No corrosion should occur from the brazed part.

② Prevention of overheating

Due to heating, the interior and exterior surfaces of treated metal may oxidize. Especially, when the interior of the refrigerant circuit oxidizes due to overheating, scale occurs and stays in the circuit as dust, thus exerting a fatally adverse effect. So, make brazing at adequate brazing temperature and with a minimum of heating area.

③ Overheating protection

In order to prevent components near the brazed part from overheating damage or quality deterioration due to flame or heat, take adequate steps for protection such as (1) by shielding with a metal plate, (2) by using a wet cloth, and (3) by means of heat absorbent.

④ Movement during brazing

Eliminate all vibration during brazing to protect brazed joints from cracking and breakage.

⑤ Oxidation preventive

In order to improve the brazing efficiency, various types of antioxidant are available on the market. However, the constituents of these are widely varied, and some are anticipated to corrode the piping materials, or adversely affect HFC refrigerant, lubricating oil, etc. Exercise care when using an oxidation preventive.

8.3 Installation, removal and servicing

8.3.1 Tools for R410A

In the case of an air conditioner using R410A, in order to prevent any other refrigerant from being charged accidentally, the service port diameter of the outdoor unit control valve (3-way valve) has been changed. Also, to increase the pressure resisting strength, flare processing dimensions and sizes of opposite sides of flare nuts (for copper pipes with nominal diameters 1/2 and 5/8) have been changed. During installation/service, therefore, prepare tools exclusive for R410A shown in (1) on page 77 and general tools shown in (2) on page 78.

(1) Tools exclusive for R410A

a) Gauge manifold

- As R410A is characterized by high pressure, conventional tools cannot be used.

Table 11. Differences between conventional high/low pressure gauges and those for R410A

	Conventional gauges	Gauges exclusive for R410A
High pressure gauge (red)	-0.1~3.5MPa -76 cmHg~35 kgf/cm ²	-0.1~5.3MPa -76 cmHg~53 kgf/cm ²
Compound gauge (blue)	-0.1~1.7MPa -76 cmHg~17 kgf/cm ²	-0.1~3.8MPa -76 cmHg~38 kgf/cm ²

- In order to prevent any other refrigerant from being charged accidentally, each port of the manifold has been changed in shape.

Table 12. Differences in port size between conventional manifold and that for R410A

	Conventional manifold	Manifold for R410A
Port size	7/16 UNF 20 threads per inch	1/2 UNF 20 threads per inch

b) Charge hose

- As R410A is characterized by high pressure, the pressure resistance of the charge hose has been increased. The material has also been changed to an HFC resistant type, and, as in the case of each port of the manifold, the hose cap size has been changed. Furthermore, for prevention of gas pressure reaction, a charge hose with a valve placed near the cap is also available.

Table 13. Differences between conventional charge hose and that for R410A

		Conventional charge hose	Charge hose for R410A
Pressure resistance	Normal pressure	3.4 MPa (34 kgf/cm ²)	5.1 MPa (51 kgf/cm ²)
	Breaking pressure	17.2 MPa (172 kgf/cm ²)	27.4 MPa (274 kgf/cm ²)
Engineering material		NBR rubber	HNBR rubber internally coated with nylon
Cap size		7/16 UNF 20 threads per inch	1/2 UNF 20 threads per inch

c) Electronic balance for refrigerant charging

- As R410A belonging to the HFCs features high pressure and high evaporating speed, when R410A is charged by using a charging cylinder, R410A in the cylinder cannot be kept in a liquefied state and gasified refrigerant bubbles in the charging cylinder, it becomes difficult to read values. Therefore, it is advisable to adequately use an electronic balance for refrigerant charging.
- An electronic balance for refrigerant charging has higher strength due to its structure with four points of support for refrigerant cylinder weight detection. As the charge hose connecting part has two ports-one for R22 (7/16 UNF 20 threads per inch) and the other for R410A (1/2 UNF 20 threads per inch) - it can also be used for charging the conventional refrigerant.
- Two types of electronic balance for refrigerant charging are available - one for 10kg cylinder and the other for 20kg cylinder.
 - Electronic balance for 10kg cylinder precision $\pm 2g$
 - Electronic balance for 20kg cylinder precision $\pm 5g$
- Refrigerant is charged manually by opening/closing the valve.

d) Torque wrench (for nominal diameters 1/2 and 5/8)

- Along with changes in flare nut sizes for enhanced pressure resisting strength, torque wrenches for R410A differ in opposite side size.

Table 14. Differences between conventional wrenches and those for R410A

	Conventional torque wrench	Torque wrench for R410A
For 1/2 (opposite side \times torque)	24mm \times 55N·m (550 kgf·cm)	26mm \times 55N·m (550 kgf·cm)
For 5/8 (opposite side \times torque)	27mm \times 65N·m (650 kgf·cm)	29mm \times 65N·m (650 kgf·cm)

- e) Flare tool (clutch type)
 - A flare tool for R410A is provided with a large clamp bar receiving hole so that the projection of the copper pipe from the clamp bar can be set at 0~0.5 mm in flare processing, and also features higher spring strength for increased expansion pipe torque. This flare tool can also be used for R22 copper pipe.
- f) Gauge for projection adjustment (used when flare processing is made by using conventional flare tool [clutch type])
 - A gauge 1.0 mm in thickness which helps in easily setting the projection of the copper pipe from the clamp bar at 1.0~1.5 mm.
- g) Vacuum pump adapter
 - It is necessary to use an adapter for preventing vacuum pump oil from flowing back to the charge hose. The charge hose connecting part has two ports - one for conventional refrigerant (7/16 UNF 20 threads per inch) and the other for R410A. If the vacuum pump oil (mineral) mixes with R410A, a sludge may occur and damage the equipment.
- h) Refrigerant cylinder
 - A refrigerant cylinder exclusive for R410A comes identified with refrigerant name and is coated with pink paint as designated by the ARI, U.S.A.
- i) Charge port and packing for refrigerant cylinder
 - According to the charge hose's cap size, a charge port with 1/2 UNF 20 threads per inch and corresponding packing are required.
- j) Gas leakage detector
 - A high sensitivity gas leakage detector exclusive for HFC refrigerant is used. In the case of R410A, the detection sensitivity is about 23g per year.

(2) General tools

- a) Vacuum pump
- b) Torque wrench
 - for 1/4: opposite side 17 mm × $\begin{matrix} (16 \text{ N}\cdot\text{m}) \\ (160 \text{ kgf}\cdot\text{cm}) \end{matrix}$
 - for 1/4: opposite side 17 mm × $\begin{matrix} (18 \text{ N}\cdot\text{m}) \\ (180 \text{ kgf}\cdot\text{cm}) \end{matrix}$
 - for 3/8: opposite side 22 mm × $\begin{matrix} (42 \text{ N}\cdot\text{m}) \\ (420 \text{ kgf}\cdot\text{cm}) \end{matrix}$
- c) Pipe cutter
- d) Reamer
- e) Screwdriver (+, -)
- f) Hacksaw
- g) Hole core drill (ø65 or 70)
- h) Hexagonal wrench (opposite side 4 or 5 mm)
- i) Spanner, or monkey wrench
- j) Tape measure
- k) Thermometer
- l) Clamping ampere meter
- m) Insulation resistance tester (mega tester)
- n) Electro circuit tester
- o) Pipe bender

(3) Applicability of R410A tools to R22 model

Table 15. Applicability of R410A tools to R22 model

	Tools for R410A	Applicable to R22 model
a)	Gauge manifold	×
b)	Charge hose	×
c)	Electronic balance for refrigerant charging	○
d)	Torque wrench (nominal diameter 1/2, 5/8)	×
e)	Flare tool (clutch type)	○
f)	Gauge for projection adjustment*	○
g)	Vacuum pump adapter	○
h)	Refrigerant cylinder	×
i)	Charge port and packing for refrigerant cylinder	×
j)	Gas leakage detector	×

* Used when conventional flare tool (clutch type) is used.

Note: For inquiry, contact your agent.

8.3.2 New installation work (when using new refrigerant piping)

- (1) Air purge by vacuum pump and gas leakage inspection (see Fig. 6)
 - a) Connect the charge hose to the outdoor unit. ①
 - b) Connect the charge hose to the vacuum pump adapter. ②
At this time, keep the control valves in the fully closed position. ③ ④
 - c) Place the handle *Lo* in the fully opened position ⑤, and turn on the vacuum pump's power switch.
During this step, perform evacuating (about 10 ~ 15 minutes); for the evacuating time, refer to the equipment manufacturer's manual.
 - d) When the compound gauge's pointer has indicated -0.1 MPa (-76 cmHg) ⑥, place the handle *Lo* in the fully closed position ⑤, and turn OFF the vacuum pump's power switch
Keep this state for 1~2 minutes, and ascertain that the compound gauge's pointer does not return.
 - e) Fully open the control valves. ③ ④
 - f) Detach the charge hoses. ① ②
 - g) Tightly secure the cap on the service port. ⑦
 - h) After securing the caps on the control valves, check the caps' periphery if there is any gas leakage. ③ ④ ⑦

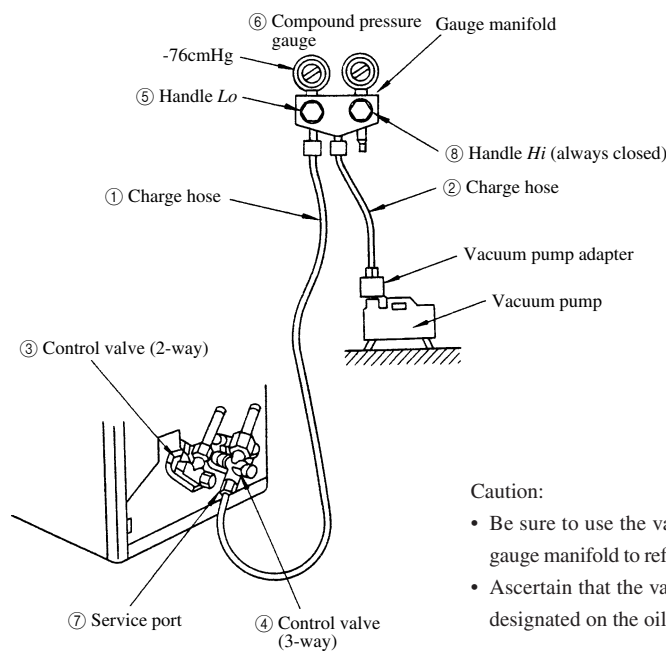

Caution:

- Be sure to use the vacuum pump, vacuum pump adapter and gauge manifold to refer to their instruction manuals beforehand.
- Ascertain that the vacuum pump is filled with oil to the level designated on the oil gauge.

Fig.6 Configuration of air purge by vacuum pump

- (2) Additional refrigerant charging required for refrigerant piping length longer than standard length (The following steps should be taken following the step e) in (1) above. See Fig. 7)
 - a) Set the refrigerant cylinder to the electronic balance, and connect the connecting hoses on the cylinder and electronic balance's connecting port.
* Caution:
Be sure to make setting so that liquid can be charged. When using a cylinder equipped with a siphon, liquid can be charged without turning it upside down.
 - b) Connect the gauge manifold's charge hose to the electronic balance's connecting port. ③ ②
 - c) Open the refrigerant cylinder's valve, and, after opening the charging valve a little, close it. ① ②
 - d) After making zero (0) adjustment, open the charging valve and, by opening the gauge manifold's valve *Lo*, charge the liquid refrigerant. ② ⑤
(Before handling the electronic balance, refer to its instruction manual).
 - e) When the designated amount of refrigerant could not be charged, make additional charging bit by bit by cooling operation (for the amount of each addition, follow the instruction manual prepared by the equipment manufacturer). If the first additional charging was not enough, make the second additional charging after about one minute in the same manner as the first additional charging.
* Caution:
Be sure never to charge a large amount of liquid refrigerant at once to the unit in cooling mode, since liquid is charged from the gas side.

- f) After charging liquid refrigerant into the air conditioner by closing the charging valve, stop operation by fully closing the gauge manifold's valve Lo. ② ⑤
- g) Quickly remove the charge hose from the service port. ⑥
When stopped halfway, refrigerant being cycled will be released.
- h) After securing the caps on the service port and control valve, check the caps' periphery to see if there is any gas leakage. ⑥ ⑦

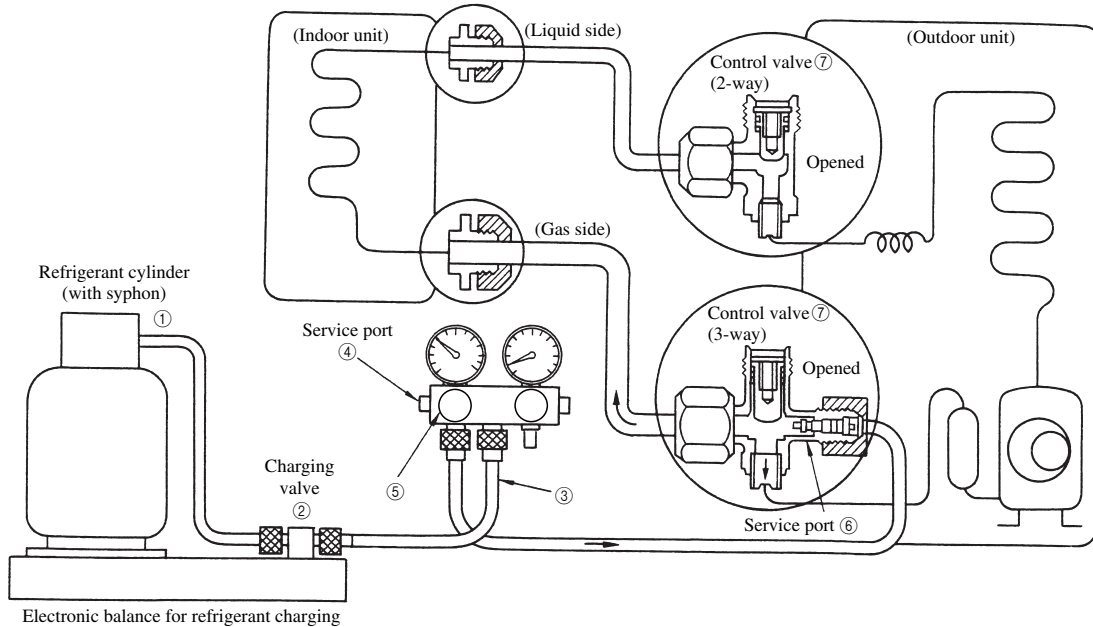

Fig.7 Configuration of additional refrigerant charging

8.3.3 Removal (When using new refrigerant piping)

- (1) Removing the unit
 - a) Recovery of refrigerant from the outdoor unit by pump down
 - At the time of pump down, use a gauge manifold exclusive for R410A.
 - Operating the unit in forced cooling mode, recover refrigerant from the outdoor unit.
(For details of reclaiming steps and precautions, see the instruction manual prepared by the equipment manufacturer)
 - * Caution:
In the case of an outdoor unit which is incapable of pump down, use a refrigerant recovery unit.
 - b) Removing the indoor/outdoor units
 - Remove the piping and wiring between the indoor and outdoor units.
 - Tighten the outdoor unit's control valves and service port with the specified torque.
 - Tighten the capped flare nuts at the indoor/outdoor units connecting part with the specified torque.
 - Remove the indoor/outdoor units.
 - * Caution:
When storing the indoor unit piping in its original position, be careful not to break the piping.
- (2) Installing the unit
 - a) Proceed with the installation following the steps described in "8.3.2 New installation work".

8.3.4 Replacing the unit (Never use the existing refrigerant piping)

Use a brand-new refrigerant piping (1) when replacing the air conditioner using the conventional refrigerant (R22) with an air conditioner using the alternative refrigerant (R410A) or (2) even when replacing the air conditioner using the alternative refrigerant (R410A) with another air conditioner using R410A, as a problem may occur due to differences in pressure characteristics of refrigerant or differences in type of lubricating oil (air conditioners using R410A do not always use the same type of the lubricating oils).

8.3.5 Retrofitting

Do not operate the air conditioner which has used the conventional refrigerant (R22) by charging the alternative refrigerant (R410A). Otherwise, the equipment may cease to function normally and go wrong, or even cause serious problems such as rupture of the refrigeration cycle.

8.3.6 Refrigerant recharging at servicing

When it becomes necessary to recharge refrigerant, charge the specified amount of new refrigerant according to the following steps.

(For details, see the instruction manual prepared by the equipment manufacturer)

- 1) Connect the charge hose to the outdoor unit's service port.
- 2) Connect the charge hose to the vacuum pump adapter. At this time, keep the control valves in the fully opened position.
- 3) Place the handle *Lo* in the fully opened position, and turn ON the vacuum pump's power source. (For the evacuating time, refer to the equipment manufacturer's manual)
- 4) When the compound gauge's pointer has indicated -0.1 MPa (-76 cmHg), place the handle *Lo* in the fully closed position, and turn OFF the vacuum pump's power source. Keep this state for 1 ~ 2 minutes, and ascertain that the compound gauge's pointer does not return.
- 5) Charge liquid refrigerant by using the electronic balance according to the steps described in Section 8.3.2 (2) (pages 79, 80).

8.4 Refrigerant recovery

8.4.1 Recovering procedures

The following procedures for refrigerant recovery represent general procedures, and they may differ between actual cases depending upon the type of refrigerant recovering equipment. The connecting and handling methods for different type of refrigerant recovering equipment may also differ. So, ascertain the details by referring to the respective instruction manuals, etc.

- (1) Checks prior to recovering procedures
 - a) Checking the refrigerant recovering equipment
 - ① Gas leakage [If there is any malfunction, repair it].
 - ② Oil separator [Drain the residual oil].
 - ③ Recovering equipment weighing function, overcharge preventing function (float switch), moisture indicator, drier and other accessory functions [should be adjusted or replaced where necessary].
 - ④ Electrical circuit
 - b) Checking the accessories to the refrigerant recovering equipment
- (2) Preparations for recovering procedures
 - a) Installation of refrigerant recovering equipment
Install the equipment in a place which satisfies the following requirements as much as possible.
 - ① Ambient temperature is higher than 0°C and lower than 40°C.
 - ② A flat and dry floor.
 - ③ A place as close to the air conditioner as possible.
 - b) Preparation of recovering cylinder
A recovering cylinder should be such that it does not go against prohibitions, and is suitable for refrigerant recovered.
 - c) Connect to the power source
 - d) Preparations for air conditioner subjected to refrigerant recovery
 - ① When it is possible to run the air conditioner subjected to refrigerant recovery, perform pump down operation so that refrigerant is contained in the outdoor unit (condenser side).
 - Carry out the pump down operation after confirming the specification of the air conditioner subjected to refrigerant recovery.
 - ② If there is any clogging part (ex. the electronic expansion valve, etc.), fully open such part.

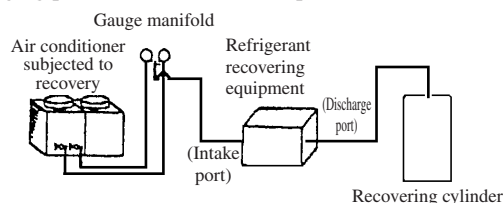

- (3) Connection of refrigerant recovering equipment
 - a) Connect the air conditioner subjected to refrigerant recovery to the refrigerant recovering equipment.
 - ① When there is a service port (port for recovery):
Make connection to the service port (port for recovery) by using a gauge manifold and charge hose.
 - ② When there is no service port (port for recovery):
Make connection in a manner similar to ① above by using a piercing valve.
 - b) Connect the refrigerant recovering equipment to the recovering cylinder.

- (4) Recovering procedures
- According to the instructions for handling the refrigerant recovering equipment (described in the attached instruction manual), operate the equipment to recover refrigerant.
 - During the operation, take care of the following cautions.
 - Ascertain that the refrigerant recovering equipment is running as required and always monitor the state of operation so that adequate steps can be taken in an emergency.
 - During the operation, remain at work site to ensure safety.
 - If you have to leave your work site for any unavoidable reason, stop the operation after ascertaining that the recovering cylinder is not overcharged.
 - During the operation, if the refrigerant recovering equipment's overcharging prevention mechanism operates and the equipment stops automatically, replace the recovering cylinder with an empty one.
 - If the pressure gauge's reading increases after a short time from the accomplishment of recovery and automatic stoppage of the refrigerant recovering equipment, restart the equipment and, if it stops again, finish the recovery.
- (5) Procedures after recovery
- Close the valves on the air conditioner subjected to refrigerant recovery, the refrigerant recovering equipment and the recovering cylinder.
 - Detach the recovering cylinder charged with refrigerant and store it as required by law.

8.4.2 Accessories/tools

In order to carry out R410A recovery, a variety of accessories/tools are required.

Shown below are standard accessories.

(1) Recovering cylinder

- Use a recovering cylinder designated by the equipment manufacturer.
- A detachable cylinder must be such that it complies with the laws and regulations concerned.
- Do not use an ordinary cylinder as a recovering cylinder.

Note 1: A cylinder available when R410A was purchased, is a borrowed one.

Note 2: As a cylinder available when R410A was purchased, is provided with a check valve, it cannot be used as a recovering cylinder.

- Types (by function)

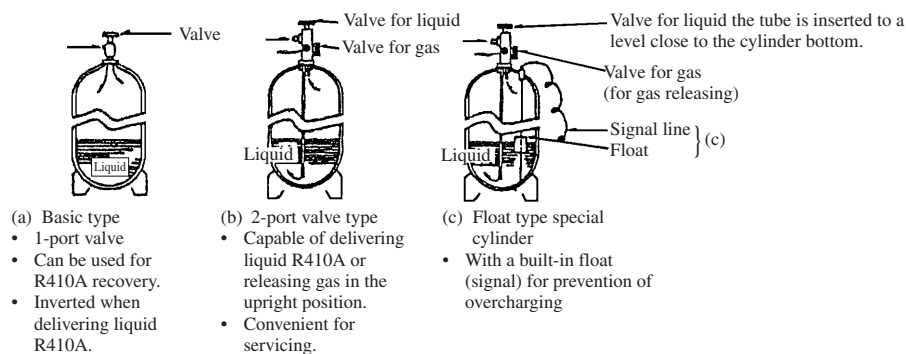

Fig.8 Cylinder types

- Caution

It is prohibited by law to recover R410A into a throw-away service can or one-way cylinder.

(2) Drier

- A desiccant container for removing the water content of R410A.
- A drier should be prepared as expendables.
- Keep the drier sealed just before fitting it.
- Required to protect the R410A recovering equipment.

(3) Connection hose

a) Charge port and charge port packing

- Usually, it is sold independently of a refrigerant cylinder.
- In the case of a two-port cylinder, the diameter may be special. Inquire the manufacture for confirmation.
- A packing is expendables.

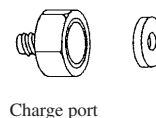

b) Charge hose (pressure resistant hose for fluorocarbon) and packing

- It is 1/4B in thickness and available in various lengths, etc.
- Use a hose whose pressure resisting performance is higher than 5.2 MPa (52 kg/cm²G).
- Generally, a setting fixture is provided only on one end.

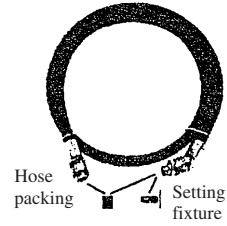

(4) Gauge manifold

- The most important service tool for refrigeration and air conditioner.
- Widely used when charging/recovering R410A while checking gas pressure.

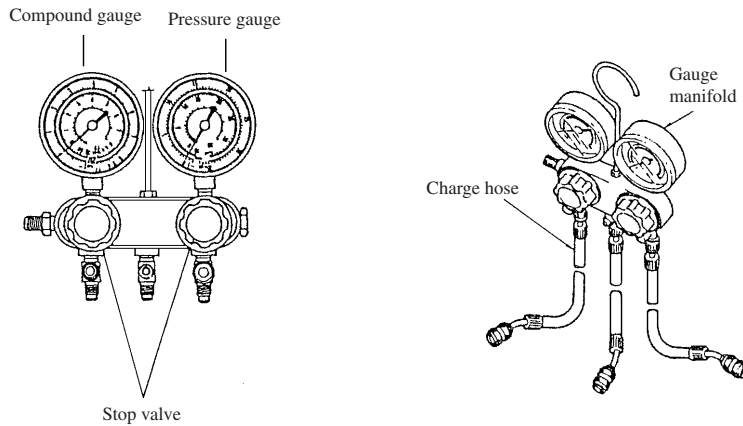

(5) Tube piercing valve

- A tool used to make a hole for recovery in the copper pipe when recovering R410A from equipment which has no port for charging or recovering gas. Various types are available on the market and given various names.
- As the piercing edge tends to wear, it is necessary to treat this valve as semi-expendables.
- As vacuum rises, air tends to be inhaled from the hole. So, care must be exercised.

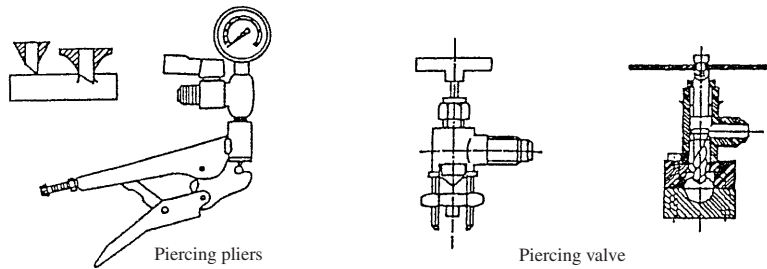

(6) Vacuum pump

Used to evacuate the recovering equipment and recovering cylinder.

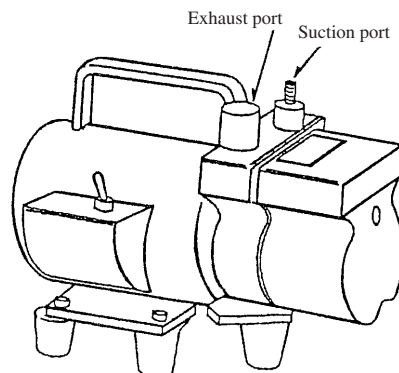

INVERTER WALL MOUNTED TYPE ROOM AIR-CONDITIONER



Air-Conditioning & Refrigeration Systems Headquarters
16-5, 2-chome, Kounan, Minato-ku, Tokyo, 108-8215, Japan
Fax : (03) 6716-5926