

***komfovent***<sup>®</sup>

# Ventilation equipment

CATALOGUE | 2019





***komfovent***<sup>®</sup>

VENTILATION EQUIPMENT



## DOMEKT

20

Residential ventilation units  
50 – 800 m<sup>3</sup>/h

<b>DOMEKT</b>	<b>22</b>
<b>Domekt R</b>	<b>24</b>
Domekt R 200 V	25
Domekt R 250 F	26
Domekt R 300 V	27
Domekt R 400 V	28
Domekt R 400 H	29
Domekt R 400 F	30
Domekt R 450 V	31
Domekt R 500 V	32
Domekt R 500 H	33
Domekt R 600 H	34
Domekt R 700 V	35
Domekt R 700 H	36
Domekt R 700 F	37
<b>Domekt CF</b>	<b>38</b>
Domekt CF 150 F/H <i>New unit</i>	39
Domekt CF 200 V <i>New unit</i>	40
Domekt CF 250 F	41
Domekt CF 300 V <i>New unit</i>	42
Domekt CF 400 V	43
Domekt CF 500 F	44
Domekt CF 700 V	45
Domekt CF 700 H	46
Domekt CF 700 F	47
<b>Domekt S</b>	<b>48</b>
Domekt S 650 F	49
Domekt S 800 F	50
Domekt S 1000 F	51



## VERSO

52

Commercial ventilation units  
800 – 40 000 m<sup>3</sup>/h

<b>VERSO Standard</b>	<b>55</b>
<b>VERSO R Standard</b>	<b>57</b>
Verso R 1000 U/H/V	58
Verso R 1300 U/H/V	59
Verso R 1300 F	60
Verso R 1500 U/H/V	61
Verso R 1700 U/H/V	62
Verso R 2000 U/H/V	63
Verso R 2000 F	64
Verso R 2500 H	65
Verso R 3000 U/H/V	66
Verso R 3000 F	67
Verso R 4000 U/H/V	68
Verso R 5000 V <i>New unit</i>	69
Verso R 5000 H	70
Verso R 7000 H	71
<b>VERSO CF Standard</b>	<b>72</b>
Verso CF 1000 U/H/V	73
Verso CF 1000 F	74
Verso CF 1300 U/H/V	75
Verso CF 1300 F	76
Verso CF 1500 F	77
Verso CF 1700 U/H/V	78
Verso CF 2300 U/H/V	79
Verso CF 2500 F	80
Verso CF 3500 U/H/V	81
<b>VERSO S Standard</b>	<b>82</b>
Verso S 1300 F	83
Verso S 2100 F	84
Verso S 3000 F	85

<b>VERSO Pro</b>	<b>86</b>
------------------	-----------





## RHP

94

Ventilation units with a rotary heat exchanger and an integrated heat pump  
150 – 25 000 m<sup>3</sup>/h

<b>RHP Standard</b>	<b>97</b>
RHP 400 V	98
RHP 600 U	100
RHP 800 U	102
RHP 1300 U	104
RHP 1500 U	106
<b>RHP Pro</b>	<b>108</b>



## KLASIK

110

Industrial/commercial ventilation units  
1000 – 100 000 m<sup>3</sup>/h

<b>KLASIK</b>	<b>112</b>
Klasik R	113
Klasik CF	113
Klasik P	113
Klasik S	113
Klasik Hg	114
Klasik Ra	115

# Why KOMFOVENT?



## High energy efficiency standards

All components and parts are accurately selected and assembled to achieve the best efficiency. An advanced control system optimizes the unit's performance.



## Silent operation and easy mounting

The units have tight, insulated and painted casing and high quality components, which ensures extremely silent operation and easy mounting.



## High efficiency PM fans

High efficiency PM (permanent magnet synchronous motors) fan motors use significantly less energy than AC (alternating current) motors. Automation communicates with PM motors through MODBUS protocol.



## Relevant rotary heat exchangers

Various types of rotary heat exchangers are available for the most efficient energy and humidity recovery. EC motors ensure minimum operating expenses and high performance.



## Connection possibilities

One of the main advantages of "U" series units is the multipurpose application of one unit – the unit can be connected to the ducts horizontally or vertically. An installer can always reverse the unit into the required version and choose the duct connection's position on site. One air handling unit – lots of connecting positions.



## Plug & Play solution

All units are completely prewired and have an integrated automatic control.



## Intelligent control

Smart controller algorithms provide a wide range of functional capabilities. The units can be controlled by control panel, via web browser and mobile devices or both. Due to the protocols implemented the units are easily integrated into any desired BMS.



## RHP solution

The integrated heat pump in RHP units extends the air handling unit's possibilities – the unit not only ventilates, but also heats or cools the premises. No need for condensing unit, easier installation, start-up and adjustment work.



## Eco-friendly and protected

R410A and R134A refrigerants are used in units with heat pumps.



## Laboratory tested units

Our units are tested not only in our laboratory but also in the independent testing centres in Germany and Switzerland.



## International quality approvals

Komfovent VERSO and KLASIK units are Eurovent certified, TÜV and RLT approved and conform to all required EU norms and regulations. Passive House Institute Certificate is also available for Domekt R 450 V unit.

## References

KOMFOVENT energy efficient air handling units are being exported to 30 countries.

The wide range of the units and their functionality allows you to apply the equipment in different types of projects: residential, public, hospitals, shopping malls, industrial buildings. Efficient performance and innovative automatic control corresponds to and may satisfy the most demanding requirements.



Metsäwood plywood production complex, Estonia.  
2 pct. x Klasik RA12; 5 pct. x VERSO; 3 pct. x DOMEKT.  
Total air flow 100 000 m<sup>3</sup>/h



NAUJOJI PILAITĖ, residential buildings, Lithuania.  
201 pct. x Domekt R 200 V.  
Total air flow 50 000 m<sup>3</sup>/h



MILLENNIUM CENTRE. Bulgaria.  
8 pct. x RHP Pro.  
Total air flow 59 000 m<sup>3</sup>/h

RIVER HALL. Lithuania.  
32 pct. x Verso R 2500.  
Total air flow 80 000 m<sup>3</sup>/h



## Wide range

### DOMEKT



**DOMEKT** – residential ventilation units with heat recovery. Depending on the individual requirement, a rotary or counterflow plate heat exchanger, vertical, horizontal or flat duct connections can be selected from a wide range of modifications.

Capacity	50 – 800 m <sup>3</sup> /h
Control system	C6 <b>SMART HOME</b>
Selection software	 <b>DOMEKT</b>

### VERSO

VERSO range consists of two groups:



- ✓ **VERSO Standard** – standardized air handling units with a rotary or counterflow plate heat exchanger, vertical, horizontal or flat duct connections and integrated control system C5.
- ✓ **VERSO Pro** – energy-saving modular units for commercial premises. This series offers a large number of configurations to meet the most demanding requirements. Integrated control system C5 ensures the optimal unit operation.

Capacity	800 – 40 000 m <sup>3</sup> /h
Control system	 <b>C5</b>
Selection software	 <b>VERSO</b>

### RHP



RHP range consists of two groups:

- ✓ **RHP Standard** – innovative units with heat pump and integrated control system C5 recovers the energy in two steps, and also maintains a comfortable indoor climate for residential and small commercial premises.
- ✓ **RHP Pro** – innovative units with rotary heat exchanger and integrated heat pump for commercial facilities. The highest level of comfort is provided in the premises – fresh air, efficient heating and conditioning, humidity control. Automation system C5 effectively controls all air parameters with maximum energy saving.

Capacity	150 – 25 000 m <sup>3</sup> /h
Control system	 <b>C5</b>
Selection software	 <b>VERSO</b>

### KLASIK

**KLASIK** – a series of the unique ventilation units for the most complex projects. The largest selection of heat exchangers, fans, heaters, coolers and humidifiers. Non-standard dimensions, hygiene versions, anti-corrosion coatings and other options.

Capacity	1000 – 100 000 m <sup>3</sup> /h
Control system	 <b>C5</b>
Selection software	 <b>KLASIK</b>



## Equipment by applications



## Modifications to standard products

### Heat exchanger

- **Rotary heat exchanger**

L/A – aluminum, condensing rotor – a standard for Domekt R and Verso R Standard units. The optimal efficiency and pressure loss ensures the shortest time to pay off the investment.

SL/A – aluminum, condensing rotor with increased surface and efficiency.

L/AZ – sorption rotary heat exchanger coated with special hygroscopic zeolite coating. The most effective control of humidity and the most comfortable indoor microclimate.

- **Counterflow plate heat exchanger**

Condensating – plate heat exchanger made of special polystyrene; there are no moving parts, which results in efficient heat exchange and long-term operation.

Enthaply – plate heat exchanger made of special membrane ensures the best heat and humidity recovery, also known to be hygienic and durable.

### Inspection side

Left or right inspection side is available for all units (see 128 p.).

### Duct connection

H – horizontal

V – vertical

U – universal, 14 installation options

F – false ceiling

### Heater

HE – electric heater.

HW – a water duct heater is installed on the duct and must be ordered separately. Heaters are mounted on the outside of the unit in any user-convenient place. 0...10 V heater control included in automatic control system.

HCW – heater-cooler one for both – heating and cooling. Ideal for buildings using geothermal energy.

### Cooler

CW – designed for air cooling using cold water (water-glycol mixture), provides a higher comfort level in rooms.

DX – designed for air cooling using direct expansion cooling unit, provides a higher comfort level in rooms.

# Energy-saving technologies



## 1 Efficient heat exchangers

### Rotary – condensing and sorption

Cold climates are ideal for rotary heat exchangers – they work efficiently both in winter and summer, do not ice even at extremely low temperatures, which saves you the most energy and is likely to pay off quickly. The sorption rotor provides better performance than a condensing rotor – better humidity control, higher comfort and greater energy savings for air conditioning.

### Plate – condensing and enthalpy

The plate heat exchangers are more appropriate for the warmer climates, because, when the outside air temperature is negative, the icing begins and that results in a loss of energy. Enthalpy heat exchangers are more efficient than condensing ones. Enthalpy, like rotary heat exchangers, humidify the air in the winter and dry it in summertime efficiently saving the energy.

### RHP double heat recovery – rotary heat exchanger and heat pump

The most efficient are RHP air handling units having double heat recovery and additional features: integrated heat pump efficiently heats the air in winter, while in summertime it cools the air like air conditioner.

## 2 Innovative control system

Preprogrammed operating modes and times allow the user to significantly reduce the energy consumption of the ventilation.

By controlling the ventilation intensity according to the CO<sub>2</sub> sensor signal, an optimal comfort level with minimal energy consumption is always maintained.

VAV – variable air function with additional sensors makes it possible to fully realize the function of "ventilation according to the need" – the ventilation intensity in each room is regulated according to a specific need, maximally saving energy.

## 3 Ultra and Super Premium fans

Highest energy efficiency *Ultra* and *Super Premium* class fan motors provide minimum power consumption.

Statically and dynamically balanced fans and their special design guarantee a quiet and harmonious operation of the unit.

Permanent magnets (PM) used in the fan motors create a powerful magnetic field, which greatly improves motor efficiency and reduces power consumption.

## Rotary heat exchangers

### Operating principle

The rotary heat exchanger transfer effect is based on the accumulation principle – the rotating aluminum wheel with small ducts is warmed up by extract indoor air and then the heat is transferred to the outdoor intake. At low temperatures, humidity from extract air condensates on the rotor surface and humidifies the outdoor intake air, where absolute humidity in winter is always too low to provide comfortable conditions. Therefore, such rotary heat exchangers are called condensing.

### Advantages

- Efficiently recovers the heat when the outside temperature drops to -30°C.
- No icing.
- Efficiently saves cold during the summer by reducing the cost of conditioning.
- Controls the humidity in the room while maintaining the optimal comfort level.
- Advanced design ensures minimal mixing of air flows.
- No drainage is necessary – easy unit installation.
- No primary heater as the heat exchanger does not ice.

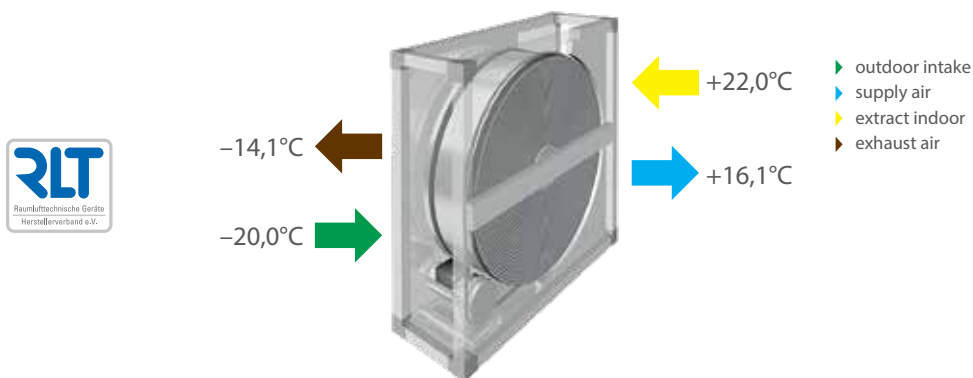

## Sorption rotary heat exchanger – the highest comfort

### Advanced energy saving technology

The latest improvements have been adapted in sorption rotary heat exchangers. The surface of the rotor has a zeolite coating, which improves the humidity exchange up to 90%, so this rotor effectively controls humidity – humidifies the supply air in the winter and dries it in the summer. The optimal comfort is maintained all year long, without the need for additional humidifiers and dehumidifiers.

### Advantages

- The shortest payback time.
- Lower investment in air conditioning equipment.
- Lower investment and operating costs for air humidification and dehumidification.
- More efficient use of passive cooling.

### Microclimate comfort zones of premises

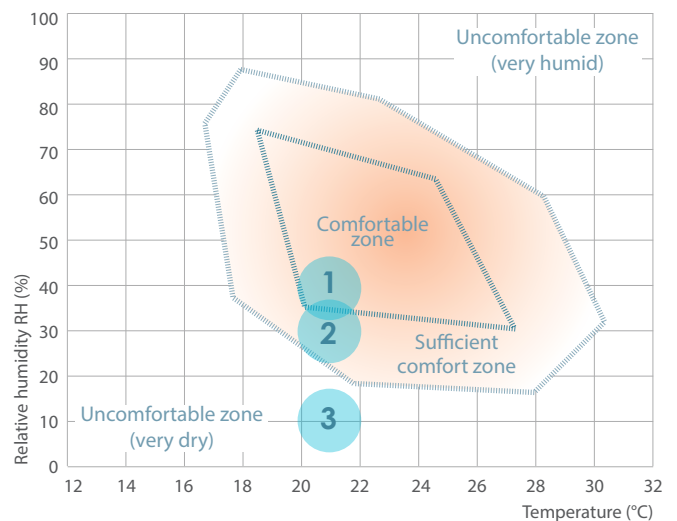

Parameters of equipment with different heat exchangers in winter:

- 1 Sorption rotary heat exchanger
- 2 Enthalpy counterflow plate heat exchanger
- 3 Counterflow plate heat exchanger

## Counterflow plate heat exchangers

### Operating principle

The plate heat exchangers are made of aluminum or plastic plates, which have gaps for air to flow. Fresh outdoor air and extract outdoor air flows in opposite directions through every second gap of the entire surface of the plates. Extract air transmits thermal energy to fresh outdoor air. Air flows do not mix. During winter, when the air is extracted from the room, the air cools in the heat and the humidity in it turns into ice, which makes plate heat exchangers more suitable for a medium and warm climate zone where there is no significant frost and no danger of icing. In cold weather, the automatic control system solves the problem of icing, but a loss of heat is lost, resulting in decreased seasonal efficiency and increased payback time.

### Advantages

- Thermal efficiency is up to 92%.
- Air flows do not mix.
- Effective performance and long service life is ensured by high-quality design.
- Perfect solution for premises with high humidity, as it effectively eliminates humidity in the cold seasons.
- Two types available: condensing or enthalpy.
- Quality approved by Eurovent, TÜV, DI and RLT.

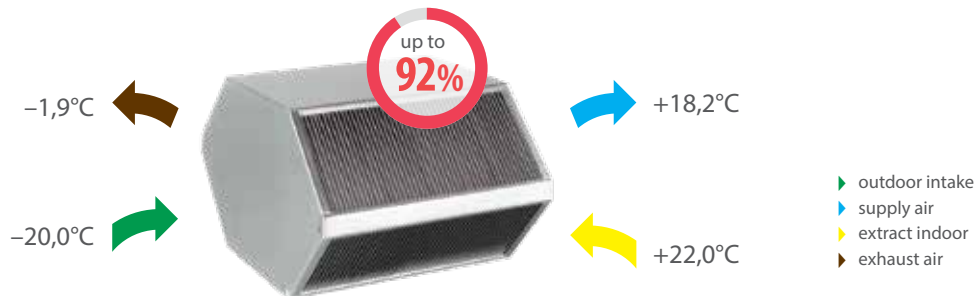

## Enthalpy heat exchanger – higher comfort

Due to the simple design and relatively low price cross flow plate heat exchangers dominated in the market for a long period of time. After tightening the requirements for efficiency, they were replaced by more efficient (and more expensive) counterflow plate heat exchangers, but with increased efficiency; the probability of the icing increased as well. Also, the problem is that in the winter the air is too dry.

In order to solve these problems, an enthalpy counterflow plate heat exchanger was developed. Its properties were close to the rotary heat exchanger – enthalpy can operate without freezing up to  $-15^{\circ}\text{C}$ , humidifies supplied air during the winter, and more efficiently saves the cold in the summer, as a result reducing the cost of conditioning.

### Patented membrane

Compared to cellulosic enthalpy heat exchangers, which have a limited life span, patented enthalpy heat exchanger manufactured from a special membrane achieves the best results in heat and humidity regeneration, moreover, the exchanger is very hygienic and durable.

### Operating principle

Outlet air humidity is recovered to inlet air through a special patented membrane, which does not allow outside dirt and bacteria to get into the premises.

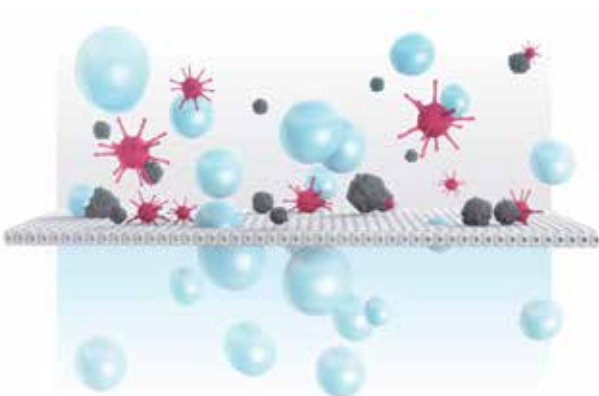



## RHP double heat recovery – triple the benefits

### Advanced Technologies

RHP ventilation unit is a complex solution that integrates all indoor microclimate support systems into one unit: ventilation, heating, air conditioning, air humidification and dehumidification, air quality and air filtering control. The latest and most advanced engineering and technological solutions developed and refined in the fields of heating, ventilation and air conditioning are included in these units.

- The sorption rotary heat exchanger not only effectively saves heat during the winter and cold in the summer, but also effectively controls the humidity in the rooms – during the winter, when it is too dry, the air is humidified, and in the summer – when it is too wet, the air is dried.
- The "heart" of the heat pump, an inverter constant current compressor with permanent magnets, complements and extends the capabilities of the air handling unit – during the transitional period, even when the outside air temperature drops to -15 ° C, it effectively heats up the supplied air and operates in the summer as the central air conditioner – the air is cooled down in all rooms.

- *Super Premium* and *Ultra Premium* performance class fans used in RHP units operate quietly and with minimal power consumption.
- Increased surface area filters clean fresh air supplied to the premises, resulting in no accumulation of dust in the premises.

### Advantages of the RHP solution

- Double recuperation – rotary heat exchanger + heat pump, returns 100% heat to the premises during winter.
- The heat pump works in the summer as an air conditioner.
- Unified automatic system controls all indoor microclimate processes – heating, cooling, humidifying, drying and air quality.
- Faster and easier installation and maintenance compared to individual heating, ventilation and air conditioning systems.
- No external blocks on the outside of the building.



### Operating principle

The ventilation unit with an integrated heat pump not only supplies fresh, cleaned air to the premises and eliminates impure air, but also heats, cools and humidifies the air. All processes are controlled by intelligent automation algorithms, and the premises maintain optimal microclimate with minimal energy use. The main energy-saving component – the rotary heat exchanger works efficiently

for almost the whole year, with the exception of the times when the outside and indoor temperatures are almost equal. With a higher temperature difference between outdoor and indoor air, a second recovery step starts and, depending on the demand, the air supplied is warmed up or cooled down to the set temperature.

#### Cooling mode

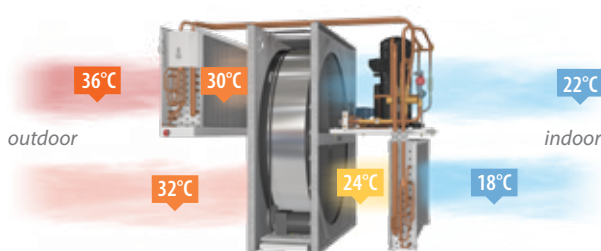

#### Heating mode

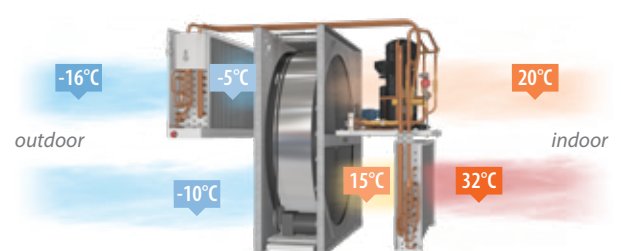

# KOMFOVENT selection software



✓ Simple and intuitive navigation

✓ Accurate and detailed unit information

✓ Wide range of modifications



## DOMEKT and RHP selection software

- For DOMEKT units with capacity from 50 to 800 m<sup>3</sup>/h.
- For RHP units with capacity from 150 to 1000 m<sup>3</sup>/h.
- Parameters are calculated for specific climate and operating conditions.
- Selection of units accessories.
- Comparison of the units.





## VERSO and RHP selection software

- For VERSO units with capacity from 800 to 40 000 m<sup>3</sup>/h.
- For RHP units with capacity from 1000 to 25 000 m<sup>3</sup>/h.
- Eurovent, TUV and RLT certificates guarantee the accuracy of the parameters.
- Detailed technical data report.
- Generating VERSO Pro 3D models for the REVIT program.
- Integrated VERSO Standard 3D models library – KOMFOVENT HUB.



## Komfovent VERSO + REVIT

Advanced, precise and fast integration of ventilation equipment into digital building projects (BIM).

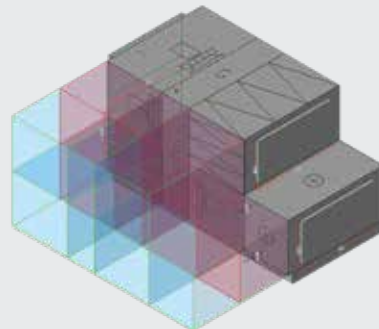
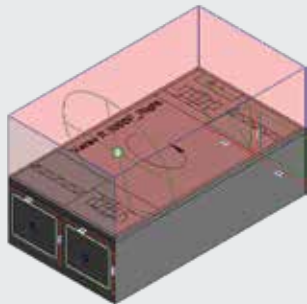

Komfovent HUB – VERSO Standard digital drawings library for REVIT users.

REVIT models of Komfovent VERSO Pro equipment are generated individually for each project.



## KLASIK selection software

- For units from 1000 to 100 000 m<sup>3</sup>/h.
- Solutions to the most complex projects.
- Wide range of modifications.
- Eurovent, TÜV, RLT certified.

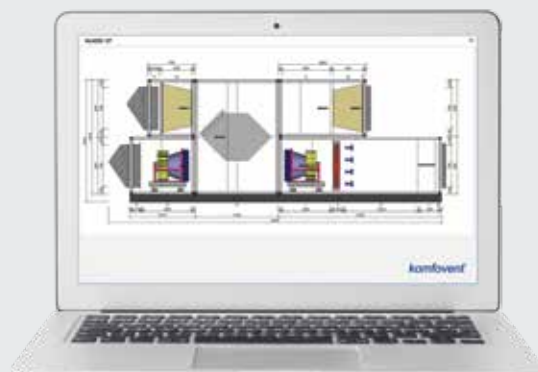

# KOMFOVENT control systems

## C5 and C6



### C5

Control system C5 – designed for professionals, controls thermodynamic processes and saves energy.

The user is given detailed information about the operation of the device. A variety of modes and functions allows you to choose the most optimal operating mode that maximizes energy saving. For user convenience, the operation of the air handling units can be controlled not only by the control panel, but also via the Internet or BMS.

### C6

Smart control system C6 – designed for end users, has wide control possibilities and simple navigation.

Core philosophy behind the design of C6 was so that the ventilation unit would operate properly without constant adjustments from the user. Different ventilation modes are optimized for the user's daily needs. The user-friendly interface allows you to intuitively control the air handling unit.



### Extensive control options

Smart controller algorithms provide a wide range of control capabilities that ensure maximum energy savings while maintaining a high level of comfort in ventilated areas: air quality control, performance on demand, summer night cooling, VAV, CAV and many more.



### User-friendly control

Controllers are easily and conveniently controlled. The user can monitor the operation parameters and change the settings in one or several ways convenient for him: using a control panel that has a touch-sensitive LED display, a mobile application, or a web server.



### "Plug and Play"

KOMFOVENT ventilation units are designed using the "Plug and Play" principle. No external control boxes and no additional wiring are needed – the unit is fully prepared for use at the factory – that saves customers time, energy and money.



### Integrated, specially designed automation

Fully integrated automatic control KOMFOVENT ensures the safe and reliable operation of air handling units, controls the system settings and optimizes the operating costs of the unit.



### Integration to BMS

All KOMFOVENT air handling units have fully implemented *Modbus* and *BACnet* protocols, which allows seamless integration with any desired Building Management Systems.



### Quality and guarantee

Everything is installed and tested at the factory. Each unit produced passes a two-stage quality control. Firstly, it is checked in production, secondly, even more thorough, the parameters are checked and a performance check carried out before it is sent to the customer. Therefore, the customer can be sure that the device and its control system are properly synchronized and ready for operation.

# KOMFOVENT control system offers wide control options

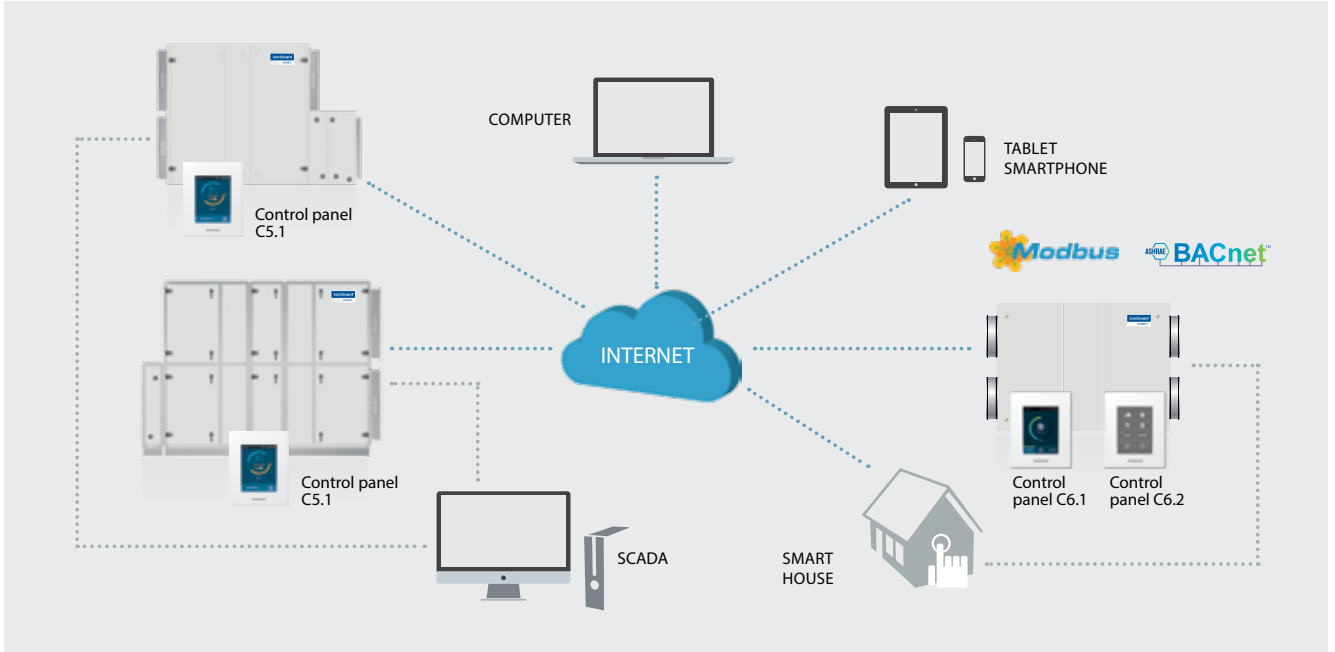

Scan the QR codes below and download mobile applications:

KOMFOVENT units has integrated web server for controlling and monitoring the units' operation via the Internet.

Smartphone applications are specially developed for more convenient control. A user-friendly interface enables clear and easy air handling unit control.

Implemented Modbus and BACnet protocols allow easy integration of KOMFOVENT air handling units to any desired Building Management Systems. A large number of units can be connected into a single building monitoring and control system.



"Komfovent" application for units with integrated C5 control system.

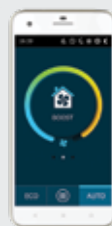

"Komfovent Home" application for units with integrated C6 control system.



## Analysis tool for units operation "LogPlotter"

The computer program "Komfovent LogPlotter" has been designed to analyze the unit's operation history over the last 7 days. Unit's operation with C5 can be monitored not only in real-time from now on. The program is for service and maintenance staff.





# C6 SMART HOME

## Smart control system C6 for DOMEKT units

### Panel C6.1

- Indication of parameters
- Setting of all parameters from the panel
- Colored touch-sensitive LED display



Integrated webserver

Modern design

Factory preset parameters

### Panel C6.2

- Simple control
- Touch-sensitive screen
- Operation modes



**✓ Updated controller – C6M\***

**More accurate temperature maintenance**

Modulated heat exchanger control allows you to maintain the desired temperature more accurately. Updating reduces the power consumption of the unit.

**New application**

Remote control in two steps: connect the unit to the Internet, scan the controller's QR code – and the unit will automatically connect to the KOMFOVENT Cloud server.

**"Plug and Play"**

All temperature sensors are integrated into the unit, making installation and maintenance easier.

**Measurement of air flow in real time**

The new sensors measure airflow in real time, and therefore automatic system accurately maintains the specified performance and adjusts the airflow balance independently of changing conditions.

\* Implementation will be gradual and by 2020 all DOMEKT units will be equipped with the C6M controller.

### For both: beginners and advanced users

A user-friendly interface enables intuitive navigation and control of the unit. Core philosophy behind the design of C6 was so that the ventilation unit would operate properly without constant adjustments from the user. Different ventilation modes are optimized for the user's daily needs. Automatic air quality control selects the most appropriate mode and ensures the comfort conditions in the room. Advanced users can control unit's operation according to his needs, as many settings and control possibilities are provided as well:

- Airflow control: CAV / VAV / DCV.
- Intensity control by air quality, CO<sub>2</sub>, humidity level.

### Energy counters

- Real-time energy consumption indicator.
- Possibility of observing the running costs of ventilation unit.
- Heat recovery counter.

### Control options

- Possibility to choose from two control panels.
- Control via web browser / smartphone.
- Ability to control via BMS (Modbus, BACnet).

### Operating modes

- 8 preset modes.
- Intelligent energy saving algorithms.
- Automatic air quality control with optional AQ sensor.
- Extensive weekly schedule.



**SMART CONTROL FUNCTIONS**

**Supply air temperature control**

The unit supply a user-defined temperature air

**Extract air temperature control**

The unit automatically delivers air at a temperature so that the set temperature of the exhaust air is maintained

**Room air temperature control**

The unit supports the user-set ambient room temperature, according to the temperature sensor located in the panel

**Temperature balance control**

The temperature support value of the supply air is automatically set on the basis of the current extract air temperature, i.e. the extract air temperature and the supply air temperature will be the same

**Constant air volume control (CAV)**

The unit supplies and extracts a constant air volume as set by the user, regardless of changes in the ventilation system

**Variable air volume control (VAV)\***

The unit supplies and extracts air volume correspondingly to the ventilation requirements in different premises

**Directly controlled volume (DCV)**

The air volumes are controlled by direct external control signals

**External water coil control**

There is estimated an additional water duct heater or cooler control that can be activated by the user on the control panel

**External DX unit control**

There is estimated an additional external direct expansion (DX) unit control that can be activated by the user on the control panel

**Weekly operation schedule**

It is possible to choose one of the four pre-set weekly operation schedules. If necessary, the schedule can be modified

**Holidays planning**

The user can set the holiday dates for period when he is away. Then the unit will not operate for most of the time, but ventilate the premises occasionally

**Air quality control\***

Upon connecting the external air quality/humidity sensors, the ventilation intensity is chosen automatically. In this way, the maximum room comfort is ensured with the minimum energy cost

**Operation on demand\***

The ventilation unit will operate when the air quality in the premises exceeds the set levels

**Cool recovery**

During the summer season, in the conditioned premises cool from extract air is returned back into the premises

**Temperature saving function**

The automatic function attempts to maintain comfortable temperature conditions in the premises by reducing the ventilation intensity, i.e. it prevents excessive cooling down or overheating of the premises

**Free cooling**

When the room temperature air exceeds the set value, and the outdoor temperature is lower than the room temperature, the heat recovery and the other heating/cooling processes is blocked automatically and freecooling are performed only by fans

**Ventilation control by external contacts**

Air flow can be controlled by three external contacts, each of which can be assigned to different ventilation intensity

**Control via internet browser**

When the device is connected to the computer network or the Internet, the user-friendly web interface allows the operator to control the equipment with a computer or with another mobile device

**Control with smartphones**

The "Komfovent Home" mobile app has the same interface as the control panel and allows the user to control the ventilation unit from any point

**SAFETY FUNCTIONS**

**Filter clogging indication**

Clogging of the air filters is measured depending on the duration and intensity of the unit's operation. The user is informed by a message, when it is time to change air filters

**Water mixing system warming-up**

For units with additional external water heaters/coolers, the circulation pump and mixing valve motion system is provided

**Rotor warm-up and cleaning function**

In order to prevent the eventual contamination of the stopped rotary heat exchanger, the unit has a periodical forced activation

**Heat exchanger frost protection**

Units with a counter-flow plate heat exchanger have a primary elected heater that is controlled as needed, and is operated only at the capacity to ensure frost protection. In this way, the ventilation unit can operate in low outside temperatures

**Heat exchanger failure indication**

In units with plate or rotary heat exchanger, a control system monitors the thermal efficiency, and if it does not reach the stated level, a fault is indicated

**Water heater frost protection**

This ensures the maximum reduction of the possibility of water freezing during the unit's operation. When the unit is switched off, warm water circulation is supported

**Electric heater overheat protection**

If there is danger of overheating, heater shuts down automatically. When unit is shut down during the heating operation, fans will continue to operate for set time period

**Low air flow indication**

If the ventilation unit does not reach the set air volume during the specified time, the unit's operation is stopped

**Emergency shut down in case of fire**

The external fire alarm is provided when the unit is connected to the building fire alarm system. There is also an internal fire alarm to detect an increased temperature inside the air handling unit or the ventilation system

**Emergency shut down when temperature reaches critical limits**

When the supply air temperature drops below or exceeds the permitted value, the unit is stopped

**Intelligent self-diagnostic**

Self-check function of controller and elements of the air handling unit. If a fault is detected, controller terminates the operation of the unit and warns about such a fault using the respective informative messages

\* these functions require additional accessories.

# Control system C5 for VERSO, RHP and KLASIK units

Panel C5.1



Extremely thin – only 12 mm

3 ways of fixing the panel

Integrated thermometer and hygrometer

Colour touch-sensitive LED display

Smart control of parameters

## Detailed information for the user

- Air flow indication (m<sup>3</sup>/h, m<sup>3</sup>/s, l/s).
- Thermal efficiency of the heat exchanger (%).
- Heat exchanger energy recovery (kW).
- Thermal energy savings indicator (%).
- Air heater energy consumption (kWh).
- Heat exchanger recovered energy counter (kWh).
- Fan's energy consumption (kWh).
- SFP factor of the fans\*.
- Clogging level of filters (%).

## Various operating modes

- 5 different operation modes: *Comfort1*, *Comfort2*, *Economy1*, *Economy2*, and *Special*. User may set supply and extract air volumes as well as air temperature for each of mode separately.
- Temperature control modes: Supply air / Extract air / Room / Balance. Possibility to select which temperature to maintain.
- Flow control modes: Constant Air Volume (CAV), Variable Air Volume (VAV), Directly Controlled Volume (DCV).
- Universal operating schedule with up to 20 events, for which of them the user can assign weekday(s) and one of five operating modes.
- Holliday scheduling allows the user to change operating mode or switch off the air handling unit on some dates of the year. Up to 10 events are possible.

\* only with PM fans

## Extended control possibilities

- Controlling up to 30 units connected into a network from one panel.
- Ability to connect the controller to the Internet network and manage it via a standard internet browser without any accessories.
- Possibility to control air handling unit by Smartphone via Android OS or iOS application software.
- Ability to control the unit not only by a control panel or a computer, but also by different external devices (switch, timer, etc.) and systems (e.g. the smart house system).

## Connectivity & Protocols

- Modbus RTU over RS-485
- Modbus TCP over Ethernet
- BACnet/IP over Ethernet





## CONTROL FUNCTIONS

### Air quality control

Two different air quality values may be set for two different unit operating modes (e.g. *Comfort* and *Economy*). These values will be maintained by automatically increasing or reducing the intensity of ventilation

### Outdoor compensated ventilation

This function adjusts the air volume depending on the outdoor temperature. It is possible to enter four temperature points where two of them define winter conditions and the other two define summer conditions. Upon entering the compensation curve according to the outdoor temperature, the current intensity of ventilation is decreased or increased accordingly

### Summer night cooling

This function is intended for energy saving in summer: utilising the outside chill of night hours to cool down the heated rooms. The user may enable or disable function at any time as well as set the room temperature at which the function is automatically activated

### Override function

Override control of the unit can be performed by an external device (timer, switch, thermostat, etc.). The signal received from the outside activates the function which switches the unit to the pre-programmed mode ignoring the current operating mode

### Minimum temperature control

This function forces the reduction of the supply and extract air volumes set by the user when the heater capacity available in the unit is insufficient and/or heat recovery does not ensure the supply of the minimum temperature to the room

### Operation on demand

The air handling unit start-up function is designed to start the unit operating in off mode when one of the selected parameters (CO<sub>2</sub>, air quality, humidity, or temperature) has exceeded the critical limit

### Humidity control

An air handling unit can be ordered with an air humidity control function. If this function is available the user is able to choose the humidity control location: supply air, extract air or room. The user is also able to choose the method of control: humidification, dehumidification or both at a time

### Circulation pumps control on demand

Both heating and cooling pumps are controlled according to the current need for heating or cooling instead of a season control

### Air flow density compensation

Air density depends on the temperature. The controller has a function which adjusts the air flows automatically to avoid any imbalance in rooms while being ventilated

### Change-over function

Control of combined water heater cooler and DX cooler reversing to the heating mode

### Additional zone control

Option for independently control of additional heaters and coolers in separately ventilated area. Up to two additional temperature zones can be controlled

### Recirculation control

The controller has a modulated extract air recirculation function. There are four control options: 1) recirculation according to the air quality which may be defined by one of the selected parameters: CO<sub>2</sub>, air pollution by organic components and chemical substances, humidity or temperature; 2) recirculation according to the external temperature curve; 3) recirculation according to a weekly schedule; 4) recirculation controlled by an external device

### Recirculation limitation by temperature

Recirculation may be limited according to the need for heating or cooling. In cases where recirculation is controlled automatically according to one of the air quality sensors or the recirculation level set by the user, the required value of extract air recirculation may be ignored if recirculation heats or cools down the supplied air too much. In such a case recirculation is forcibly reduced until the temperature of supply air set by the user has been reached

## SAFETY FUNCTIONS

### Rotary or plate heat exchanger failure protection

This function observes the thermal efficiency of the heat exchanger. If it does not reach the required level a fault is recorded and indicated

### Rotary or plate heat exchanger anti-frost

Under the low outdoor temperature conditions, this function is constantly observing decreasing tendency of the heat exchanger thermal efficiency, determines the moment when the heat exchanger starts freezing, and activates the defrosting function automatically

### Service time

A warning message appears when the continuous operation of the AHU has reached 12 months

### Rotor warm-up function

This function forcibly activates the rotary heat exchanger if the air handling unit is turned off for some time and the temperature inside the unit or ventilation system is low enough for the rotor to freeze

### Circulation pumps start-up in off mode

This function starts water circulation pumps for a short period of time when they are off longer than the set period

### Warning for too low air flow

If the air handling unit does not reach the air volume set within the time set, the user is warned by an informative message

### External stop

Shut-down function from external device. May be used with or without an automatic unit restart

### Emergency shut-down in case of fire

The external fire alarm is provided when the unit is connected to the building fire alarm system. There is also an internal fire alarm to detect an increased temperature inside the air handling unit or the ventilation system

### Intelligent self-diagnostic

Self-check function of controller and elements of the air handling unit. If a fault is detected, controller terminates the operation of the unit and warns about such a fault using the respective informative messages

# DOMEKT

Residential ventilation units



50 – 800 m<sup>3</sup>/h



### Energy recovery

DOMEKT series are equipped with only the most efficient EC (electronically commutated) fans, high efficiency rotary and counterflow plate heat exchangers, filters with a huge filtering area and intelligent automation C6. All these components dramatically reduce energy consumption while maintaining a comfortable indoor climate.

### Wide range

Depending on your installation plans, you can choose the most appropriate model: horizontal, vertical or fat. Non-freezing rotary or high efficiency counterflow plate heat exchangers are available. All units are equipped with electrical heaters. Water heater is available as an option. Detailed information on all units can be found in the DOMEKT selection software.

### New casing technology EPP

The latest manufacturing technologies are applied to the following DOMEKT units: R 300 V, CF 150 F, CF 200 V, CF 300 V. The casing is produced from a special thermo-insulating sound absorbing material, which not only improves the casing's technical characteristics, but also enables more automatic processes of production.

The advantages of units produced using EPP (expanded polypropylene) technology:

- No thermal bridges, no condensation;
- Improved thermal insulation;
- Better aerodynamics;
- Better tightness;
- Reduced weight;
- Hydrophobic.



### Integrated smart control system C6

Core philosophy behind the design of C6 was so the ventilation unit would operate properly without constant adjustments from the user. Factory predefined settings – simply "Plug and Play".

### Remote control

The units can be controlled not only with the control panel, but also remotely via a web browser on your computer or mobile devices. The "Komfovent Home" application was specially developed for more convenient control.

### Integration to BMS

All KOMFOVENT air handling units have fully implemented Modbus and BACnet protocols, which allows seamless integration with any desired Building Management Systems.

### Low noise level

Only perfectly balanced fans with unique geometry are used in DOMEKT units. All of the unit's components are aerodynamically matched. Housings padded with mineral wool and the use of special composite materials ensure silent operation of these units.

### Reliability and durability

Double protection from corrosion – the housing of the units is made of galvanized steel with a powder coated finish. Fan motors are protected from humidity and dust, and equipped with long-life bearings.

# DOMEKT

## Range review

### Domekt R



Sizes and capacities of Domekt R units

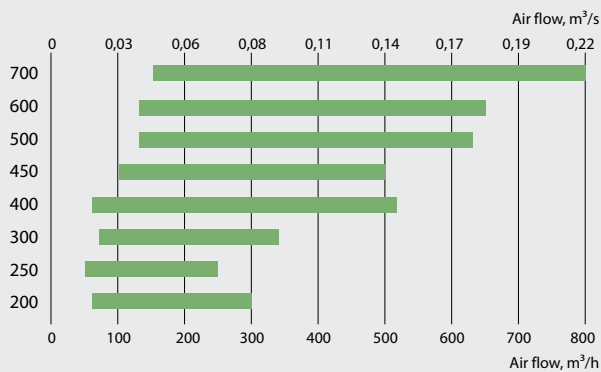

### Domekt CF



Sizes and capacities of Domekt CF units

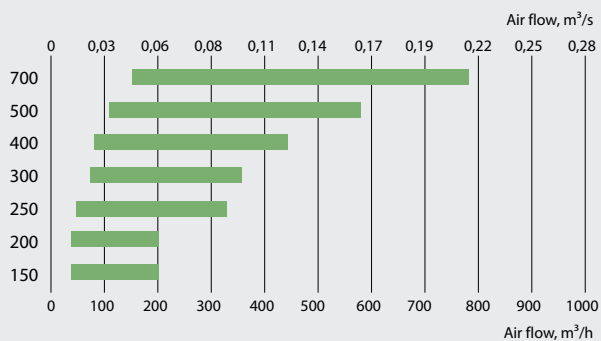

### Domekt S

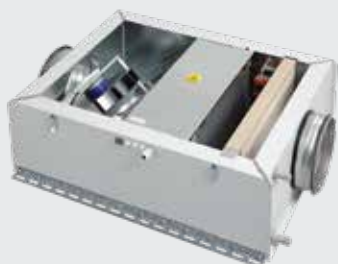

Sizes and capacities of Domekt S units

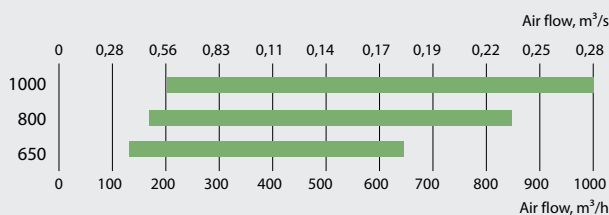

## Advantages of the units

### Efficient heat exchanger

Under the normal operating conditions, the rotary heat exchanger does not freeze: even at outdoor temperatures below -20 °C, no additional warming up of the outdoor air required. Also, the rotary heat exchanger effectively saves the cold during the summer, significantly reducing the cost of air conditioning.

### Low noise level

Silently operating fans and sound insulation ensures low noise level.

### Air humidity balance

Under normal operating conditions, condensation does not form in the rotary heat exchanger during the process of heat exchange, because most of the humidity is returned to the premises. Excess humidity is removed outside. The air in the premises is less dry and the air humidity balance is maintained during cold periods. As condensation does not form, drainage is not necessary – this simplifies the mounting of the unit.

### Energy efficient EC rotor motor

Rotary heat exchangers are equipped with EC motors, which ensure the smooth rotor operation and control.

### Enthalpy energy saving

As option it is possible to order units with enthalpic counter flow plate heat exchanger which recovers heat or cold and also controls humidity in premises during winter time.

### Heat energy saving and dehumidification

The counter flow plate heat exchanger maintains high efficiency when outdoor air temperature is above -4°C. The humidity in the air of the room is condensed, so this heat exchanger is most suitable for high humidity rooms.

### Long-term efficient operation

Counterflow plate heat exchangers are made of special polystyrene. The absence of movable parts ensures effective heat exchange and longevity.

### Totally separated air flows

The supply and exhaust air flows are separated, thus making it possible to utilize the heat of the extracted foul air.

### Low noise level

Silently operating fans and sound insulation ensures low noise level.

- Height is only 297 mm / 350 mm – easy to choose the place for installation.
- Units are complemented with fastening profiles and vibration-absorbing holders.
- Safe and handy design of removable cover ensures easy fixing of cover at different opening levels to carry out maintenance and service inspection.

- Air handling units have integrated control system.
- Control panel may be installed in any user-convenient place.
- Control panel display enables setting the operation parameters of the unit and monitoring them.
- There is a possibility to complement and control the duct mounted cooling section.

# Domekt R

## Air handling units with rotary heat exchanger

### Sizes and capacities of Domekt R units

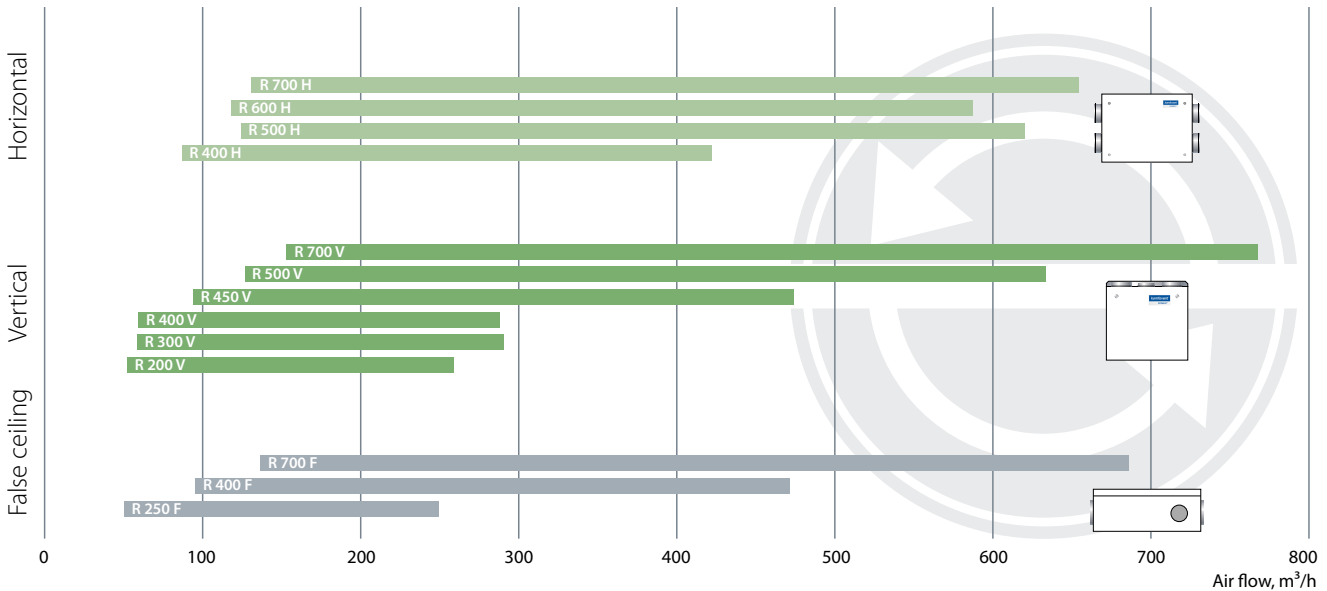

### Modifications of Domekt R units

Unit	Heat exchanger		Supply/exhaust air filter class		Heater			Cooler		Inspection side				Control system / panel		
	L/A	L/AZ	F7	M5	HE	HW	HCW	CW	DX	R1	R2	L1	L2	C4 C4.1	C6 C6.1 C6.2	
Domekt R 200 V	●		○	●	●	△	△			○		○		●		
Domekt R 250 F	●	○	○	●	●	△	△	△	△	○	○	○	○		○	○
Domekt R 300 V	●	○	○	●	●	△	△	△	△	○		○			○	○
Domekt R 400 V	●	○	○	●	●	△	△	△	△	○		○			○	○
Domekt R 400 H	●	○	○	●	●	△	△	△	△	○		○			○	○
Domekt R 400 F	●	○	○	●	●	△	△	△	△	○	○	○	○		○	○
Domekt R 450 V	●	○	○	●	●	△	△	△	△	○		○			○	○
Domekt R 500 V/H	●	○	○	●	●	△	△	△	△	○		○			○	○
Domekt R 600 H	●	○	○	●	●	△	△	△	△	○		○			○	○
Domekt R 700 V	●	○	○	●	●	△	△	△	△	○		○			○	○
Domekt R 700 H	●	○	○	●	●	△	△	△	△	○		○			○	○
Domekt R 700 F	●	○	○	●	●	△	△	△	△	○	○	○	○		○	○

● standard equipment    ○ possible choice    △ ordered separately duct heater/cooler

The markings are explained on p. 7.

# Domekt R 200 V

Maximal air flow, m <sup>3</sup> /h	258
Panel thickness, mm	25
Unit weight, kg	42
Supply voltage, V	1~230
Maximal operating current, A	HE4,7
Thermal efficiency of heat recovery, %	82
Reference flow rate, m <sup>3</sup> /s	0,05
Reference pressure difference, Pa	50
SPI, W/(m <sup>3</sup> /h)	0,35
Filters dimensions BxHxL, mm	285x130x46
Electric power input of the fan drive at reference flow rate, W	27
Electric power input of the fan drive at maximum flow rate, W	66
Electric air heater capacity, kW / Δt, °C	0,8 / 12,3
Control panel	C4.1
Maintenance space, mm	300



The photo is intended for informational purposes only. exact details may vary.



### Acoustic data

**A-weighted sound power level L<sub>WA</sub>, dB(A) at reference flow rate**

Supply inlet	53
Supply outlet	66
Exhaust inlet	53
Exhaust outlet	66
Casing	43

**A-weighted sound pressure level L<sub>PA</sub>, dB(A) 10 m<sup>2</sup> normally isolated room, distance from casing – 3 m.**

Surroundings	33
--------------	----

### Temperature efficiency

Outside temperature, °C	Winter				
	-23	-15	-10	-5	0
After heat exchanger, °C	11,6	13,5	14,6	15,8	16,9

indoor +22°C, 20 % RH

Shown as left (L1)

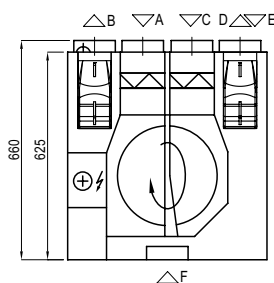

Shown as right (R1)

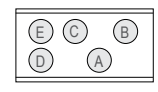
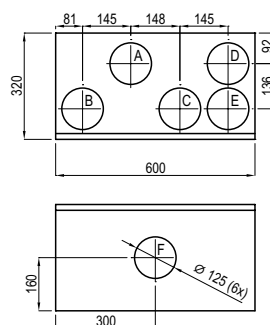

- A outdoor intake
- B supply air
- C extract indoor
- D exhaust air
- E additional extraction connection (by-pass – extraction without heat recovery)
- F kitchen hood connection (by-pass – extraction without heat recovery)

### Performance

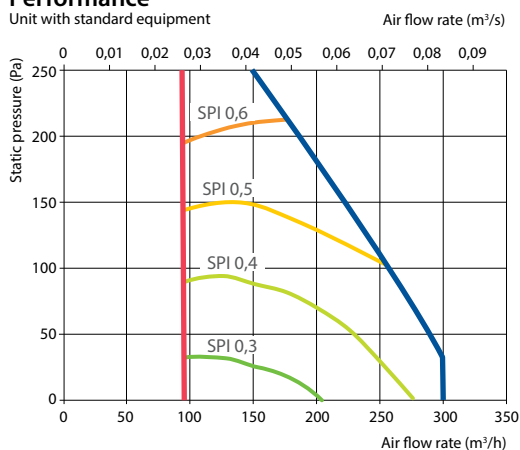

### Accessories (p. 120)

Closing damper	AGUJ-M-125+LF230/LM230
Silencer	A/D AGS-125-50-600-M
	B/C AGS-125-50-900-M
Water heater	DH-125
PPU	PPU-HW-3R-15-0,4-W1
2-way valve (water heater)	VVP47.10-0,4

Water cooler	DHCW-125
2-way valve (water cooler)	VVP47.10-1,6
Kitchen hood	KH
Decorative panel	DP
Air distribution box	OSD-200 VE-125
Outdoor grill	LD-125



# Domekt R 250 F

Maximal air flow, m <sup>3</sup> /h	250
Panel thickness, mm	50
Unit weight, kg	40
Supply voltage, V	1~230
Maximal operating current, A	HE 6,1
Thermal efficiency of heat recovery, %	80
Reference flow rate, m <sup>3</sup> /s	0,049
Reference pressure difference, Pa	50
SPI, W/(m <sup>3</sup> /h)	0,47
Filters dimensions B×H×L, mm	278×258×46
Electric power input of the fan drive at reference flow rate, W	40
Electric power input of the fan drive at maximum flow rate, W	90
Electric air heater capacity, kW / Δt, °C	1/15,9
Control panel	C6.1 / C6.2
Maintenance space, mm	300

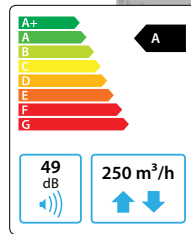

The photo is intended for informational purposes only. exact details may vary.



C6.1



C6.2

## Acoustic data

A-weighted sound power level  $L_{WA}$ , dB(A) at reference flow rate

Supply inlet	61
Supply outlet	70
Exhaust inlet	61
Exhaust outlet	70
Casing	49

A-weighted sound pressure level  $L_{pA}$ , dB(A)

10 m<sup>2</sup> normally isolated room, distance from casing – 3 m.

Surroundings	38
--------------	----

## Temperature efficiency

Outside temperature, °C	Winter					Summer		
	-23	-15	-10	-5	0	25	30	35
After heat exchanger, °C	10,7	12,7	14,0	15,2	16,5	22,8	24,0	25,3

indoor +22°C, 20 % RH

Shown as right (R2)

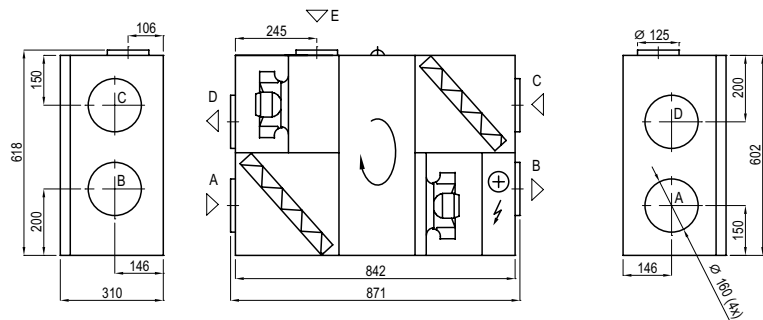

Shown as left (L2)

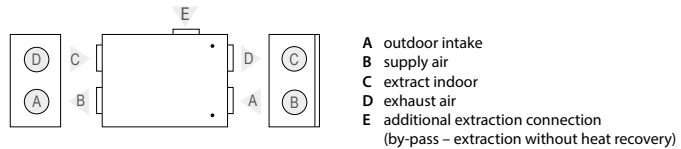

## Performance

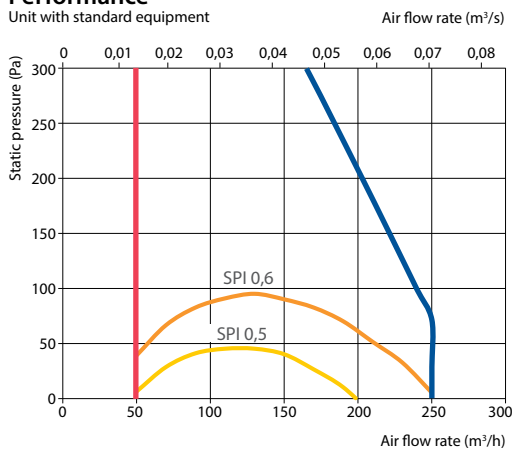

## Accessories (p. 120)

Closing damper	AGUJ-M-160+LF230/LM230
	A/D AGS-160-50-600-M
Silencer	B/C AGS-160-50-900-M
Water heater	DH-160
PPU	PPU-HW-3R-15-0,4-W1

2-way valve (water heater)	VVP47.10-0,4
Water cooler	DCW-0,2-1 / DHCW-160
2-way valve (water cooler)	VVP47.10-1,6
DX cooler	DCF-0,2-1



# Domekt R 300 V

Maximal air flow, m <sup>3</sup> /h	289
Panel thickness, mm	30
Unit weight, kg	28
Supply voltage, V	1~230
Maximal operating current, A	HE4
Thermal efficiency of heat recovery, %	84
Reference flow rate, m <sup>3</sup> /s	0,056
Reference pressure difference, Pa	50
SPI, W/(m <sup>3</sup> /h)	0,27
Filters dimensions BxHxL, mm	290x205x46
Electric power input of the fan drive at reference flow rate, W	27
Electric power input of the fan drive at maximum flow rate, W	72
Electric air heater capacity, kW / Δt, °C	0,5/6,9
Control panel	C6.1 / C6.2
Maintenance space, mm	450

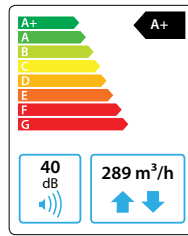

The photo is intended for informational purposes only. exact details may vary.



C6.1



C6.2

## Acoustic data

A-weighted sound power level  $L_{WA}$ , dB(A)  
at reference flow rate

Supply inlet	52
Supply outlet	60
Exhaust inlet	52
Exhaust outlet	60
Casing	40

A-weighted sound pressure level  $L_{PA}$ , dB(A)

10 m<sup>2</sup> normally isolated room, distance from casing – 3 m.

Surroundings	30
--------------	----

## Performance

Unit with standard equipment

Air flow rate (m<sup>3</sup>/s)

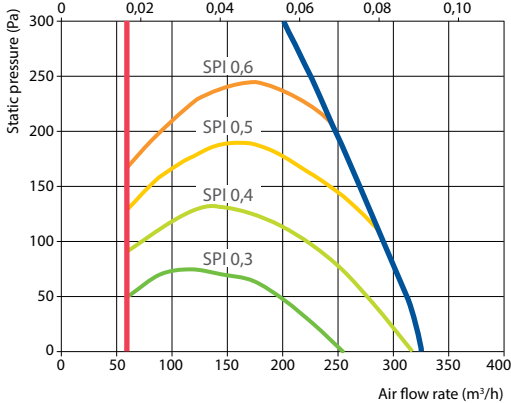

## Temperature efficiency

Outside temperature, °C	Winter					Summer		
	-23	-15	-10	-5	0	25	30	35
After heat exchanger, °C	14,7	16,0	16,8	17,6	18,4	22,5	23,3	24,1

indoor +22°C, 20 % RH

Shown as left (L1)

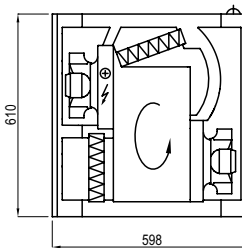

Shown as right (R1)

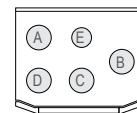

- A outdoor intake
- B supply air
- C extract indoor
- D exhaust air
- E additional extraction connection (by-pass – extraction without heat recovery)

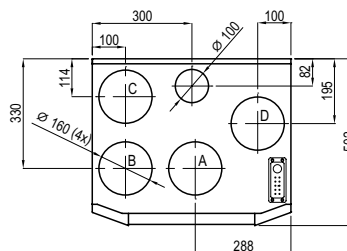

## Accessories (p. 120)

Closing damper	AGUJ-M-160+LF230/LM230
	A/D AGS-160-50-600-M
Silencer	B/C AGS-160-50-900-M
Water heater	DH-160
PPU	PPU-HW-3R-15-0,4-W1

2-way valve (water heater)	VVP47.10-0,4
Water cooler	DCW-0,4-3 / DHCW-160
2-way valve (water cooler)	VVP47.10-1,6
DX cooler	DCF-0,4-3

# Domekt R 400 V

Maximal air flow, m <sup>3</sup> /h	287
Panel thickness, mm	25
Unit weight, kg	50
Supply voltage, V	1~230
Maximal operating current, A	HE5,5
Thermal efficiency of heat recovery, %	86
Reference flow rate, m <sup>3</sup> /s	0,056
Reference pressure difference, Pa	50
SPI, W/(m <sup>3</sup> /h)	0,24
Filters dimensions B×H×L, mm	450×210×46
Electric power input of the fan drive at reference flow rate, W	23
Electric power input of the fan drive at maximum flow rate, W	71
Electric air heater capacity, kW / Δt, °C	1 / 13,8
Control panel	C6.1 / C6.2
Maintenance space, mm	450

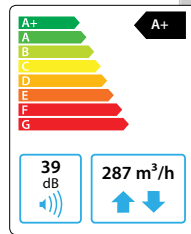

The photo is intended for informational purposes only. exact details may vary.



## Acoustic data

A-weighted sound power level  $L_{WA}$ , dB(A)  
at reference flow rate

Supply inlet	52
Supply outlet	65
Exhaust inlet	52
Exhaust outlet	65
Casing	39

A-weighted sound pressure level  $L_{pA}$ , dB(A)

10 m<sup>2</sup> normally isolated room, distance from casing – 3 m.

Surroundings	29
--------------	----

## Temperature efficiency

Outside temperature, °C	Winter					Summer		
	-23	-15	-10	-5	0	25	30	35
After heat exchanger, °C	14,8	16,1	16,9	17,7	18,5	22,5	23,3	24,1

indoor +22°C, 20 % RH

Shown as left (L1)

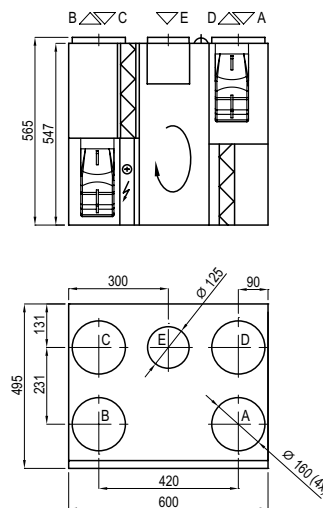

Shown as right (R1)

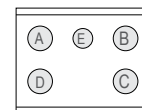

- A outdoor intake
- B supply air
- C extract indoor
- D exhaust air
- E additional extraction connection (by-pass – extraction without heat recovery)

## Performance

Unit with standard equipment

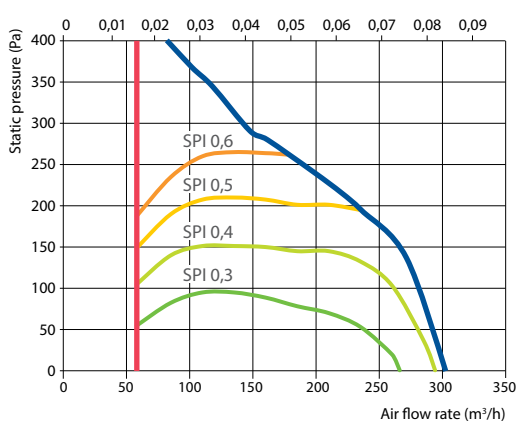

## Accessories (p. 120)

Closing damper	AGUJ-M-160+LF230/LM230
	A/D AGS-160-50-600-M
Silencer	B/C AGS-160-50-900-M
Water heater	DH-160
PPU	PPU-HW-3R-15-0,4-W1

2-way valve (water heater)	VVP47.10-0,4
Water cooler	DCW-0,4-3 / DHCW-160
2-way valve (water cooler)	VVP47.10-1,6
DX cooler	DCF-0,4-3

# Domekt R 400 H

Maximal air flow, m <sup>3</sup> /h	422
Panel thickness, mm	50
Unit weight, kg	45
Supply voltage, V	1~230
Maximal operating current, A	HE 6,3
Thermal efficiency of heat recovery, %	84
Reference flow rate, m <sup>3</sup> /s	0,082
Reference pressure difference, Pa	50
SPI, W/(m <sup>3</sup> /h)	0,35
Filters dimensions BxHxL, mm	410x200x46
Electric power input of the fan drive at reference flow rate, W	55
Electric power input of the fan drive at maximum flow rate, W	126
Electric air heater capacity, kW / Δt, °C	1/9,4
Control panel	C6.1 / C6.2
Maintenance space, mm	650

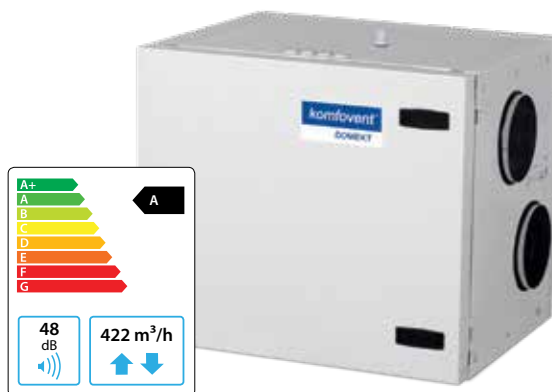

The photo is intended for informational purposes only. exact details may vary.



### Acoustic data

A-weighted sound power level L<sub>WA</sub>, dB(A)  
at reference flow rate

Supply inlet	60
Supply outlet	69
Exhaust inlet	60
Exhaust outlet	69
Casing	48

A-weighted sound pressure level L<sub>PA</sub>, dB(A)

10 m<sup>2</sup> normally isolated room, distance from casing – 3 m.

Surroundings	37
--------------	----

### Performance

Unit with standard equipment

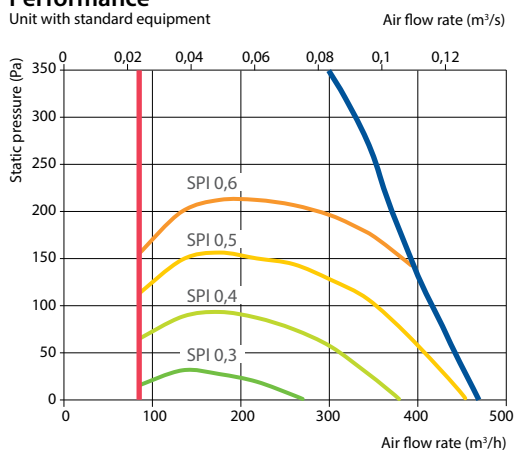

### Temperature efficiency

Outside temperature, °C	Winter					Summer		
	-23	-15	-10	-5	0	25	30	35
After heat exchanger, °C	13,4	14,9	15,9	16,8	17,8	22,6	23,5	24,5

indoor +22°C, 20 % RH

Shown as right (R1)

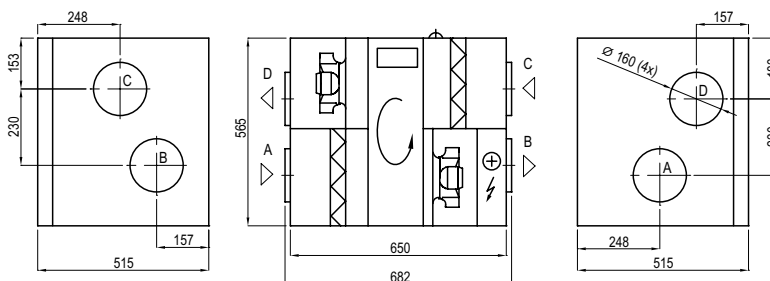

Shown as left (L1)

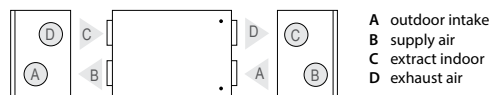

- A outdoor intake
- B supply air
- C extract indoor
- D exhaust air

### Accessories (p. 120)

Closing damper	AGUJ-M-160+LF230/LM230
	A/D AGS-160-50-600-M
Silencer	B/C AGS-160-50-900-M
Water heater	DH-160
PPU	PPU-HW-3R-15-0,4-W1

2-way valve (water heater)	VVP47.10-0,4
Water cooler	DCW-0,4-3 / DHCW-160
2-way valve (water cooler)	VVP47.10-1,6
DX cooler	DCF-0,4-3

# Domekt R 400 F

Maximal air flow, m <sup>3</sup> /h	472
Panel thickness, mm	50
Unit weight, kg	67
Supply voltage, V	1~230
Maximal operating current, A	HE7,3
Thermal efficiency of heat recovery, %	81
Reference flow rate, m <sup>3</sup> /s	0,092
Reference pressure difference, Pa	50
SPI, W/(m <sup>3</sup> /h)	0,41
Filters dimensions B×H×L, mm	278×258×46
Electric power input of the fan drive at reference flow rate, W	72
Electric power input of the fan drive at maximum flow rate, W	165
Electric air heater capacity, kW / Δt, °C	1 / 8,4
Control panel	C6.1 / C6.2
Maintenance space, mm	300

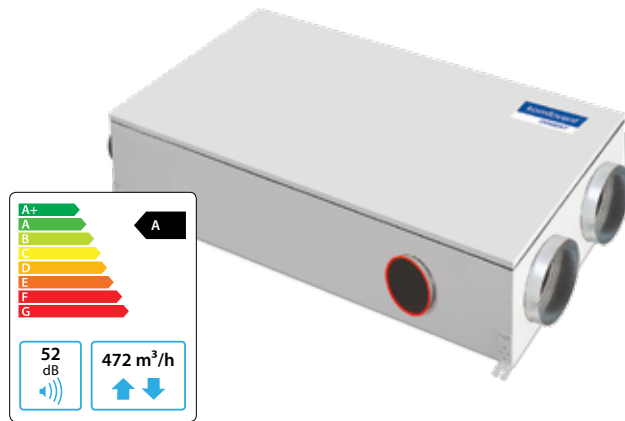

The photo is intended for informational purposes only. exact details may vary.



## Acoustic data

A-weighted sound power level  $L_{WA}$ , dB(A) at reference flow rate

Supply inlet	63
Supply outlet	72
Exhaust inlet	63
Exhaust outlet	72
Casing	52

A-weighted sound pressure level  $L_{PA}$ , dB(A)

10 m<sup>2</sup> normally isolated room, distance from casing – 3 m.

Surroundings	41
--------------	----

## Temperature efficiency

Outside temperature, °C	Winter					Summer		
	-23	-15	-10	-5	0	25	30	35
After heat exchanger, °C	11,4	13,3	14,5	15,7	16,8	22,7	23,9	25,1

indoor +22°C, 20 % RH

Shown as right (R1)

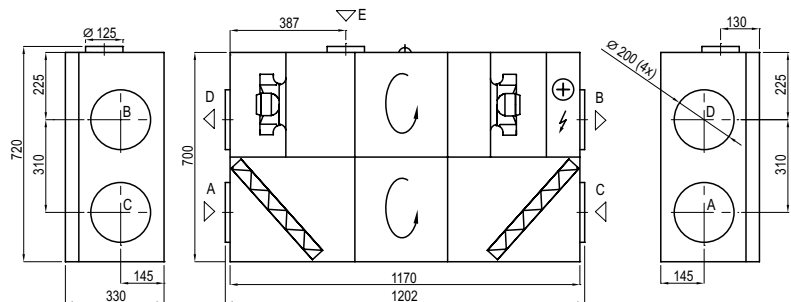

Shown as left (L1)



- A outdoor intake
- B supply air
- C extract indoor
- D exhaust air
- E additional extraction connection (by-pass – extraction without heat recovery)

## Performance

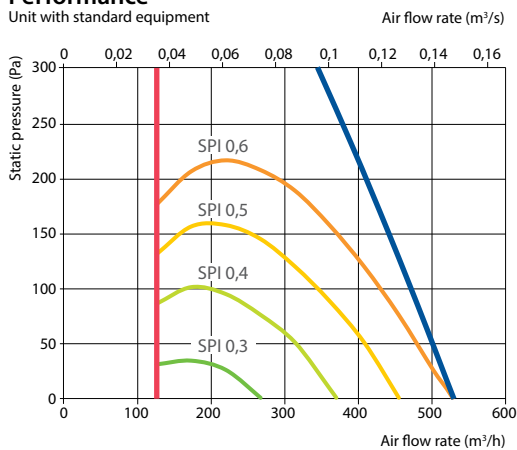

## Accessories (p. 120)

Closing damper	AGUJ-M-200+LF230/LM230
Silencer	A/D AGS-200-50-600-M
	B/C AGS-200-50-900-M
Water heater	DH-200
PPU	PPU-HW-3R-15-0,63-W1

2-way valve (water heater)	VVP47.10-0,63
Water cooler	DCW-0,4-3 / DHCW-200
2-way valve (water cooler)	VVP47.15-2,5
DX cooler	DCF-0,4-3

# Domekt R 450 V

Maximal air flow, m <sup>3</sup> /h	472
Panel thickness, mm	50
Unit weight, kg	60
Supply voltage, V	1~230
Maximal operating current, A	HE7,2
Thermal efficiency of heat recovery, %	85
Reference flow rate, m <sup>3</sup> /s	0,092
Reference pressure difference, Pa	50
SPI, W/(m <sup>3</sup> /h)	0,44
Filters dimensions BxHxL, mm	470x240x46
Electric power input of the fan drive at reference flow rate, W	72
Electric power input of the fan drive at maximum flow rate, W	170
Electric air heater capacity, kW / Δt, °C	1 / 8,4
Control panel	C6.1 / C6.2
Maintenance space, mm	500

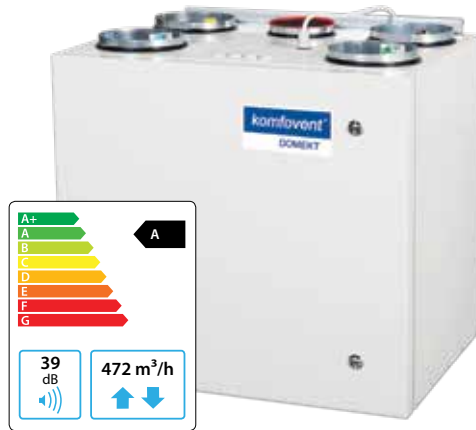

The photo is intended for informational purposes only. exact details may vary.



C6.1



C6.2

## Acoustic data

A-weighted sound power level  $L_{WA}$ , dB(A) at reference flow rate

Supply inlet	58
Supply outlet	72
Exhaust inlet	58
Exhaust outlet	72
Casing	39

A-weighted sound pressure level  $L_{PA}$ , dB(A)

10 m<sup>2</sup> normally isolated room, distance from casing – 3 m.

Surroundings	29
--------------	----

## Performance

Unit with standard equipment

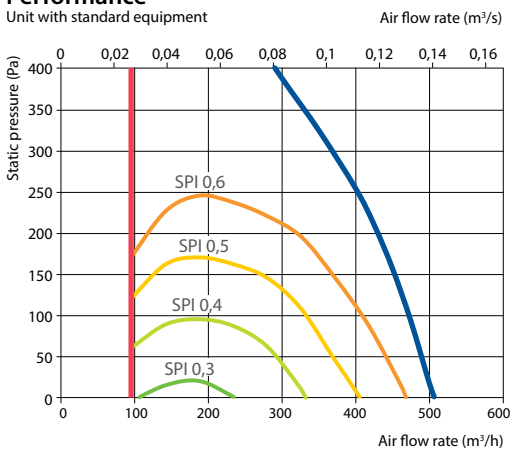

## Temperature efficiency

Outside temperature, °C	Winter					Summer		
	-23	-15	-10	-5	0	25	30	35
After heat exchanger, °C	14,0	15,4	16,3	17,2	18,1	22,5	23,4	24,3

indoor +22°C, 20 % RH

Shown as left (L1)

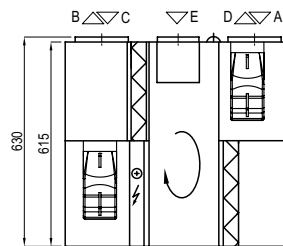

Shown as right (R1)

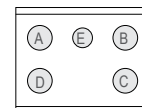

- A outdoor intake
- B supply air
- C extract indoor
- D exhaust air
- E additional extraction connection (by-pass – extraction without heat recovery)

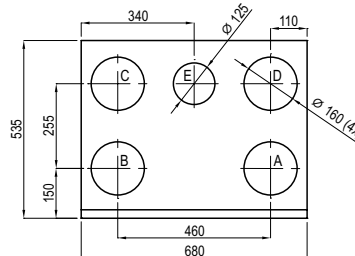

## Accessories (p. 120)

Closing damper	AGUJ-M-160+LF230/LM230
	A/D AGS-160-50-600-M
Silencer	B/C AGS-160-50-900-M
Water heater	DH-160
PPU	PPU-HW-3R-15-0,4-W1

2-way valve (water heater)	VVP47.10-0,4
Water cooler	DCW-0,5-3 / DHCW-160
2-way valve (water cooler)	VVP47.10-1,6
DX cooler	DCF-0,5-3

# Domekt R 500 V

Maximal air flow, m <sup>3</sup> /h	630
Panel thickness, mm	50
Unit weight, kg	113
Supply voltage, V	1~230
Maximal operating current, A	HE7,3
Thermal efficiency of heat recovery, %	85
Reference flow rate, m <sup>3</sup> /s	0,123
Reference pressure difference, Pa	50
SPI, W/(m <sup>3</sup> /h)	0,33
Filters dimensions BxHxL, mm	540x260x46
Electric power input of the fan drive at reference flow rate, W	77
Electric power input of the fan drive at maximum flow rate, W	144
Electric air heater capacity, kW / Δt, °C	1 / 6,3
Control panel	C6.1 / C6.2
Maintenance space, mm	1050

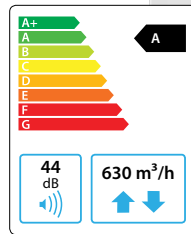

The photo is intended for informational purposes only. exact details may vary.



## Acoustic data

A-weighted sound power level  $L_{WA}$ , dB(A) at reference flow rate

Supply inlet	57
Supply outlet	65
Exhaust inlet	57
Exhaust outlet	66
Casing	44

A-weighted sound pressure level  $L_{PA}$ , dB(A)

10 m<sup>2</sup> normally isolated room, distance from casing – 3 m.

Surroundings	34
--------------	----

## Temperature efficiency

	Winter					Summer		
Outside temperature, °C	-23	-15	-10	-5	0	25	30	35
After heat exchanger, °C	14,0	15,4	16,3	17,2	18,1	22,5	23,4	24,3

indoor +22°C, 20 % RH

Shown as left (L1)

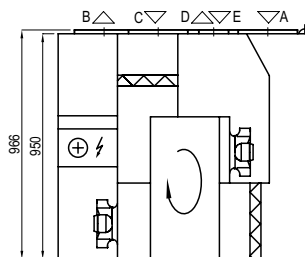

Shown as right (R1)

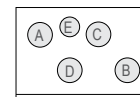

- A outdoor intake
- B supply air
- C extract indoor
- D exhaust air
- E additional extraction connection (by-pass – extraction without heat recovery)

## Performance

Unit with standard equipment

Air flow rate (m<sup>3</sup>/s)

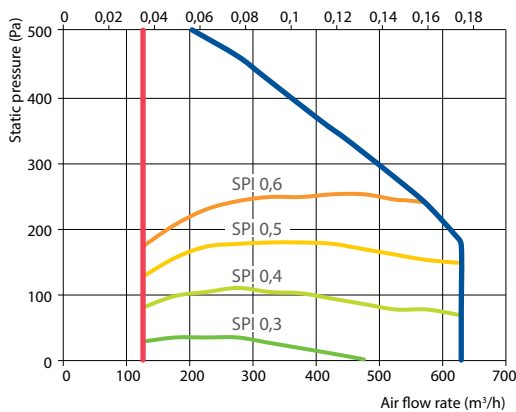

## Accessories (p. 120)

Closing damper	AGUJ-M-250+LF230/LM230
	A/D AGS-250-50-600-M
Silencer	B/C AGS-250-50-900-M
Water heater	DH-250
PPU	PPU-HW-3R-15-0,63-W1

2-way valve (water heater)	VVP47.10-0,63
Water cooler	DCW-0,5-3 / DHCW-250
2-way valve (water cooler)	VVP47.15-2,5
DX cooler	DCF-0,5-3

# Domekt R 500 H

Maximal air flow, m <sup>3</sup> /h	617
Panel thickness, mm	50
Unit weight, kg	86
Supply voltage, V	1~230
Maximal operating current, A	HE7,3
Thermal efficiency of heat recovery, %	85
Reference flow rate, m <sup>3</sup> /s	0,120
Reference pressure difference, Pa	50
SPI, W/(m <sup>3</sup> /h)	0,32
Filters dimensions BxHxL, mm	540x260x46
Electric power input of the fan drive at reference flow rate, W	73
Electric power input of the fan drive at maximum flow rate, W	180
Electric air heater capacity, kW / Δt, °C	1/6,4
Control panel	C6.1 / C6.2
Maintenance space, mm	950

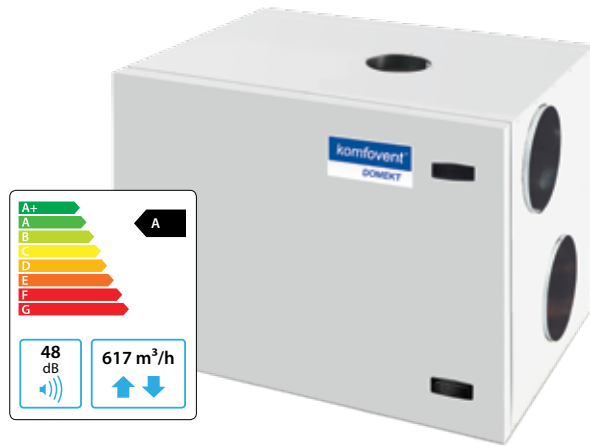

The photo is intended for informational purposes only. exact details may vary.



### Acoustic data

A-weighted sound power level L<sub>WA</sub>, dB(A) at reference flow rate

Supply inlet	59
Supply outlet	68
Exhaust inlet	59
Exhaust outlet	68
Casing	48

A-weighted sound pressure level L<sub>PA</sub>, dB(A)

10 m<sup>2</sup> normally isolated room, distance from casing – 3 m.

Surroundings	37
--------------	----

### Performance

Unit with standard equipment

Air flow rate (m<sup>3</sup>/s)

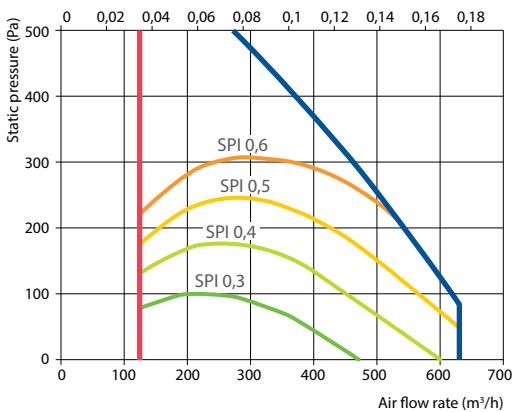

### Temperature efficiency

Outside temperature, °C	Winter					Summer		
	-23	-15	-10	-5	0	25	30	35
After heat exchanger, °C	14,0	15,5	16,3	17,2	18,1	22,5	23,4	24,3

indoor +22°C, 20 % RH

Shown as right (R1)

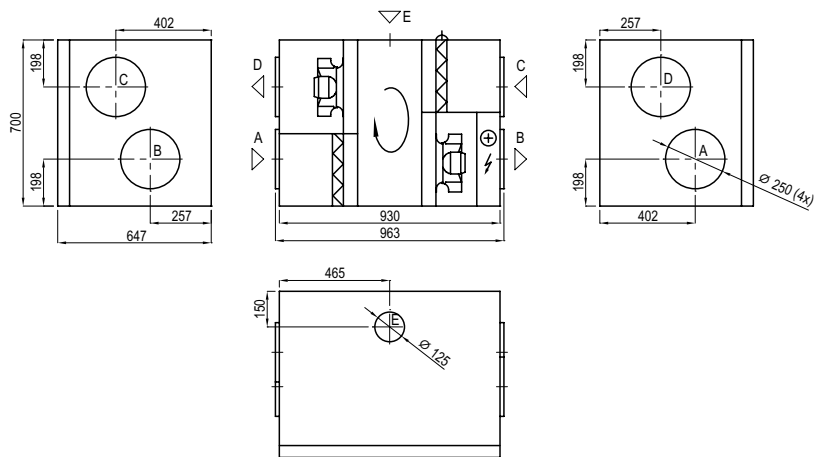

Shown as left (L1)

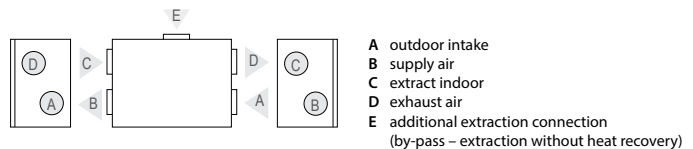

### Accessories (p. 120)

Closing damper	AGUJ-M-250+LF230/LM230
	A/D AGS-250-50-600-M
Silencer	B/C AGS-250-50-900-M
Water heater	DH-250
PPU	PPU-HW-3R-15-0,63-W1

2-way valve (water heater)	VVP47.10-0,63
Water cooler	DCW-0,5-3 / DHCW-250
2-way valve (water cooler)	VVP47.15-2,5
DX cooler	DCF-0,5-3

# Domekt R 600 H

Maximal air flow, m <sup>3</sup> /h	584
Panel thickness, mm	50
Unit weight, kg	80
Supply voltage, V	1~230
Maximal operating current, A	HE 7,3
Thermal efficiency of heat recovery, %	83
Reference flow rate, m <sup>3</sup> /s	0,114
Reference pressure difference, Pa	50
SPI, W/(m <sup>3</sup> /h)	0,35
Filters dimensions B×H×L, mm	475×235×46
Electric power input of the fan drive at reference flow rate, W	77
Electric power input of the fan drive at maximum flow rate, W	179
Electric air heater capacity, kW / Δt, °C	1 / 6,8
Control panel	C6.1 / C6.2
Maintenance space, mm	500



The photo is intended for informational purposes only. exact details may vary.



## Acoustic data

A-weighted sound power level  $L_{WA}$ , dB(A) at reference flow rate

Supply inlet	58
Supply outlet	67
Exhaust inlet	58
Exhaust outlet	67
Casing	47

A-weighted sound pressure level  $L_{pA}$ , dB(A)

10 m<sup>2</sup> normally isolated room, distance from casing – 3 m.

Surroundings	36
--------------	----

## Temperature efficiency

Outside temperature, °C	Winter					Summer		
	-23	-15	-10	-5	0	25	30	35
After heat exchanger, °C	13,1	14,7	15,7	16,7	17,6	22,6	23,6	24,6

indoor +22°C, 20 % RH

Shown as right (R1)

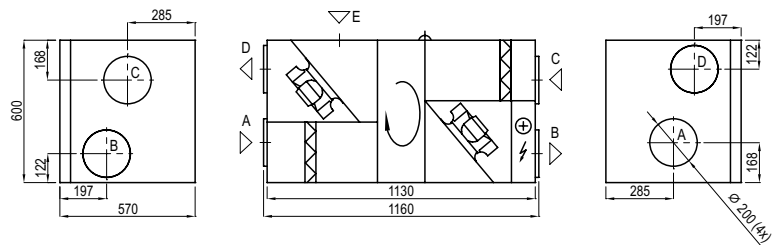

## Performance

Unit with standard equipment

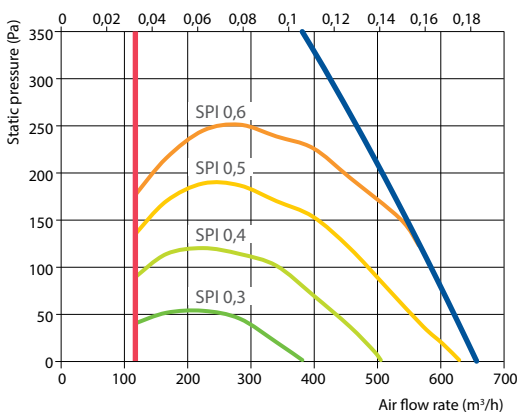

Shown as left (L1)

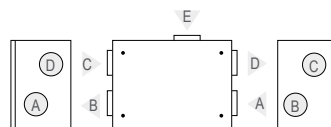

- A outdoor intake
- B supply air
- C extract indoor
- D exhaust air
- E additional extraction connection (by-pass – extraction without heat recovery)

## Accessories (p. 120)

Closing damper	AGUJ-M-200+LF230/LM230
Silencer	A/D AGS-200-50-600-M B/C AGS-200-50-900-M
Water heater	DH-200
PPU	PPU-HW-3R-15-0,63-W1

2-way valve (water heater)	VVP47.10-0,63
Water cooler	DCW-0,7-5 / DHCW-200
2-way valve (water cooler)	VVP47.15-2,5
DX cooler	DCF-0,7-5
Cooling unit	MOU-18HFN6-KA8243



# Domekt R 700 V

Maximal air flow, m <sup>3</sup> /h	764
Panel thickness, mm	50
Unit weight, kg	114
Supply voltage, V	1~230
Maximal operating current, A	HE11,7
Thermal efficiency of heat recovery, %	83
Reference flow rate, m <sup>3</sup> /s	0,149
Reference pressure difference, Pa	50
SPI, W/(m <sup>3</sup> /h)	0,26
Filters dimensions BxHxL, mm	540x260x46
Electric power input of the fan drive at reference flow rate, W	73
Electric power input of the fan drive at maximum flow rate, W	179
Electric air heater capacity, kW / Δt, °C	2 / 10,4
Control panel	C6.1 / C6.2
Maintenance space, mm	1050



The photo is intended for informational purposes only. exact details may vary.



### Acoustic data

A-weighted sound power level L<sub>WA</sub>, dB(A) at reference flow rate

Supply inlet	55
Supply outlet	63
Exhaust inlet	55
Exhaust outlet	63
Casing	44

A-weighted sound pressure level L<sub>PA</sub>, dB(A)

10 m<sup>2</sup> normally isolated room, distance from casing – 3 m.

Surroundings	34
--------------	----

### Performance

Unit with standard equipment

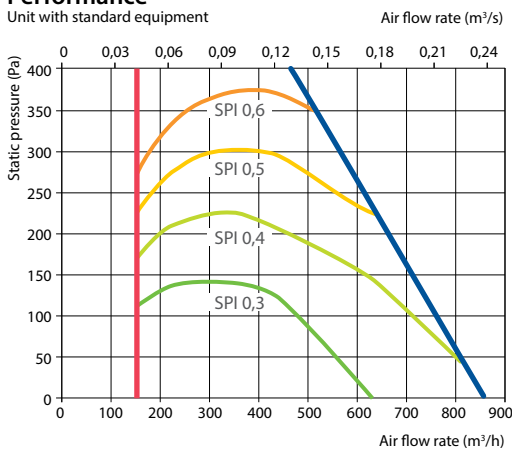

### Temperature efficiency

	Winter					Summer		
Outside temperature, °C	-23	-15	-10	-5	0	25	30	35
After heat exchanger, °C	13,1	14,7	15,7	16,7	17,7	22,6	23,6	24,6

indoor +22°C, 20 % RH

Shown as left (L1)

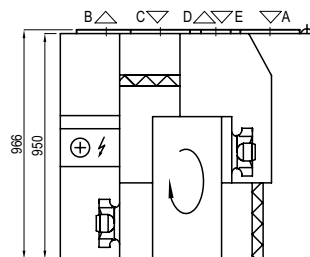

Shown as right (R1)

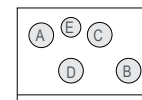

- A outdoor intake
- B supply air
- C extract indoor
- D exhaust air
- E additional extraction connection (by-pass – extraction without heat recovery)

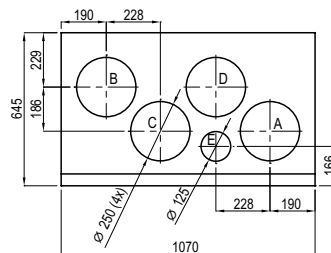

### Accessories (p. 120)

Closing damper	AGUJ-M-250+LF230/LM230
	A/D AGS-250-50-600-M
Silencer	B/C AGS-250-50-900-M
Water heater	DH-250
PPU	PPU-HW-3R-15-0,63-W1

2-way valve (water heater)	VVP47.10-0,63
Water cooler	DCW-0,7-5 / DHCW-250
2-way valve (water cooler)	VVP47.15-2,5
DX cooler	DCF-0,7-5
Cooling unit	MOU-18HFN6-KA8243

# Domekt R 700 H

Maximal air flow, m <sup>3</sup> /h	696
Panel thickness, mm	50
Unit weight, kg	87
Supply voltage, V	1~230
Maximal operating current, A	HE 11,7
Thermal efficiency of heat recovery, %	84
Reference flow rate, m <sup>3</sup> /s	0,135
Reference pressure difference, Pa	50
SPI, W/(m <sup>3</sup> /h)	0,34
Filters dimensions BxHxL, mm	540x260x46
Electric power input of the fan drive at reference flow rate, W	89
Electric power input of the fan drive at maximum flow rate, W	176
Electric air heater capacity, kW / Δt, °C	2 / 11,4
Control panel	C6.1 / C6.2
Maintenance space, mm	950

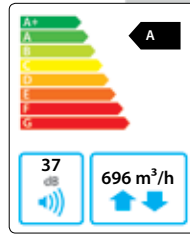

The photo is intended for informational purposes only. exact details may vary.



## Acoustic data

### A-weighted sound power level L<sub>WA</sub>, dB(A) at reference flow rate

Supply inlet	60
Supply outlet	69
Exhaust inlet	60
Exhaust outlet	69
Casing	48

### A-weighted sound pressure level L<sub>pA</sub>, dB(A)

10 m<sup>2</sup> normally isolated room, distance from casing – 3 m.

Surroundings	37
--------------	----

## Performance

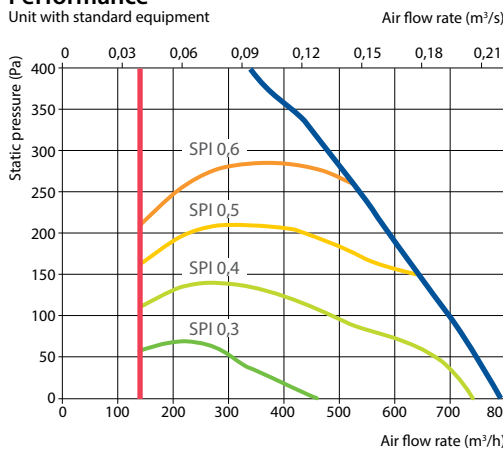

## Temperature efficiency

Outside temperature, °C	Winter					Summer		
	-23	-15	-10	-5	0	25	30	35
After heat exchanger, °C	13,6	15,1	16,0	16,9	17,9	22,6	23,5	24,4

indoor +22°C, 20 % RH

### Shown as right (R1)

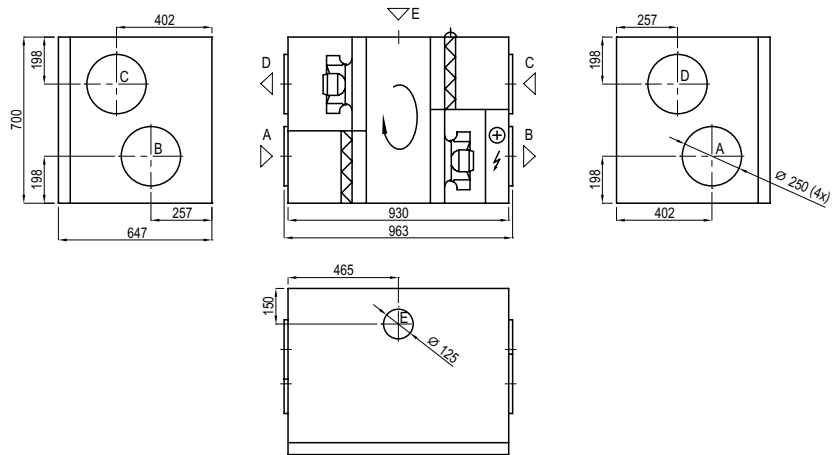

### Shown as left (L1)

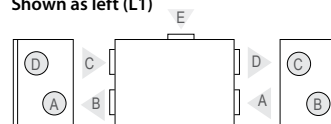

- A outdoor intake
- B supply air
- C extract indoor
- D exhaust air
- E additional extraction connection (by-pass – extraction without heat recovery)

## Accessories (p. 120)

Closing damper	AGUJ-M-250+LF230/LM230
	A/D AGS-250-50-600-M
Silencer	B/C AGS-250-50-900-M
	DH-250
Water heater	PPU-HW-3R-15-0,63-W1

2-way valve (water heater)	VVP47.10-0,63
Water cooler	DCW-0,7-5 / DHCW-250
2-way valve (water cooler)	VVP47.15-2,5
DX cooler	DCF-0,7-5
Cooling unit	MOU-18HFN6-KA8243

# Domekt R 700 F

Maximal air flow, m <sup>3</sup> /h	686
Panel thickness, mm	50
Unit weight, kg	93
Supply voltage, V	1~230
Maximal operating current, A	HE11,7
Thermal efficiency of heat recovery, %	83
Reference flow rate, m <sup>3</sup> /s	0,133
Reference pressure difference, Pa	50
SPI, W/(m <sup>3</sup> /h)	0,30
Filters dimensions BxHxL, mm	370x360x46
Electric power input of the fan drive at reference flow rate, W	76
Electric power input of the fan drive at maximum flow rate, W	176
Electric air heater capacity, kW / Δt, °C	2 / 11,6
Control panel	C6.1 / C6.2
Maintenance space, mm	430

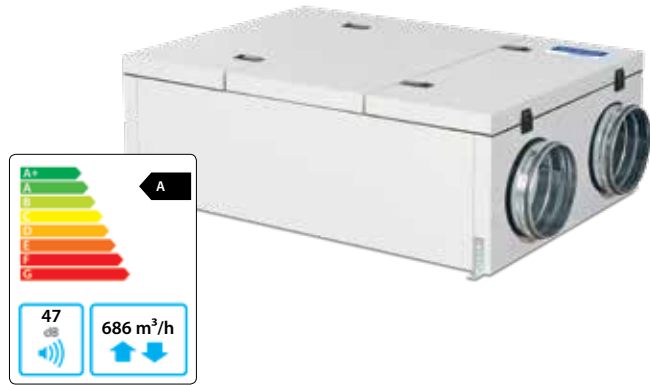

The photo is intended for informational purposes only. exact details may vary.

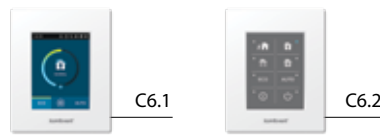

### Acoustic data

A-weighted sound power level L<sub>WA</sub>, dB(A) at reference flow rate

Supply inlet	54
Supply outlet	67
Exhaust inlet	54
Exhaust outlet	67
Casing	47

A-weighted sound pressure level L<sub>PA</sub>, dB(A)

10 m<sup>2</sup> normally isolated room, distance from casing – 3 m.

Surroundings	36
--------------	----

### Performance

Unit with standard equipment

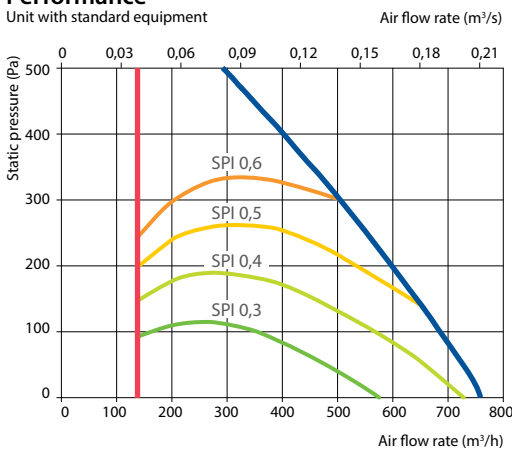

### Temperature efficiency

Outside temperature, °C	Winter					Summer		
	-23	-15	-10	-5	0	25	30	35
After heat exchanger, °C	12,6	14,3	15,3	16,4	17,4	22,6	23,7	24,7

indoor +22°C, 20 % RH

Shown as left (L1)

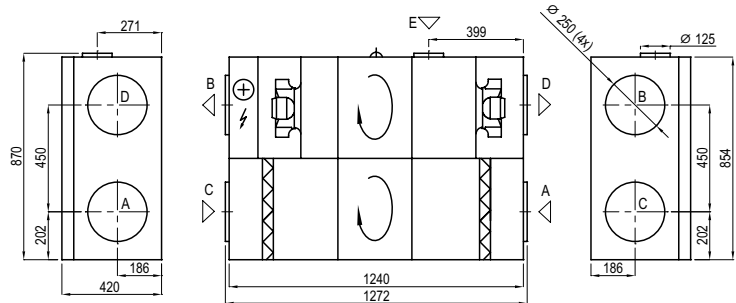

Shown as right (R1)

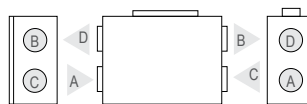

- A outdoor intake
- B supply air
- C extract indoor
- D exhaust air
- E additional extraction connection (by-pass – extraction without heat recovery)

### Accessories (p. 120)

Closing damper	AGUJ-M-250+LF230/LM230
Silencer	A/D AGS-250-50-600-M
	B/C AGS-250-50-900-M
Water heater	DH-250
PPU	PPU-HW-3R-15-0,63-W1

2-way valve (water heater)	VVP47.10-0,63
Water cooler	DCW-0,7-5 / DHCW-250
2-way valve (water cooler)	VVP47.15-2,5
DX cooler	DCF-0,7-5
Cooling unit	MOU-18HFN6-KA8243

# Domekt CF

## Air handling units with counterflow plate heat exchangers

### Sizes and capacities of Domekt CF units

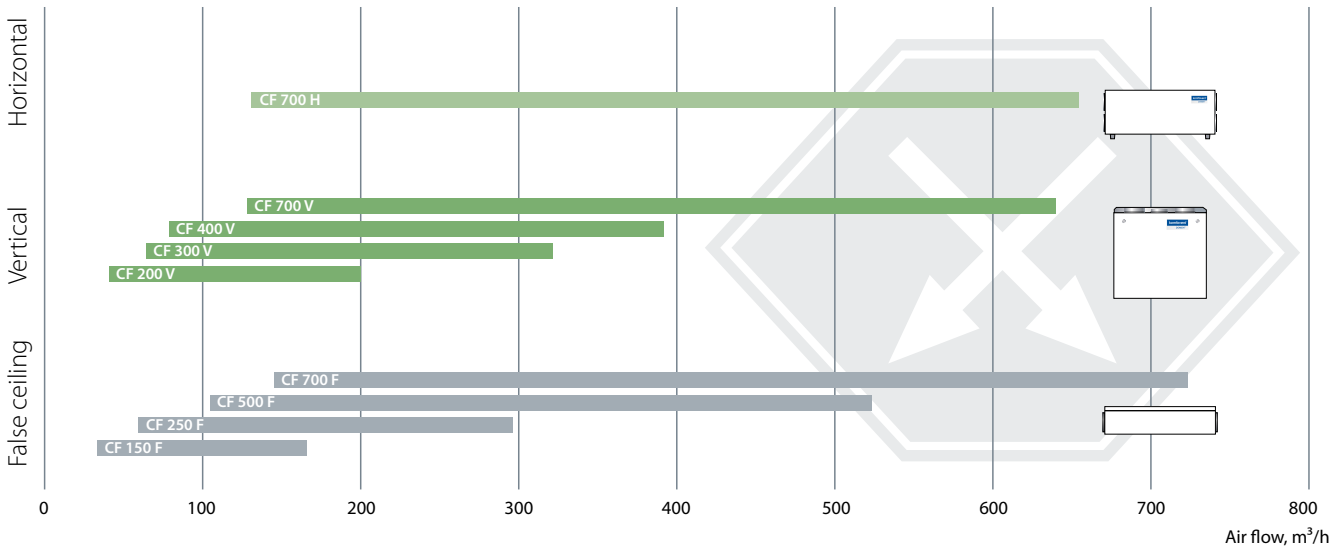

### Modifications of Domekt CF units

Unit	Heat exchanger		Supply/exhaust air filter class		Preheater	Heater			Cooler		Inspection side				Bypass	Control system/ panel C6	
	Condensing	Enthalpy	F7	M5	HE	HE	HW	HCW	CW	DX	R1	R2	L1	L2	Inner	C6.1	C6.2
Domekt CF 150 F	●	○	○	●	●	●	△	△	△	△		○	○		●	○	○
Domekt CF 200 V	●	○	○	●	●	●	△	△	△	△	○		○		●	○	○
Domekt CF 250 F	●	○	○	●	●	●	△	△	△	△	○	○	○	○	●	○	○
Domekt CF 300 V	●	○	○	●	●	●	△	△	△	△	○		○		●	○	○
Domekt CF 400 V	●	○	○	●	●	●	△	△	△	△	○		○		●	○	○
Domekt CF 500 F	●	○	○	●	●	●	△	△	△	△	○	○	○	○	●	○	○
Domekt CF 700 V	●	○	○	●	●	●	△	△	△	△	○		○		●	○	○
Domekt CF 700 H	●	○	○	●	●	●	△	△	△	△	○		○		●	○	○
Domekt CF 700 F	●	○	○	●	●	●	△	△	△	△	○	○	○	○	●	○	○

● standard equipment    ○ possible choice    △ ordered separately duct heater/cooler

The markings are explained on p. 7.

# Domekt CF 150 F/H

Maximal air flow, m <sup>3</sup> /h	165
Panel thickness, mm	30
Unit weight, kg	29
Supply voltage, V	1~230
Maximal operating current, A	6,1
Thermal efficiency of heat recovery, %	88
Reference flow rate, m <sup>3</sup> /s	0,032
Reference pressure difference, Pa	50
SPI, W/(m <sup>3</sup> /h)	0,26
Filters dimensions BxHxL, mm	260x232x46
Electric power input of the fan drive at reference flow rate, W	12
Electric power input of the fan drive at maximum flow rate, W	18
Electric air heater capacity, kW / Δt, °C	0,5 / 12
Electric preheater capacity, kW / Δt, °C	0,75 / 18
Control panel	C6.1 / 6.2
Maintenance space, mm	300



The photo is intended for informational purposes only. exact details may vary.



### Acoustic data

A-weighted sound power level L<sub>WA</sub>, dB(A) at reference flow rate

Supply inlet	48
Supply outlet	59
Exhaust inlet	48
Exhaust outlet	59
Casing	46

A-weighted sound pressure level L<sub>PA</sub>, dB(A)

10 m<sup>2</sup> normally isolated room, distance from casing – 3 m.

Surroundings	35
--------------	----

### Temperature efficiency

	Winter					Summer		
Outside temperature, °C	-23	-15	-10	-5	0	25	30	35
After heat exchanger*, °C	18,4*	18,8*	19,3*	19,3	19,5	22,3	22,9	23,5

indoor +22°C, 20 % RH.  
\* calculations made after evaluation of the preheater.

### Performance

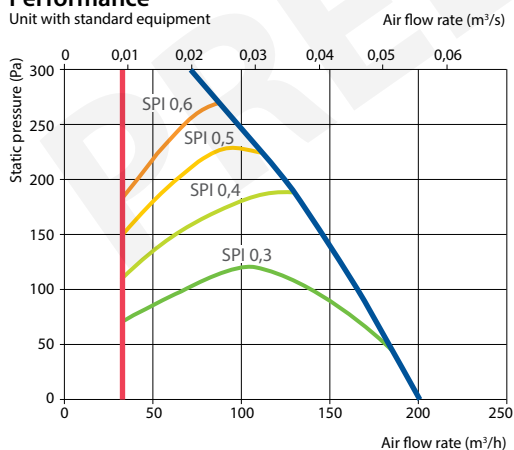

Shown as right (R2)

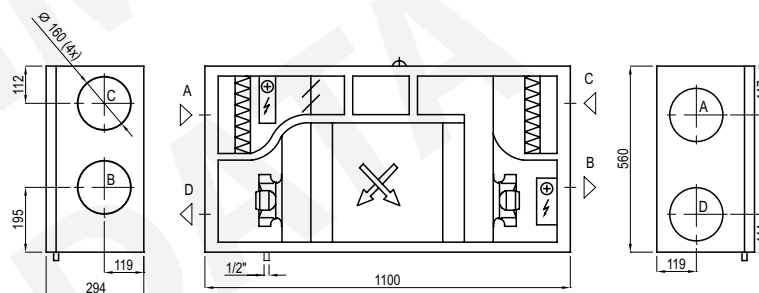

Shown as left (L1)

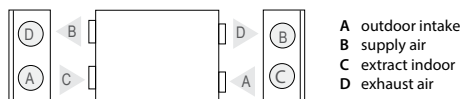

- A outdoor intake
- B supply air
- C extract indoor
- D exhaust air

### Accessories (p. 120)

Closing damper	AGUJ-M-160+LF230/LM230
	A/D AGS-160-50-600-M
Silencer	B/C AGS-160-50-900-M
Water heater	DH-160
PPU	PPU-HW-3R-15-0,4-W2

2-way valve (water heater)	VVP47.10-0,4
Water cooler	DCW-0,2-1 / DHCW-160
2-way valve (water cooler)	VVP47.10-1,6
DX cooler	DCF-0,2-1

# Domekt CF 200 V

Maximal air flow, m <sup>3</sup> /h	200
Panel thickness, mm	30
Unit weight, kg	40
Supply voltage, V	1~230
Maximal operating current, A	HE8,3
Thermal efficiency of heat recovery, %	93
Reference flow rate, m <sup>3</sup> /s	0,039
Reference pressure difference, Pa	50
SPI, W/(m <sup>3</sup> /h)	0,24
Filters dimensions BxHxL, mm	365x135x46
Electric power input of the fan drive at reference flow rate, W	16
Electric power input of the fan drive at maximum flow rate, W	34
Electric air heater capacity, kW / Δt, °C	0,5 / 9,9
Electric preheater capacity, kW / Δt, °C	1 / 19,8
Control panel	C6.1 / 6.2
Maintenance space, mm	600



The photo is intended for informational purposes only. exact details may vary.

## Acoustic data

A-weighted sound power level  $L_{WA}$ , dB(A) at reference flow rate

Supply inlet	49
Supply outlet	62
Exhaust inlet	49
Exhaust outlet	62
Casing	49

A-weighted sound pressure level  $L_{pA}$ , dB(A)

10 m<sup>2</sup> normally isolated room, distance from casing – 3 m.

Surroundings	38
--------------	----

## Temperature efficiency

Outside temperature, °C	Winter					Summer		
	-23	-15	-10	-5	0	25	30	35
After heat exchanger*, °C	19,9*	19,9*	19,9*	19,9	20,3	22,2	22,6	23

indoor +22°C, 20 % RH.

\* calculations made after evaluation of the preheater.

Shown as right (R1)

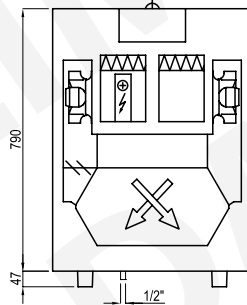

Shown as left (L1)

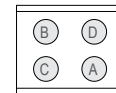
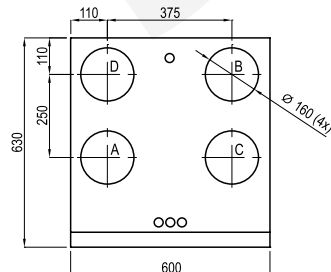

- A outdoor intake
- B supply air
- C extract indoor
- D exhaust air

## Performance

Unit with standard equipment

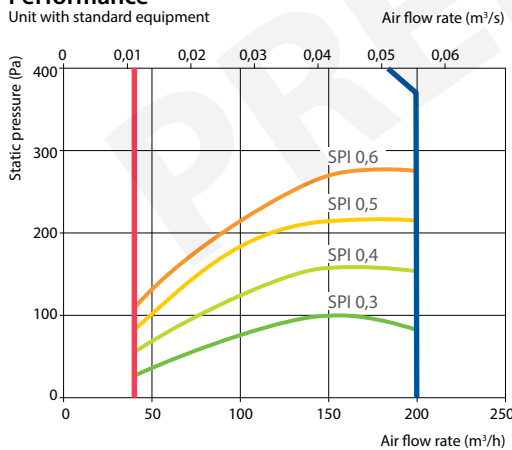

## Accessories (p. 120)

Closing damper	AGUJ-M-160+LF230/LM230
	A/D AGS-160-50-600-M
Silencer	B/C AGS-160-50-900-M
Water heater	DH-160
PPU	PPU-HW-3R-15-0,4-W2

2-way valve (water heater)	VVP47.10-0,4
Water cooler	DCW-0,2-1 / DHCW-160
2-way valve (water cooler)	VVP47.10-1,6
DX cooler	DCF-0,2-1

# Domekt CF 250 F

Maximal air flow, m <sup>3</sup> /h	295
Panel thickness, mm	30
Unit weight, kg	52
Supply voltage, V	1~230
Maximal operating current, A	8,3
Thermal efficiency of heat recovery, %	86
Reference flow rate, m <sup>3</sup> /s	0,0574
Reference pressure difference, Pa	50
SPI, W/(m <sup>3</sup> /h)	0,29
Filters dimensions BxHxL, mm	265x250x46
Electric power input of the fan drive at reference flow rate, W	32
Electric power input of the fan drive at maximum flow rate, W	89
Electric air heater capacity, kW / Δt, °C	0,5 / 6,7
Electric preheater capacity, kW / Δt, °C	1 / 13,4
Control panel	C6.1 / 6.2
Maintenance space, mm	300

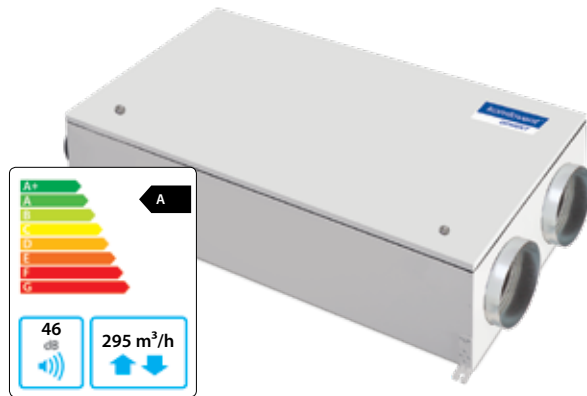

The photo is intended for informational purposes only. exact details may vary.



### Acoustic data

A-weighted sound power level L<sub>WA</sub>, dB(A) at reference flow rate

Supply inlet	53
Supply outlet	65
Exhaust inlet	54
Exhaust outlet	65
Casing	46

A-weighted sound pressure level L<sub>PA</sub>, dB(A)

10 m<sup>2</sup> normally isolated room, distance from casing – 3 m.

Surroundings	35
--------------	----

### Performance

Unit with standard equipment

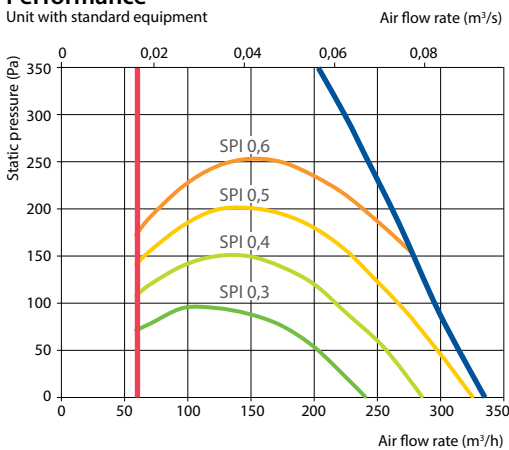

### Temperature efficiency

Outside temperature, °C	Winter					Summer		
	-23	-15	-10	-5	0	25	30	35
After heat exchanger*, °C	16,1*	17,0*	17,0*	17,0	17,9	22,6	23,5	24,4

indoor +22°C, 20 % RH.

\* calculations made after evaluation of the preheater.

Shown as right (R1)

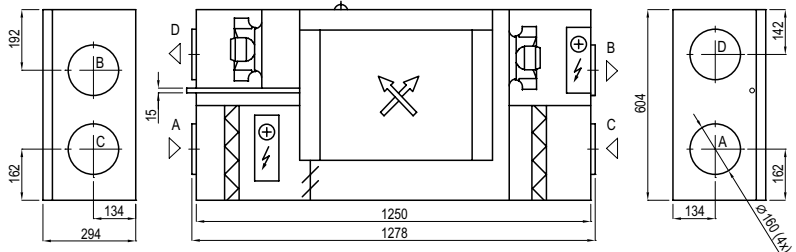

Shown as left (L1)

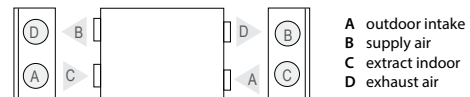

### Accessories (p. 120)

Closing damper	AGUJ-M-160+LF230/LM230
	A/D AGS-160-50-600-M
Silencer	B/C AGS-160-50-900-M
Water heater	DH-160
PPU	PPU-HW-3R-15-0,4-W1

2-way valve (water heater)	VVP47.10-0,4
Water cooler	DCW-0,2-1 / DHCW-160
2-way valve (water cooler)	VVP47.10-1,6
DX cooler	DCF-0,2-1

# Domekt CF 300 V

Maximal air flow, m <sup>3</sup> /h	320
Panel thickness, mm	30
Unit weight, kg	40
Supply voltage, V	1~230
Maximal operating current, A	HE 10,5
Thermal efficiency of heat recovery, %	89
Reference flow rate, m <sup>3</sup> /s	0,062
Reference pressure difference, Pa	50
SPI, W/(m <sup>3</sup> /h)	0,32
Filters dimensions B×H×L, mm	365×135×46
Electric power input of the fan drive at reference flow rate, W	33
Electric power input of the fan drive at maximum flow rate, W	71
Electric air heater capacity, kW / Δt, °C	0,5 / 6,2
Electric preheater capacity, kW / Δt, °C	1,5 / 18,6
Control panel	C6.1 / 6.2
Maintenance space, mm	600



The photo is intended for informational purposes only. exact details may vary.

## Acoustic data

A-weighted sound power level  $L_{WA}$ , dB(A) at reference flow rate

Supply inlet	51
Supply outlet	47
Exhaust inlet	51
Exhaust outlet	64
Casing	50

A-weighted sound pressure level  $L_{pA}$ , dB(A)

10 m<sup>2</sup> normally isolated room, distance from casing – 3 m.

Surroundings	39
--------------	----

## Temperature efficiency

Outside temperature, °C	Winter					Summer		
	-23	-15	-10	-5	0	25	30	35
After heat exchanger*, °C	18,8*	18,8*	18,8*	18,8	19,4	22,4	23	23,6

indoor +22°C, 20 % RH.

\* calculations made after evaluation of the preheater.

Shown as right (R1)

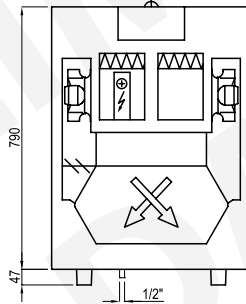

Shown as left (L1)

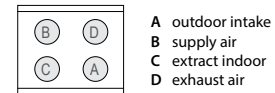
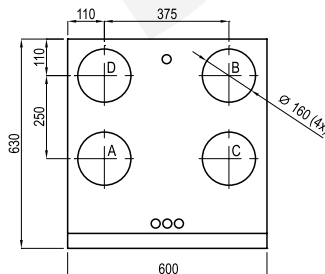

## Performance

Unit with standard equipment

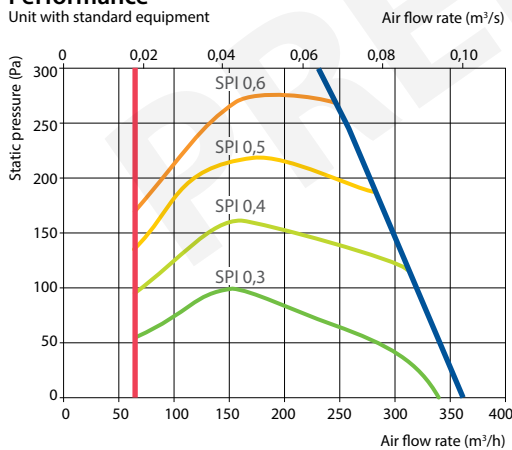

## Accessories (p. 120)

Closing damper	AGUJ-M-160+LF230/LM230
	A/D AGS-160-50-600-M
Silencer	B/C AGS-160-50-900-M
Water heater	DH-160
PPU	PPU-HW-3R-15-0,4-W2

2-way valve (water heater)	VVP47.10-0,4
Water cooler	DCW-0,4-3 / DHCW-160
2-way valve (water cooler)	VVP47.10-1,6
DX cooler	DCF-0,4-3



# Domekt CF 400 V

Maximal air flow, m <sup>3</sup> /h	390
Panel thickness, mm	30
Unit weight, kg	54
Supply voltage, V	1~230
Maximal operating current, A	HE 10.5
Thermal efficiency of heat recovery, %	88
Reference flow rate, m <sup>3</sup> /s	0,0758
Reference pressure difference, Pa	50
SPI, W/(m <sup>3</sup> /h)	0,22
Filters dimensions BxHxL, mm	350x235x46
Electric power input of the fan drive at reference flow rate, W	33
Electric power input of the fan drive at maximum flow rate, W	91
Electric air heater capacity, kW / Δt, °C	0,5 / 5,1
Electric preheater capacity, kW / Δt, °C	1,5 / 15,3
Control panel	C6.1 / 6.2
Maintenance space, mm	600



The photo is intended for informational purposes only. exact details may vary.



### Acoustic data

A-weighted sound power level  $L_{WA}$ , dB(A)  
at reference flow rate

Supply inlet	58
Supply outlet	53
Exhaust inlet	58
Exhaust outlet	53
Casing	41

A-weighted sound pressure level  $L_{PA}$ , dB(A)

10 m<sup>2</sup> normally isolated room, distance from casing – 3 m.

Surroundings	31
--------------	----

### Performance

Unit with standard equipment

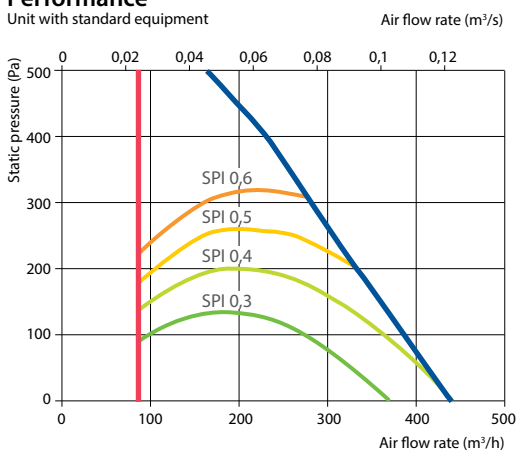

### Temperature efficiency

Outside temperature, °C	Winter					Summer		
	-23	-15	-10	-5	0	25	30	35
After heat exchanger*, °C	17,4*	17,9*	17,9*	17,9	18,6	22,5	23,2	24,0

indoor +22°C, 20% RH.

\* calculations made after evaluation of the preheater.

Shown as right (R1)

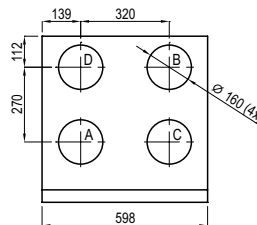
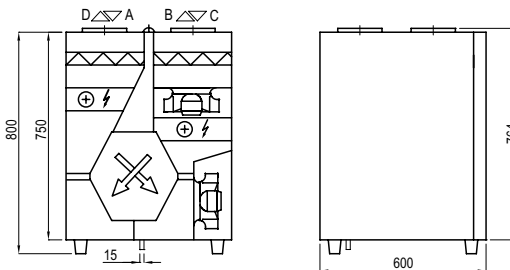

Shown as left (L1)

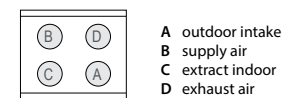

### Accessories (p. 120)

Closing damper	AGUJ-M-160+LF230/LM230
	A/D AGS-160-50-600-M
Silencer	B/C AGS-160-50-900-M
Water heater	DH-160
PPU	PPU-HW-3R-15-0,4-W1

2-way valve (water heater)	VVP47.10-0,4
Water cooler	DCW-0,4-3 / DHCW-160
2-way valve (water cooler)	VVP47.10-1,6
DX cooler	DCF-0,4-3

# Domekt CF 500 F

Maximal air flow, m <sup>3</sup> /h	521
Panel thickness, mm	30
Unit weight, kg	93
Supply voltage, V	1~230
Maximal operating current, A	HE 11,7
Thermal efficiency of heat recovery, %	87
Reference flow rate, m <sup>3</sup> /s	0,1013
Reference pressure difference, Pa	50
SPI, W/(m <sup>3</sup> /h)	0,34
Filters dimensions B×H×L, mm	484×250×46
Electric power input of the fan drive at reference flow rate, W	67
Electric power input of the fan drive at maximum flow rate, W	171
Electric air heater capacity, kW / Δt, °C	0,5 / 3,8
Electric preheater capacity, kW / Δt, °C	1,5 / 11,4
Control panel	C6.1 / 6.2
Maintenance space, mm	520

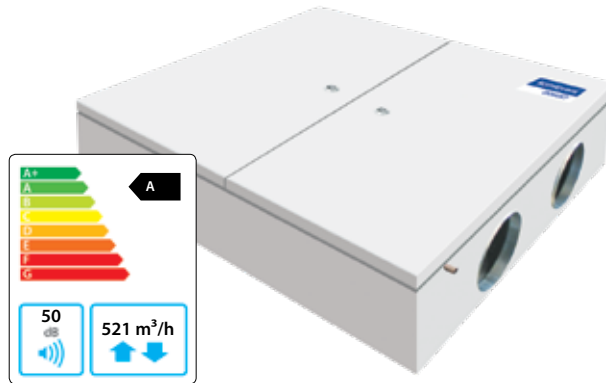

The photo is intended for informational purposes only. exact details may vary.



## Acoustic data

### A-weighted sound power level L<sub>WA</sub>, dB(A) at reference flow rate

Supply inlet	56
Supply outlet	70
Exhaust inlet	56
Exhaust outlet	70
Casing	50

### A-weighted sound pressure level L<sub>pA</sub>, dB(A)

10 m<sup>2</sup> normally isolated room, distance from casing – 3 m.

Surroundings	38
--------------	----

## Temperature efficiency

Outside temperature, °C	Winter					Summer		
	-23	-15	-10	-5	0	25	30	35
After heat exchanger*, °C	17,4*	18,0*	18,2*	18,2	18,8	22,4	23,2	24,0

indoor +22°C, 20 % RH.

\* calculations made after evaluation of the preheater.

### Shown as right (R2)

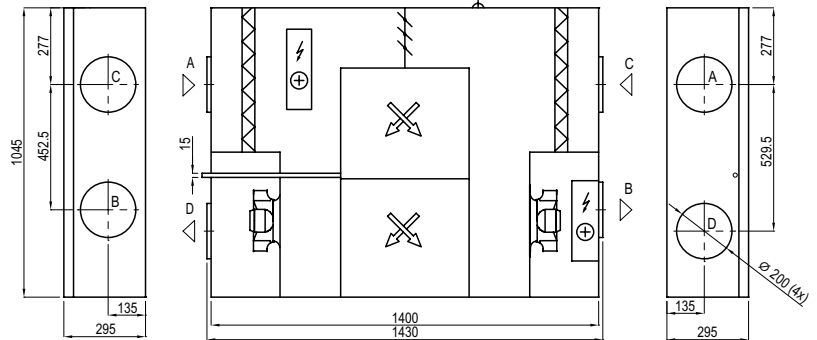

### Shown as left (L2)

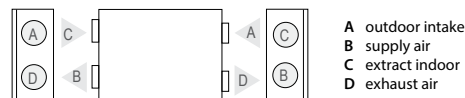

## Performance

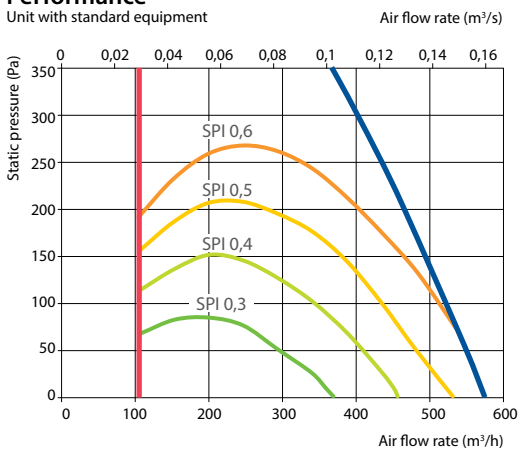

## Accessories (p. 120)

Closing damper	AGUJ-M-200+LF230/LM230
Silencer	A/D AGS-200-50-600-M
	B/C AGS-200-50-900-M
Water heater	DH-200
PPU	PPU-HW-3R-15-0,4-W1

2-way valve (water heater)	VVP47.10-0,4
Water cooler	DCW-0,5-3 / DHCW-200
2-way valve (water cooler)	VVP47.10-1,6
DX cooler	DCF-0,5-3

# Domekt CF 700 V

Maximal air flow, m <sup>3</sup> /h	637
Panel thickness, mm	50
Unit weight, kg	100
Supply voltage, V	1~230
Maximal operating current, A	HE 11,7
Thermal efficiency of heat recovery, %	88
Reference flow rate, m <sup>3</sup> /s	0,1239
Reference pressure difference, Pa	50
SPI, W/(m <sup>3</sup> /h)	0,30
Filters dimensions BxHxL, mm	390x300x46
Electric power input of the fan drive at reference flow rate, W	73
Electric power input of the fan drive at maximum flow rate, W	179
Electric air heater capacity, kW / Δt, °C	0,5 / 3,1
Electric preheater capacity, kW / Δt, °C	1,5 / 9,3
Control panel	C6.1 / 6.2
Maintenance space, mm	1000

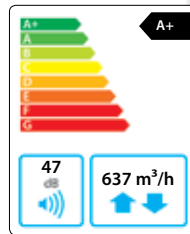

The photo is intended for informational purposes only. exact details may vary.



C6.1



C6.2

### Acoustic data

A-weighted sound power level  $L_{WA}$ , dB(A) at reference flow rate

Supply inlet	47
Supply outlet	67
Exhaust inlet	47
Exhaust outlet	67
Casing	47

A-weighted sound pressure level  $L_{PA}$ , dB(A)

10 m<sup>2</sup> normally isolated room, distance from casing – 3 m.

Surroundings	36
--------------	----

### Temperature efficiency

Outside temperature, °C	Winter					Summer		
	-23	-15	-10	-5	0	25	30	35
After heat exchanger*, °C	17,3*	17,9*	18,1*	18,1	18,8	22,4	23,2	23,9

indoor +22°C, 20 % RH.

\* calculations made after evaluation of the preheater.

Shown as left (L1)

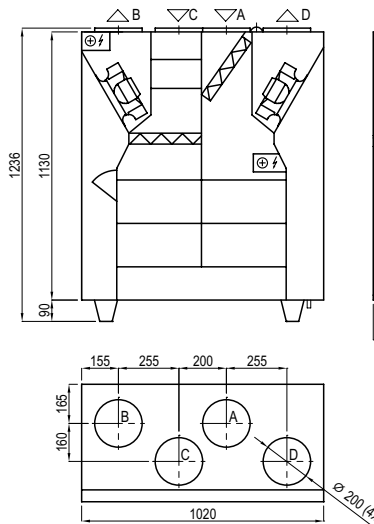

Shown as right (R1)

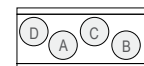

- A outdoor intake
- B supply air
- C extract indoor
- D exhaust air

### Performance

Unit with standard equipment

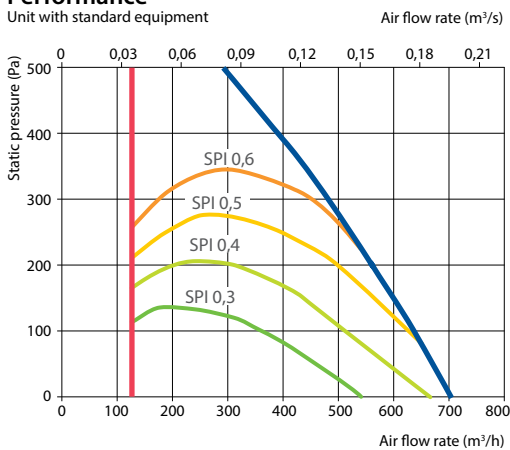

### Accessories (p. 120)

Closing damper	AGUJ-M-200+LF230/LM230
Silencer	A/D AGS-200-50-600-M
	B/C AGS-200-50-900-M
Water heater	DH-200
PPU	PPU-HW-3R-15-0,4-W1

2-way valve (water heater)	VVP47.10-0,4
Water cooler	DCW-0,7-5 / DHCW-200
2-way valve (water cooler)	VVP47.15-2,5
DX cooler	DCF-0,7-5
Cooling unit	MOU-18HFN6-KA8243

# Domekt CF 700 H

Maximal air flow, m <sup>3</sup> /h	651
Panel thickness, mm	50
Unit weight, kg	115
Supply voltage, V	1~230
Maximal operating current, A	HE 11,7
Thermal efficiency of heat recovery, %	88
Reference flow rate, m <sup>3</sup> /s	0,1266
Reference pressure difference, Pa	50
SPI, W/(m <sup>3</sup> /h)	0,29
Filters dimensions BxHxL, mm	390x300x46
Electric power input of the fan drive at reference flow rate, W	72
Electric power input of the fan drive at maximum flow rate, W	178
Electric air heater capacity, kW / Δt, °C	0,5 / 3,0
Electric preheater capacity, kW / Δt, °C	1,5 / 9,1
Control panel	C6.1 / 6.2
Maintenance space, mm	500



The photo is intended for informational purposes only. exact details may vary.



## Acoustic data

A-weighted sound power level  $L_{WA}$ , dB(A) at reference flow rate

Supply inlet	47
Supply outlet	67
Exhaust inlet	47
Exhaust outlet	67
Casing	47

A-weighted sound pressure level  $L_{pA}$ , dB(A)

10 m<sup>2</sup> normally isolated room, distance from casing – 3 m.

Surroundings	36
--------------	----

## Temperature efficiency

Outside temperature, °C	Winter					Summer		
	-23	-15	-10	-5	0	25	30	35
After heat exchanger*, °C	17,2*	17,7*	18,0*	18,0	18,8	22,4	23,2	23,9

indoor +22°C, 20% RH.  
\* calculations made after evaluation of the preheater.

## Performance

Unit with standard equipment

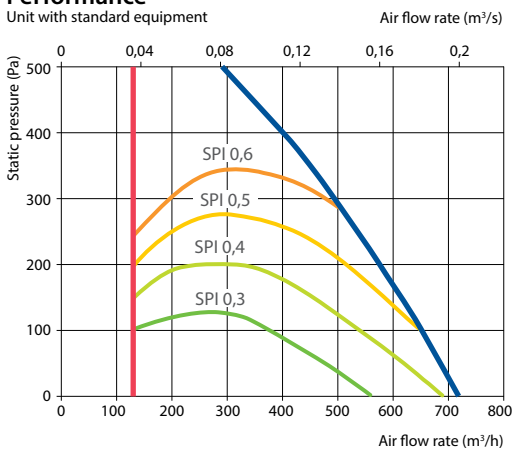

Shown as right (R1)

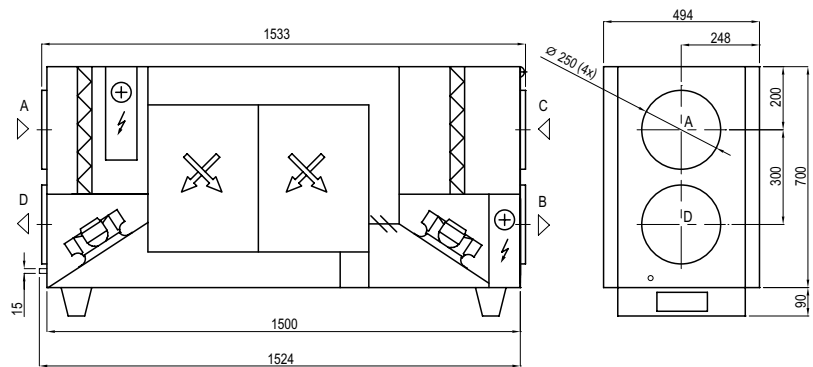

Shown as left (L1)



## Accessories (p. 120)

Closing damper	AGUJ-M-250+LF230/LM230
Silencer	A/D AGS-250-50-600-M
	B/C AGS-250-50-900-M
Water heater	DH-250
PPU	PPU-HW-3R-15-0,63-W1

2-way valve (water heater)	VVP47.10-0,63
Water cooler	DCW-0,7-5 / DHCW-250
2-way valve (water cooler)	VVP47.15-2,5
DX cooler	DCF-0,7-5
Cooling unit	MOU-18HFN6-KA8243

# Domekt CF 700 F

Maximal air flow, m <sup>3</sup> /h	720
Panel thickness, mm	30
Unit weight, kg	81
Supply voltage, V	1~230
Maximal operating current, A	HE 11,7
Thermal efficiency of heat recovery, %	82
Reference flow rate, m <sup>3</sup> /s	0,14
Reference pressure difference, Pa	50
SPI, W/(m <sup>3</sup> /h)	0,25
Filters dimensions BxHxL, mm	400x300x46
Electric power input of the fan drive at reference flow rate, W	70
Electric power input of the fan drive at maximum flow rate, W	177
Electric air heater capacity, kW / Δt, °C	0,5 / 2,8
Electric preheater capacity, kW / Δt, °C	1,5 / 8,3
Control panel	C6.1 / 6.2
Maintenance space, mm	450



The photo is intended for informational purposes only. exact details may vary.



### Acoustic data

A-weighted sound power level L<sub>WA</sub>, dB(A) at reference flow rate

Supply inlet	53
Supply outlet	66
Exhaust inlet	53
Exhaust outlet	66
Casing	46

A-weighted sound pressure level L<sub>PA</sub>, dB(A)

10 m<sup>2</sup> normally isolated room, distance from casing – 3 m.

Surroundings	35
--------------	----

### Performance

Unit with standard equipment

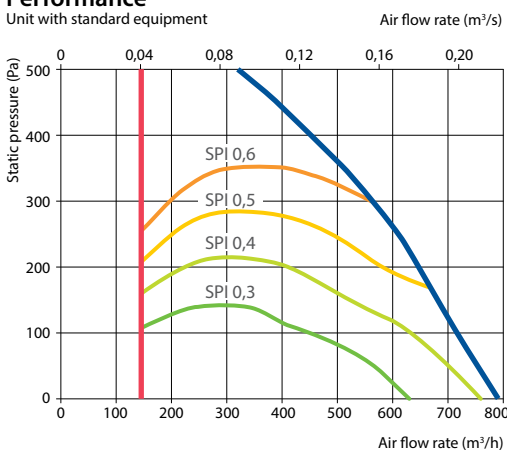

### Temperature efficiency

Outside temperature, °C	Winter					Summer		
	-23	-15	-10	-5	0	25	30	35
After heat exchanger*, °C	15,5*	16,1*	16,8*	16,8	17,7	22,5	23,5	24,4

indoor +22°C, 20 % RH.

\* calculations made after evaluation of the preheater.

### Shown as right (R1)

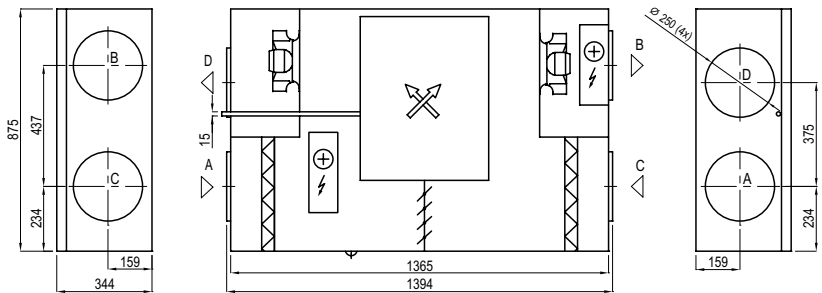

### Shown as left (L1)

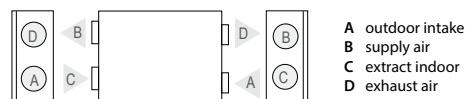

### Accessories (p. 120)

Closing damper	AGUJ-M-250+LF230/LM230
Silencer	A/D AGS-250-50-600-M B/C AGS-250-50-900-M
Water heater	DH-250
PPU	PPU-HW-3R-15-0,63-W1

2-way valve (water heater)	VVP47.10-0,63
Water cooler	DCW-0,7-5 / DHCW-250
2-way valve (water cooler)	VVP47.15-2,5
DX cooler	DCF-0,7-5
Cooling unit	MOU-18HFN6-KA8243

# Domekt S

## False ceiling supply air handling units

### Sizes and capacities of Domekt S units

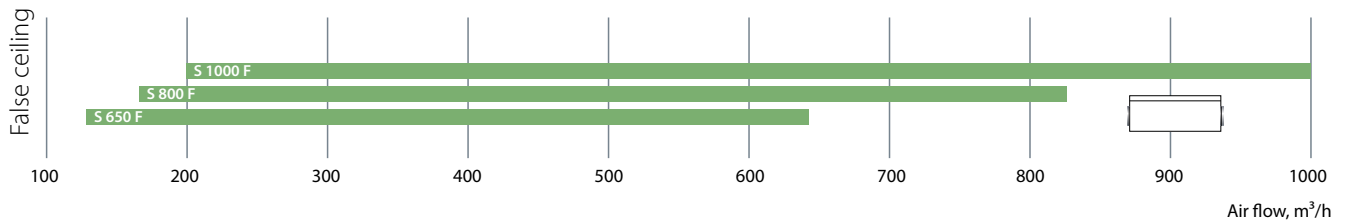

### Modifications of Domekt S units

Unit	Supply / exhaust air filter class		Heater		Cooler		Inspection side		C5 panel
	F7	M5	HE	HW	CW	DX	R1	L1	C5.1
Domekt S 650 F	○	●	●		△	△	○	○	●
Domekt S 800 F	○	●	●	○	△	△	○	○	●
Domekt S 1000 F	○	●	●	○	△	△	○	○	●

● standard equipment    ○ possible choice    △ ordered separately duct heater/cooler

The markings are explained on p. 7.



# Domekt S 650 F

Maximal air flow, m <sup>3</sup> /h	642
Panel thickness, mm	50
Unit weight, kg	35
Reference flow rate, m <sup>3</sup> /s	0,125
Reference pressure difference, Pa	50
SPI, W/(m <sup>3</sup> /h)	0,15
Filters dimensions BxHxL, mm	371x235x46
Electric power input of the fan drive at reference flow rate, W	63
Electric power input of the fan drive at maximum flow rate, W	172
Control panel	C5.1
Maintenance space, mm	300

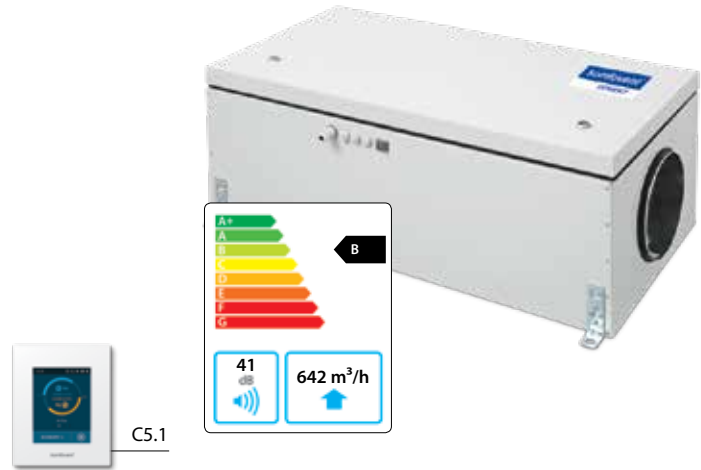

The photo is intended for informational purposes only. exact details may vary.

## Acoustic data

**A-weighted sound power level  $L_{WA}$ , dB(A)**  
at reference flow rate

Supply inlet	63
Supply outlet	69
Casing	41

**A-weighted sound pressure level  $L_{PA}$ , dB(A)**

10 m<sup>2</sup> normally isolated room, distance from casing – 3 m.

Surroundings	30
--------------	----

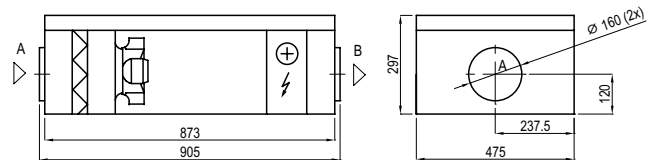

## Performance

Unit with standard equipment

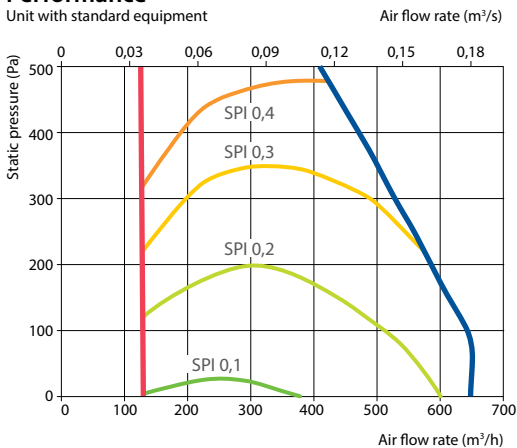

## Technical data

Supply air handling unit	Supply voltage, V	Air heater capacity, kW	Maximal operating current, A	$\Delta T$ , °C
Domekt S 650 F-HE/3	1~230	3,0	14,7	13
Domekt S 650 F-HE/6	3~400	6,0	10,4	26

## Accessories (p. 120)

Closing damper	AGUJ-M-160+LF24/LM24
Silencer	A AGS-160-50-600-M
	B AGS-160-50-900-M
PPU	-
Air heater-cooler	DCW-0,7-5
2-way valve	VVP47.15-2,5+SSP61
DX cooler	DCF-0,7-5
Cooling unit	MOU-18HFN6+KA8243

# Domekt S 800 F

Maximal air flow, m <sup>3</sup> /h	826
Panel thickness, mm	50
Unit weight, kg	37
Reference flow rate, m <sup>3</sup> /s	0,161
Reference pressure difference, Pa	50
SPI, W/(m <sup>3</sup> /h)	0,14
Filters dimensions B×H×L, mm	371×287×46
Electric power input of the fan drive at reference flow rate, W	75
Electric power input of the fan drive at maximum flow rate, W	181
Control panel	C5.1
Maintenance space, mm	400

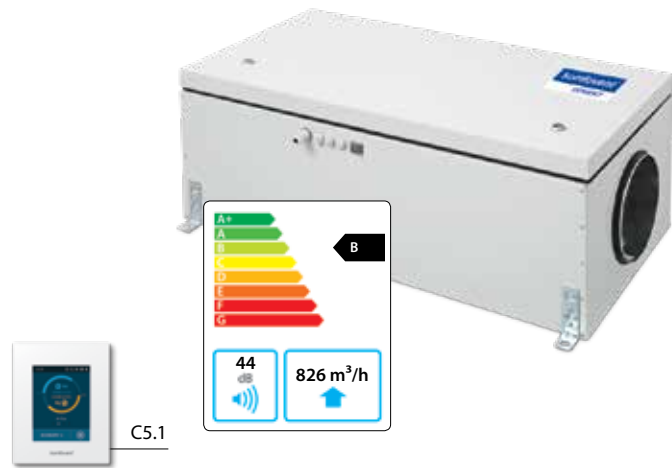

The photo is intended for informational purposes only. exact details may vary.

## Acoustic data

A-weighted sound power level  $L_{WA}$ , dB(A)  
at reference flow rate

Supply inlet	60
Supply outlet	65
Casing	44

A-weighted sound pressure level  $L_{PA}$ , dB(A)

10 m<sup>2</sup> normally isolated room, distance from casing – 3 m.

Surroundings	33
--------------	----

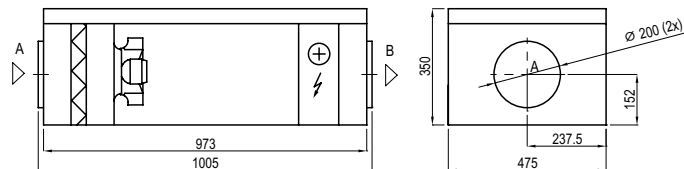

## Performance

Unit with standard equipment

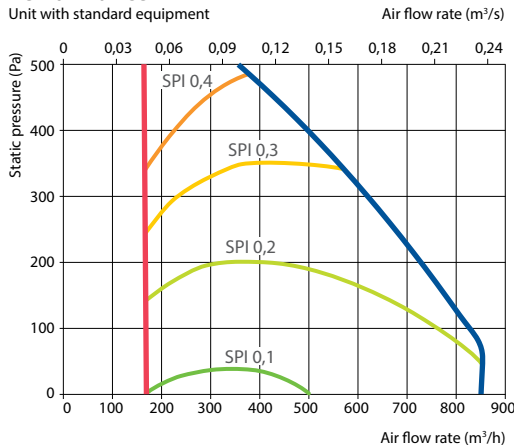

## Technical data

Supply air handling unit	Supply voltage, V	Air heater capacity, kW	Maximal operating current, A	ΔT, °C
Domekt S 800 F-HE/6	3~400	6,0	10,3	20,2
Domekt S 800 F-HE/9	3~400	9,0	14,6	30,3
Domekt S 800 F-HW	1~230	-	1,9	-

## Hot water air heater

Water temperature in/out, °C	80/60	70/50	60/40
Capacity, kW	6,3	5,2	4,1
Flow rate, dm <sup>3</sup> /h	277	230	181
Pressure drop, kPa	4,8	3,8	3
Temperature in/out, °C	-5/20,0	-5/15,9	-5/11,6
Maximal capacity, kW	6,3	5,2	4,1
Connection, "		½	

## Accessories (p. 120)

Closing damper	AGUJ-M-200+LF24/LM24
Silencer	A AGS-200-50-600-M
	B AGS-200-50-900-M
PPU	PPU-HW-3R-15-1,6-W2
Air heater-cooler	DCW-0,9-6
2-way valve	VVP47.15-2,5+SSP61
DX cooler	DCF-0,9-6
Cooling unit	MOU-18HFN6-KA8243

# Domekt S 1000 F

Maximal air flow, m <sup>3</sup> /h	1000
Panel thickness, mm	50
Unit weight, kg	46
Reference flow rate, m <sup>3</sup> /s	0,194
Reference pressure difference, Pa	50
SPI, W/(m <sup>3</sup> /h)	0,12
Filters dimensions BxHxL, mm	558x287x46
Electric power input of the fan drive at reference flow rate, W	82
Electric power input of the fan drive at maximum flow rate, W	182
Control panel	C5.1
Maintenance space, mm	400

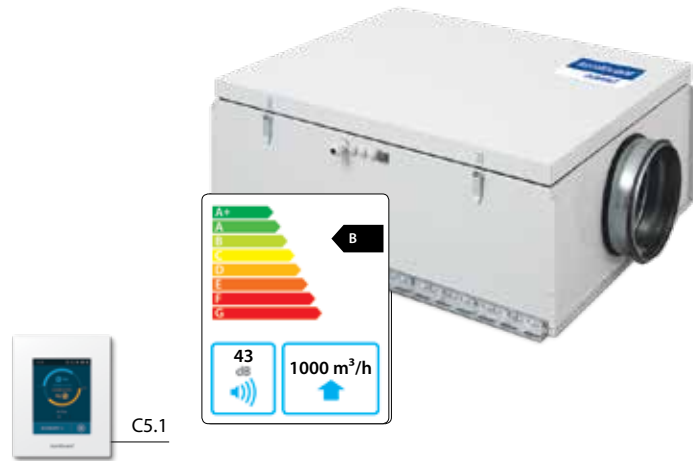

The photo is intended for informational purposes only. exact details may vary.

## Acoustic data

A-weighted sound power level  $L_{WA}$  dB(A) at reference flow rate

Supply inlet	60
Supply outlet	66
Casing	43

A-weighted sound pressure level  $L_{PA}$  dB(A)

10 m<sup>2</sup> normally isolated room, distance from casing – 3 m.

Surroundings	32
--------------	----

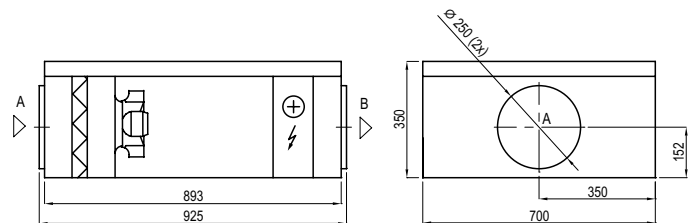

## Performance

Unit with standard equipment

Air flow rate (m<sup>3</sup>/s)

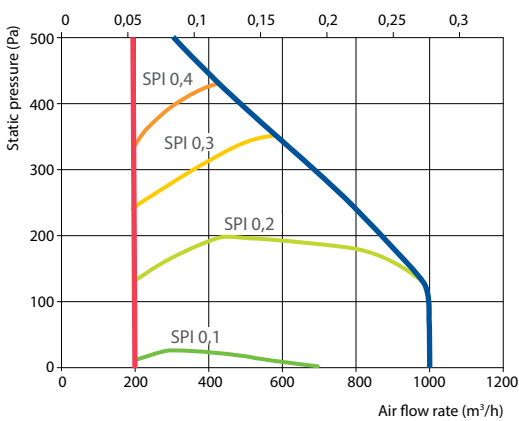

## Technical data

Supply air handling unit	Supply voltage, V	Air heater capacity, kW	Maximal operating current, A	$\Delta T$ , °C
Domekt S 1000 F-HE/9	3~400	9,0	14,6	25
Domekt S 1000 F-HE/15	3~400	15,0	23,3	41,7
Domekt S 1000 F-HW	1~230	–	1,9	–

## Hot water air heater

Water temperature in/out, °C	80/60	70/50	60/40
Capacity, kW	8,1	8,0	6,5
Flow rate, dm <sup>3</sup> /h	358	351	286
Pressure drop, kPa	8,1	7,9	6,0
Temperature in/out, °C	-5/20	-5/19,7	-5/15,2
Maximal capacity, kW	9,4	8,0	6,5
Connection, "		½	

## Accessories (p. 120)

Closing damper	AGUJ-M-250+LF24/LM24
Silencer	A AGS-250-50-600-M
	B AGS-250-50-900-M
PPU	PPU-HW-3R-15-1.6-W2
Air heater-cooler	DCW-0,9-6
2-way valve	VVP47.15-2,5+SSP61
DX cooler	DCF-0,9-6
Cooling unit	MOU-18HFN6-KA8243

# VERSO

Commercial ventilation units



800–40 000 m<sup>3</sup>/h



### Energy recovery

Non-freezing rotary heat exchangers efficiently recover heat and cold, control humidity and provide comfort throughout the year.

### PM motors

*Ultra Premium* efficiency IE5 class PM fan motors minimize power consumption and ensure durability of the unit.

### Energy saving technologies

Units are equipped with the most efficient and advanced technical solutions: high efficiency PM/EC fans of Ultra and Premium classes, non-freezing condensing and sorption rotary heat exchangers, high efficiency counter flow heat exchangers, high surface area air filters. All of these solutions greatly reduce operational costs and shorten payback time.

### Eurovent certified

VERSO units are tested on a regular basis at the Eurovent climatic laboratory in Germany. Parameters such as performance, efficiency, noise level, tolerances and other are tested.



### Integrated control system C5

Automatic system designed for professionals, controls thermodynamic processes and saves energy.

The user is given detailed information about the operation of the unit. A variety of modes and functions allows the user to choose the optimal operating mode that maximizes energy saving. For user convenience, the operation of the air handling units can be controlled not only with the control panel, but also via the Internet or BMS.

### Integrated web server

The units can be controlled not only with the control panel, but also remotely via a web browser on your computer or mobile devices.

### Integration to BMS

All KOMFOVENT air handling units have fully implemented Modbus and BACnet protocols, which allows seamless integration with any desired Building Management Systems.



## Wide range

VERSO units are designed for efficient ventilation and are suitable for various types of projects. You can choose a unified unit from the VERSO Standard series, or VERSO Pro which can be specifically tailored to meet your requirements. Large number of configurations (vertical, horizontal, flat and universal type, with rotary or plate heat exchangers) allow you to always select optimal and most efficient solution.



**Verso R**  
units with a rotary heat exchanger



**Verso CF**  
units with a counterflow plate heat exchanger



**Verso P**  
units with a plate heat exchanger



**Verso S**  
supply air units

## VERSO Standard



800 – 8000 m<sup>3</sup>/h

- ✓ Vertical, horizontal, flat or universal application
- ✓ Compact design
- ✓ Models for REVIT software

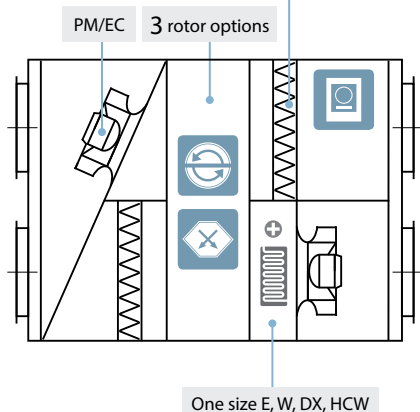

## VERSO Pro

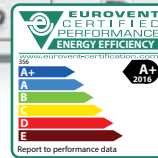

1000 – 40 000 m<sup>3</sup>/h

- ✓ 10 basic sizes for various combinations
- ✓ Professionally convenient software
- ✓ Selection of desired heat exchanger, fan, heater/cooler
- ✓ Revit models

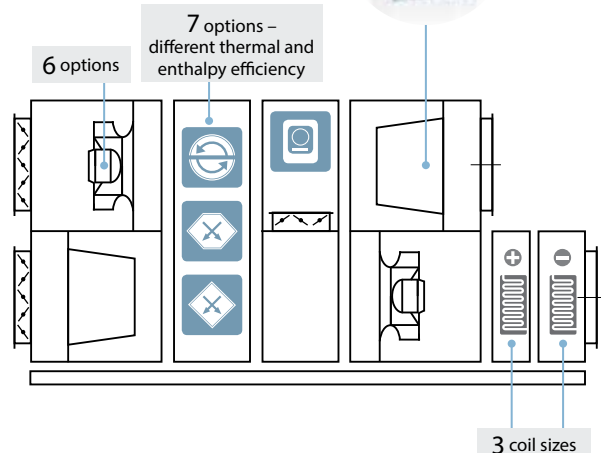



# VERSO Standard



## VERSO R Standard

A wide selection of compact units with non-freezing rotary heat exchanger, horizontal, vertical, universal and false ceiling ducts connection.

VERSO R Standard units efficiently save energy all year round by significantly reducing both heating and air conditioning costs. Ideal for cold weather countries.

Sorption rotary heat exchangers maintain optimal microclimate in the premises.

Sizes and capacities of Verso R units

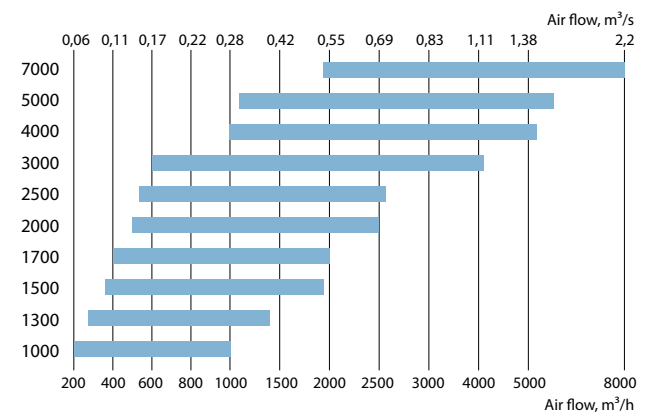

## VERSO CF Standard

A wide selection of compact units with counterflow plate heat exchanger, horizontal, vertical, universal and false ceiling ducts connection.

VERSO CF Standard units efficiently save energy all year round by significantly reducing both heating and air conditioning costs. Ideal for mild and warm climate countries.

Enthalpy heat exchanger with a special patented membrane ensures optimal microclimate – the air is humidified in the winter and dehumidified in the summer.

Sizes and capacities of Verso CF units

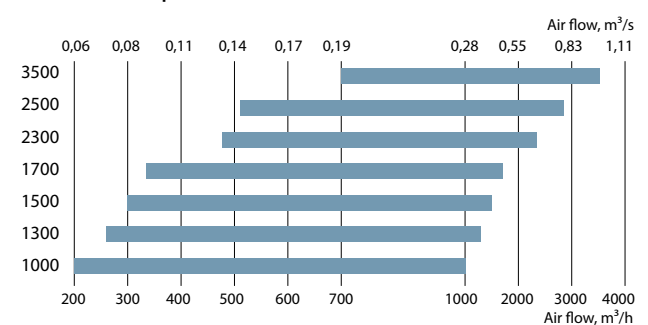

## VERSO S Standard

Low-height false ceiling supply air handling units are easily installed even in the smallest premises.

All VERSO S Standard units have integrated control system, which simplifies units' installation.

Sizes and capacities of Verso S units

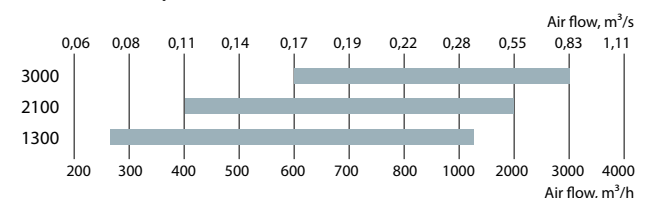

# VERSO Standard U features

## Universal design – 14 duct connections options

The ducts can be connected in the optimal way and installation space saved due to universal design of VERSO Standard U.

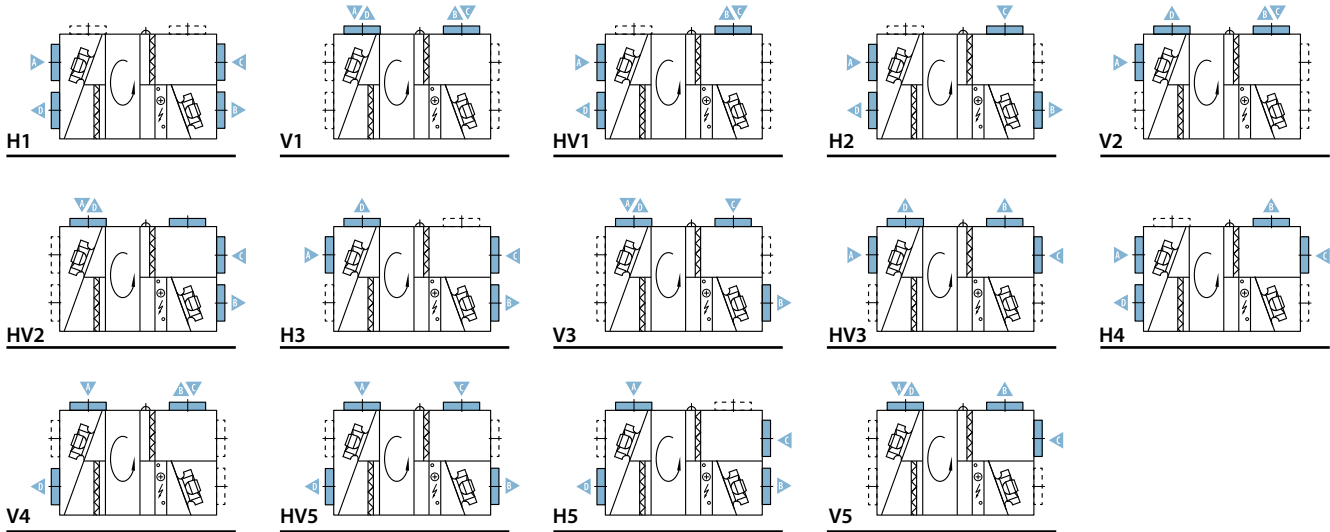

## Integrated DX coil

- All VERSO Standard units of the universal type can be ordered with integrated DX coil.
- Extremely economical air heating even at very low outdoor temperatures.
- Cooling/heating power control.
- Wide range of inverter outdoor units.

## Sorption rotary heat exchanger

- Sorption rotary heat exchanger controls the humidity in the premises more efficiently than a condensing rotor. Now sorption is an available option for all VERSO R Standard units.
- The humidity from exhaust air is used to humidify the outdoor air in winter.
- Wet outdoor air in summertime is dried.
- High comfort is ensured all year long.

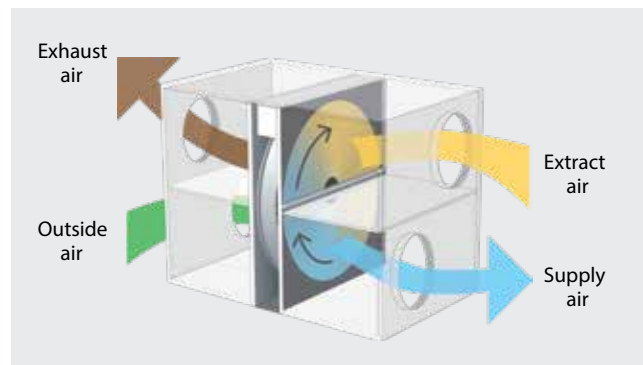
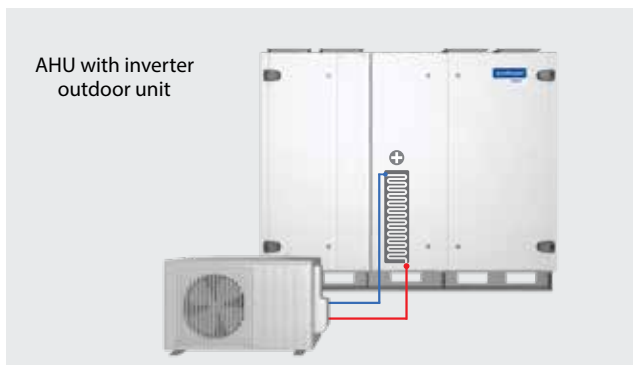

# VERSO R Standard

## Air handling units with rotary heat exchanger

### Sizes and capacities of Verso R units

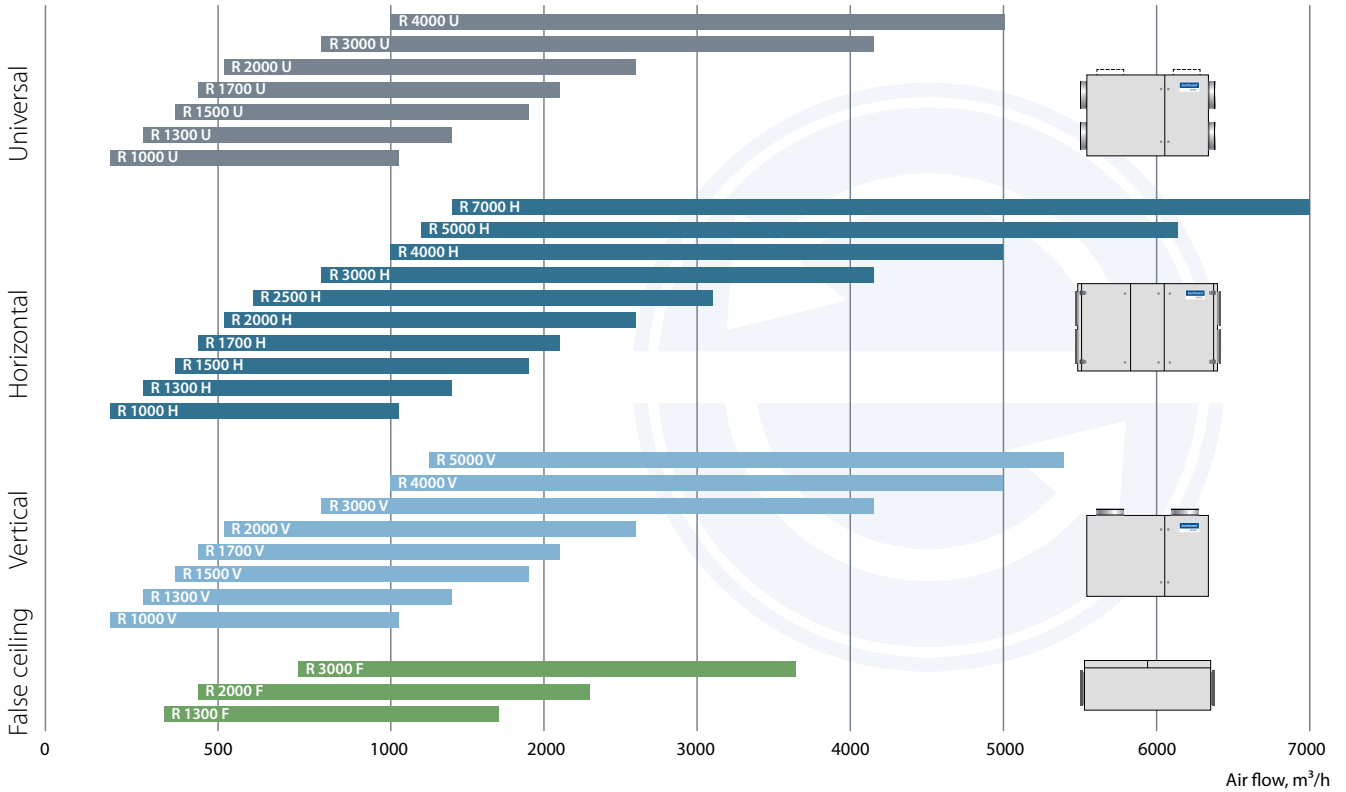

### Modifications of VERSO R Standard units

Unit	Heat exchanger			Supply/exhaust air filter class		Heater			Cooler		Inspection side				Control system C5 panel C5.1
	L/A	SL/A	L/AZ	F7	M5	HE	HW	HCV	CW	DX	R1	L1	R2	L2	
Verso R 1000 U	●	○	○	●	●	○		○	△	○	○	○			●
Verso R 1000 H/V	●	○	○	●	●	○	○		△	△	○	○			●
Verso R 1300 U	●	○	○	●	●	○		○	△	○	○	○			●
Verso R 1300 H/V	●	○	○	●	●	○	○		△	△	○	○			●
Verso R 1300 F	●	○	○	●	●	●	△	△	△	△	○	○			●
Verso R 1500 U	●	○	○	●	●	○		○	△	○	○	○			●
Verso R 1500 H/V	●	○	○	●	●	○	○		△	△	○	○			●
Verso R 1700 U	●	○	○	●	●	○		○	△	○	○	○			●
Verso R 1700 H/V	●	○	○	●	●	○	○		△	△	○	○			●
Verso R 2000 U	●	○	○	●	●	○		○	△	○	○	○			●
Verso R 2000 H/V	●	○	○	●	●	○	○		△	△	○	○			●
Verso R 2000 F	○	●		●	●	●	△	△	△	△	○	○			●
Verso R 2500 H	●	○	○	●	●	○	○		△	△	○	○	○	○	●
Verso R 3000 U	●	○	○	●	●	○		○	△	○	○	○			●
Verso R 3000 H/V	●	○	○	●	●	○	○		△	△	○	○			●
Verso R 3000 F	○	●		●	●	●	△		△	△	○	○			●
Verso R 4000 U	●	○	○	●	●	○		○	△	○	○	○			●
Verso R 4000 H/V	●	○	○	●	●	○	○		△	△	○	○			●
Verso R 5000 V	○	●	○	●	●	○	○			○	○	○			●
Verso R 5000 H	●	○	○	●	●		●		△	△	○	○	○	○	●
Verso R 7000 H	●	○	○	●	●		●		△	△	○	○			●

● standard equipment      ○ possible choice      △ ordered separately duct heater/cooler

The markings are explained on p. 7.

# Verso R 1000 U/H/V

Nominal air flow according to ErP 2018, m <sup>3</sup> /h	920
Panel thickness, mm	50
Unit weight, kg	196
Supply voltage HE, V	3~400
Supply voltage HW, V	1~230
Maximal operating current HE, A	7,3
Maximal operating current HW, A	3,3
Filters dimensions BxHxL, mm	800x400x46
Electric power input of the fan drive at maximum flow rate, W	180
Electric air heater capacity, kW / Δt, °C	3 / 9,1
Control panel	C5.1
Maintenance space, mm	800



The photo is intended for informational purposes only. exact details may vary.

## Acoustic data

A-weighted sound power level  $L_{WA}$ , dB(A) at nominal flow rate

Supply inlet	58
Supply outlet	72
Exhaust inlet	59
Exhaust outlet	70
Casing	52

A-weighted sound pressure level  $L_{pA}$ , dB(A)

10 m<sup>2</sup> normally isolated room, distance from casing – 3 m.

Surroundings	41
--------------	----

## Performance (Verso R 1000 UH data)

Supply air filter F7, exhaust air filter M5

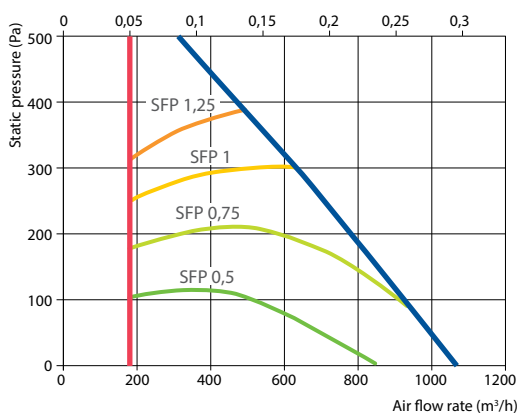

## Accessories (p. 120)

Closing damper	AGUJ-M-315+LF24/LM24
Silencer	A/D AGS-315-100-900-M
	B/C AGS-315-100-1200-M
PPU	PPU-HW-3R-15-0,63-W1
Water cooler	DCW-0,9-6
2-way valve	VVP47.15-2,5+SSP61
DX cooler	DCF-0,9-6
Cooling unit	MOU-18HFN6-KA8243

## Temperature efficiency

Outside temperature, °C	Winter					Summer		
	-23	-15	-10	-5	0	25	30	35
After heat exchanger, °C	13,9	15,3	16,2	17,1	18,0	22,5	23,4	24,3

indoor +22°C, 20% RH

## Changeover water/ DX heating – cooling exchanger (HCW/HCDX)

	Winter		Summer	
	Water temperature in/out, °C	Condensation/evaporation T, °C	Capacity, kW	Maximal capacity, kW
Water temperature in/out, °C	60/40	7/12	–	–
Condensation/evaporation T, °C	–	–	45	45/5
Capacity, kW	2,4	5,1	2,4	6,4
Maximal capacity, kW	5,5	6,7	5,5	9,3
Pressure drop, kPa	1,6	4,9	–	–
Air temperature in/out, °C	13,9/22	30/18	13,9/22	30/18
Connection, " / mm	¾		½ / 22	

Summer: 30°C / 50%; HCW – 899 m<sup>3</sup>/h.

## Shown as right (R1)

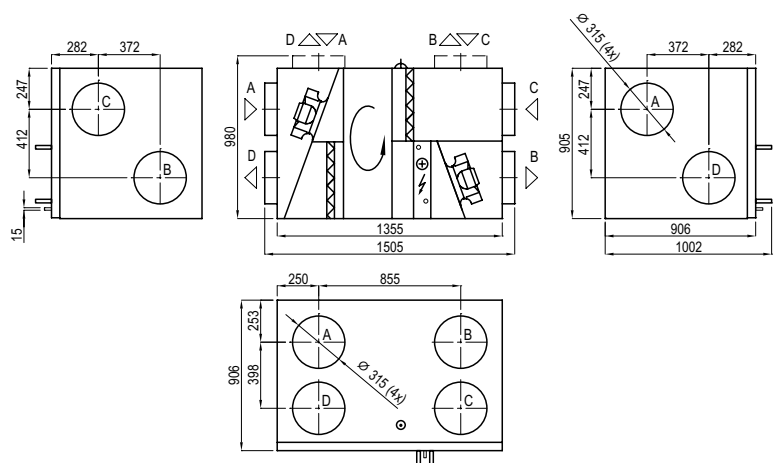

## Shown as left (L1)

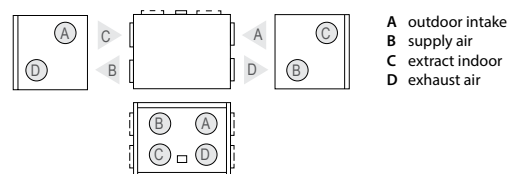

# Verso R 1300 U/H/V

Nominal air flow according to ErP 2018, m <sup>3</sup> /h	1380
Panel thickness, mm	50
Unit weight, kg	203
Supply voltage HE, V	3~400
Supply voltage HW, V	1~230
Maximal operating current HE, A	11,7
Maximal operating current HW, A	5,5
Filters dimensions BxHxL, mm	800x400x46
Electric power input of the fan drive at maximum flow rate, W	270
Electric air heater capacity, kW / Δt, °C	4,5 / 9,1
Control panel	C5.1
Maintenance space, mm	800



The photo is intended for informational purposes only. exact details may vary.

### Acoustic data

#### A-weighted sound power level L<sub>wa</sub>, dB(A) at nominal flow rate

Supply inlet	66
Supply outlet	82
Exhaust inlet	67
Exhaust outlet	79
Casing	58

#### A-weighted sound pressure level L<sub>pa</sub>, dB(A)

10 m<sup>2</sup> normally isolated room, distance from casing – 3 m.

Surroundings	48
--------------	----

### Performance (Verso R 1300 UH data)

Supply air filter F7, exhaust air filter M5

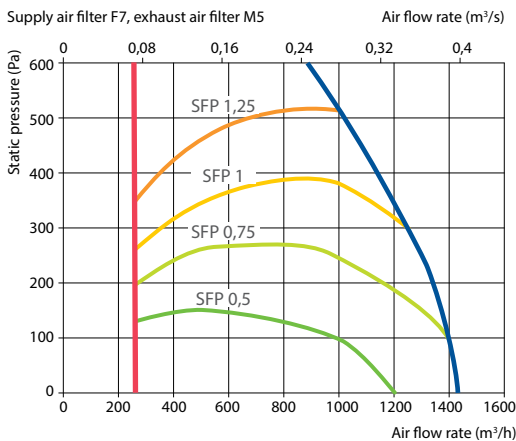

### Temperature efficiency

Outside temperature, °C	Winter					Summer		
	-23	-15	-10	-5	0	25	30	35
After heat exchanger, °C	12,7	14,3	15,4	16,4	17,4	22,6	23,7	24,7

indoor +22°C, 20% RH

### Changeover water/ DX heating – cooling exchanger (HCW/HCDX)

	Winter		Summer	
	Water temperature in/out, °C	Condensation/evaporation T, °C	Capacity, kW	Maximal capacity, kW
Water temperature in/out, °C	60/40	7/12	–	–
Condensation/evaporation T, °C	–	–	45	45/5
Capacity, kW	4,2	7,9	9,6	4,3
Maximal capacity, kW	9,8	8,9	12,0	7,5
Pressure drop, kPa	1,7	9,5	–	–
Air temperature in/out, °C	12,7 / 22	30 / 18	12,7 / 22	30 / 18
Connection, " / mm	¾		½ / 22	

Summer: +30°C/ 50%; HCW – 1350 m<sup>3</sup>/h

### Shown as right (R1)

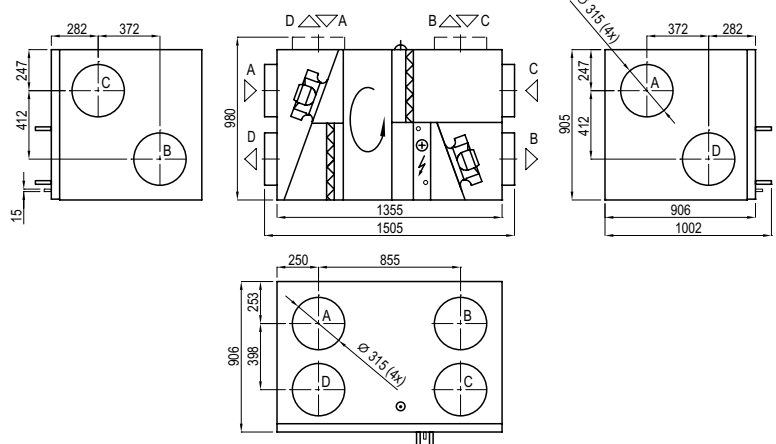

### Shown as left (L1)

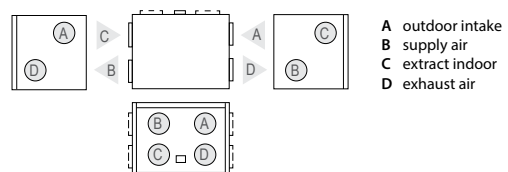

### Accessories (p. 120)

Closing damper	AGUJ-M-315+LF24/LM24
Silencer	A/D AGS-315-100-900-M
	B/C AGS-315-100-1200-M
PPU	PPU-HW-3R-15-1-W2
Water cooler	DCW-1,2-8
2-way valve	VVP45.20-4.0+SSB61
DX cooler	DCF-1,2-8
Cooling unit	MOU-36HFN6-KA8243

# Verso R 1300 F

Nominal air flow according to ErP 2018, m <sup>3</sup> /h	1200
Panel thickness, mm	50
Unit weight, kg	144
Supply voltage HE, V	3~400
Supply voltage HW, V	1~230
Maximal operating current HE, A	10,7
Maximal operating current HW, A	6,7
Filters dimensions BxHxL, mm	410x420x46
Electric power input of the fan drive at maximum flow rate, W	370
Electric air heater capacity, kW / Δt, °C	3 / 5,4
Control panel	C5.1
Maintenance space, mm	400



The photo is intended for informational purposes only. exact details may vary.

## Acoustic data

A-weighted sound power level  $L_{WA}$ , dB(A) at nominal flow rate

Supply inlet	64
Supply outlet	73
Exhaust inlet	63
Exhaust outlet	72
Casing	54

A-weighted sound pressure level  $L_{PA}$ , dB(A)

10 m<sup>2</sup> normally isolated room, distance from casing – 3 m.

Surroundings	44
--------------	----

## Performance

Supply air filter F7, exhaust air filter M5

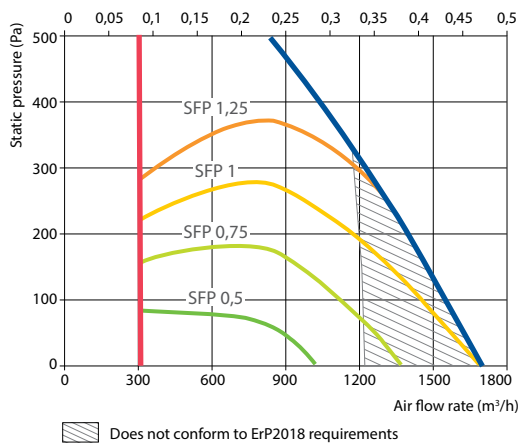

## Temperature efficiency

Outside temperature, °C	Winter					Summer		
	-23	-15	-10	-5	0	25	30	35
After heat exchanger, °C	10,0	12,1	13,5	14,8	16,1	22,8	24,1	25,5

indoor +22°C, 20% RH

## Hot water duct air heater (DH)\*

Water temperature in/out, °C	Winter		
	80/60	70/50	60/40
Capacity, kW	4,8	4,8	4,8
Flow rate, dm <sup>3</sup> /h	214	213	212
Pressure drop, kPa	10,9	11,0	11
Temperature in/out, °C	10,0 / 22,0		
Maximal capacity, kW	12,4	10,2	8,0
Connection, "	½		

\* option

## Shown as right (R1)

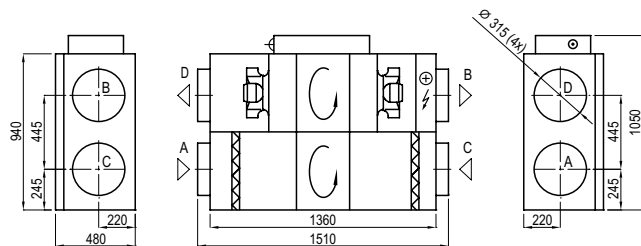

## Shown as left (L1)

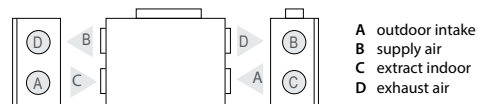

## Accessories (p. 120)

Closing damper	AGUJ-M-315-LF24/LM24
Silencer	A/D AGS-315-100-900-M
	B/C AGS-315-100-1200-M
Water heater	DH-315
PPU	PPU-HW-3R-15-1-W2
Air heater-cooler	DCW-1,2-8 / DHCW-315
2-way valve	VVP47.15-2,5+SSP61
DX cooler	DCF-1,2-8
Cooling unit	MOU-24HFN6-KA8243



# Verso R 1500 U/H/V

Nominal air flow according to ErP 2018, m <sup>3</sup> /h	1530
Panel thickness, mm	50
Unit weight, kg	206
Supply voltage HE, V	3~400
Supply voltage HW, V	1~230
Maximal operating current HE, A	12,9
Maximal operating current HW, A	6,7
Filters dimensions BxHxL, mm	800x400x46
Electric power input of the fan drive at maximum flow rate, W	450
Electric air heater capacity, kW / Δt, °C	4,5 / 6,9
Control panel	C5.1
Maintenance space, mm	800



The photo is intended for informational purposes only. exact details may vary.

### Acoustic data

#### A-weighted sound power level $L_{w,ar}$ dB(A) at nominal flow rate

Supply inlet	60
Supply outlet	75
Exhaust inlet	60
Exhaust outlet	71
Casing	54

#### A-weighted sound pressure level $L_{p,ar}$ dB(A)

10 m<sup>2</sup> normally isolated room, distance from casing – 3 m.

Surroundings	44
--------------	----

### Performance (Verso R 1500 UH data)

Supply air filter F7, exhaust air filter M5

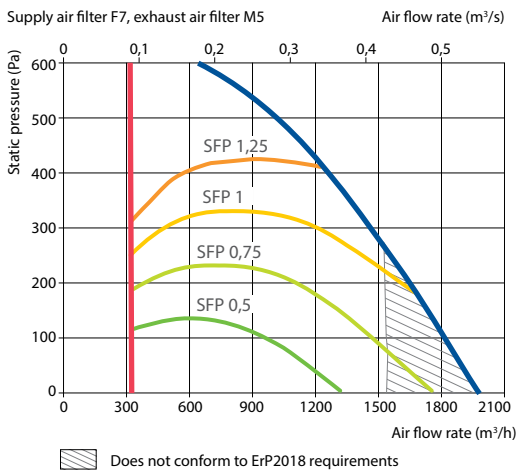

### Temperature efficiency

Outside temperature, °C	Winter					Summer		
	-23	-15	-10	-5	0	25	30	35
After heat exchanger, °C	12,3	14,0	15,1	16,2	17,2	22,6	23,7	24,8

indoor +22°C, 20% RH

### Changeover water/ DX heating – cooling exchanger (HCW/HCDX)

	Winter		Summer	
	Winter	Summer	Winter	Summer
Water temperature in/out, °C	60/40	7/12	–	–
Condensation/evaporation T, °C	–	–	45	45/5
Capacity, kW	5,0	9,1	5,3	10,4
Maximal capacity, kW	10,9	9,7	8,2	12,6
Pressure drop, kPa	1,7	11,8	–	–
Air temperature in/out, °C	12,3 / 22	30 / 18,1	12,3 / 22	30 / 18
Connection, " / mm	¾		½ / 22	

Summer: +30°C/ 50%; DX – 1500 m<sup>3</sup>/h

### Shown as right (R1)

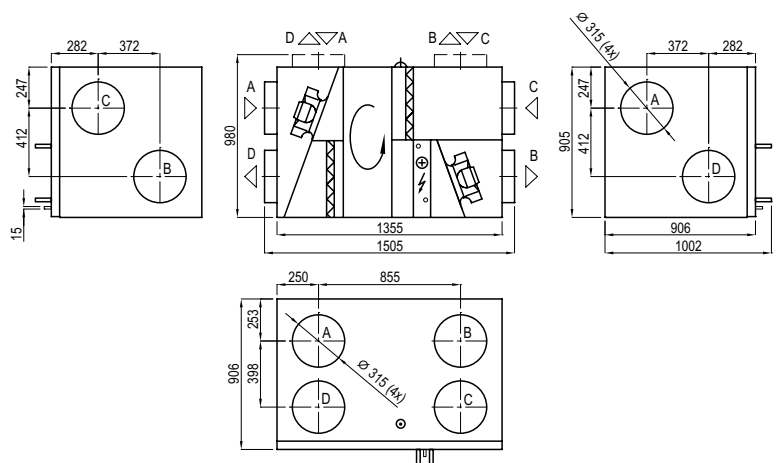

### Shown as left (L1)

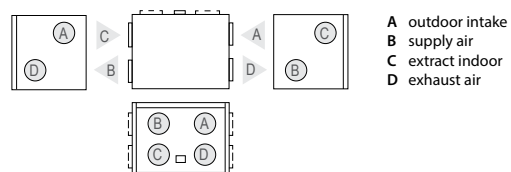

### Accessories (p. 120)

Closing damper	AGUJ-M-315+LF24/LM24
Silencer	A/D AGS-315-100-900-M
	B/C AGS-315-100-1200-M
PPU	PPU-HW-3R-15-1,6-W2
Water cooler	DCW-1,4-9
2-way valve	VVP47.20-4,0+SSP61
DX cooler	DCF-1,4-10
Cooling unit	MOU-36HFN6-KA8243

# Verso R 1700 U/H/V

Nominal air flow according to ErP 2018, m <sup>3</sup> /h	1780
Panel thickness, mm	50
Unit weight, kg	220
Supply voltage HE, V	3~400
Supply voltage HW, V	1~230
Maximal operating current HE, A	12,9
Maximal operating current HW, A	6,7
Filters dimensions BxHxL, mm	800x450x46
Electric power input of the fan drive at maximum flow rate, W	470
Electric air heater capacity, kW / Δt, °C	4,5 / 6,2
Control panel	C5.1
Maintenance space, mm	800



The photo is intended for informational purposes only. exact details may vary.

## Acoustic data

A-weighted sound power level L<sub>WA</sub>, dB(A) at nominal flow rate

Supply inlet	61
Supply outlet	76
Exhaust inlet	61
Exhaust outlet	73
Casing	55

A-weighted sound pressure level L<sub>PA</sub>, dB(A)

10 m<sup>2</sup> normally isolated room, distance from casing – 3 m.

Surroundings	45
--------------	----

## Performance (Verso R 1700 UH data)

Supply air filter F7, exhaust air filter M5

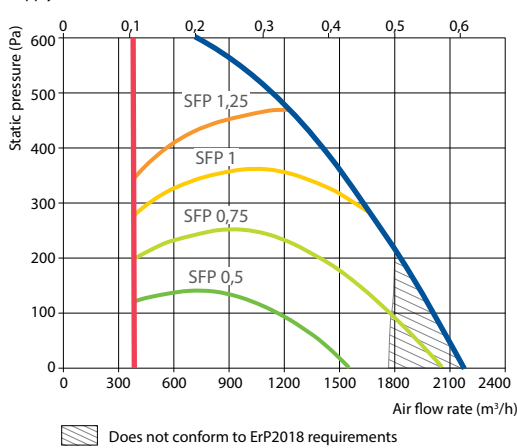

## Temperature efficiency

Outside temperature, °C	Winter					Summer		
	-23	-15	-10	-5	0	25	30	35
After heat exchanger, °C	11,5	13,4	14,6	15,7	16,9	22,7	23,9	25,0

indoor +22°C, 20% RH

## Changeover water/ DX heating – cooling exchanger (HCW/HCDX)

	Winter		Summer	
	Winter	Summer	Winter	Summer
Water temperature in/out, °C	60/40	7/12	-	-
Condensation/evaporation T, °C	-	-	45	45/5
Capacity, kW	6,3	10,4	6,3	12,3
Maximal capacity, kW	13,1	11,4	8,9	14,7
Pressure drop, kPa	1,6	6,9	-	-
Air temperature in/out, °C	11,5 / 22	30 / 18	11,5 / 22	30 / 18
Connection, " / mm	1		5/8 / 22	

Summer: +30°C / 50%

## Shown as right (R1)

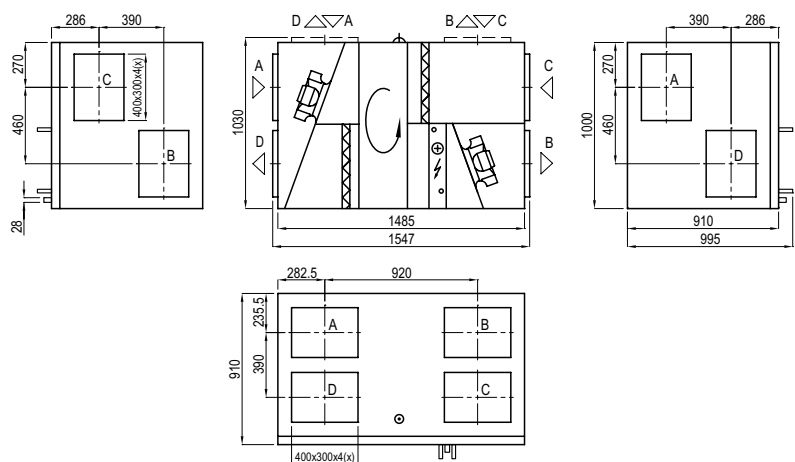

## Shown as left (L1)

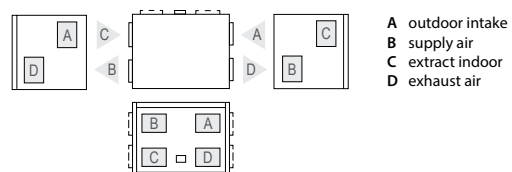

## Accessories (p. 120)

Closing damper	H	SRU-M-300x400+LF24/LM24
	V	SRU-M-400x300+LF24/LM24
Silencer	A/D	STS-IVR3BA-600-300-700-S
	B/C	STS-IVR3BA-600-300-1250-S
PPU		PPU-HW-3R-15-1,6-W2
Air heater-cooler		DCW-1,6-11
2-way valve		VVP47.20-4,0+SSP61
DX cooler		DCF-1,6-11
Cooling unit		MOU-36HFN6-KA8243

# Verso R 2000 U/H/V

Nominal air flow according to ErP 2018, m <sup>3</sup> /h	2170
Panel thickness, mm	50
Unit weight, kg	210
Supply voltage HE, V	3~400
Supply voltage HW, V	1~230
Maximal operating current HE, A	16,9
Maximal operating current HW, A	6,3
Filters dimensions BxHxL, mm	800x450x46
Electric power input of the fan drive at maximum flow rate, W	650
Electric air heater capacity, kW / Δt, °C	7,5 / 8,0
Control panel	C5.1
Maintenance space, mm	800



The photo is intended for informational purposes only. exact details may vary.

### Acoustic data

#### A-weighted sound power level L<sub>war</sub>, dB(A) at nominal flow rate

Supply inlet	64
Supply outlet	79
Exhaust inlet	64
Exhaust outlet	76
Casing	56

#### A-weighted sound pressure level L<sub>par</sub>, dB(A)

10 m<sup>2</sup> normally isolated room, distance from casing – 3 m.

Surroundings	46
--------------	----

### Performance (Verso R 2000 UH data)

Supply air filter F7, exhaust air filter M5

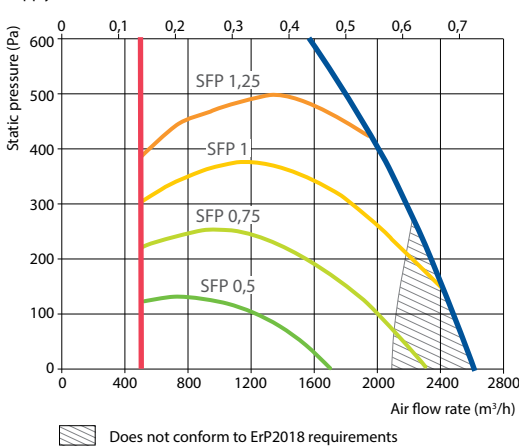

### Temperature efficiency

	Winter					Summer		
Outside temperature, °C	-23	-15	-10	-5	0	25	30	35
After heat exchanger, °C	10,3	12,4	13,7	15,0	16,3	22,8	24,1	25,4

indoor +22°C, 20% RH

### Changeover water/ DX heating – cooling exchanger (HCW/HCDX)

	Winter	Summer	Winter	Summer
Water temperature in/out, °C	60/40	7/12		
Condensation/evaporation T, °C	–	–	45	45/5
Capacity, kW	8,5	12,9	7,7	12,5
Maximal capacity, kW	15,9	12,9	9,6	14,8
Pressure drop, kPa	1,8	9,5	–	–
Air temperature in/out, °C	10,3 / 22	30 / 18,5	9,2 / 22	30 / 18
Connection, " / mm		1		5/8 / 22

Summer +30°C/ 50%; DX – 1800 m<sup>3</sup>/h

### Shown as right (R1)

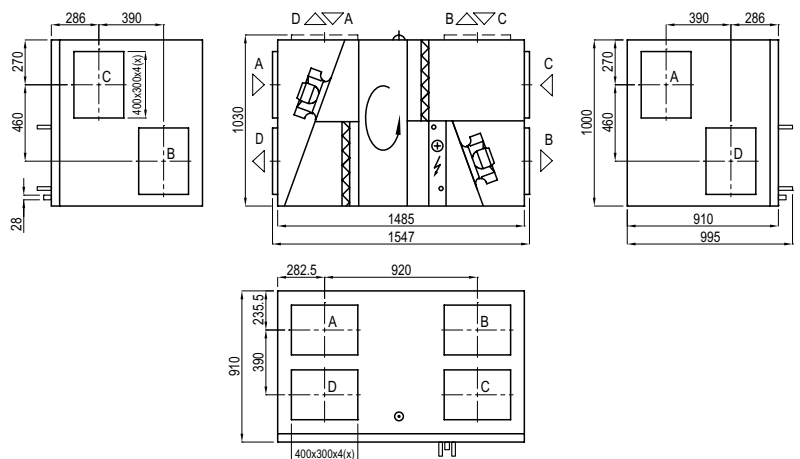

### Shown as left (L1)

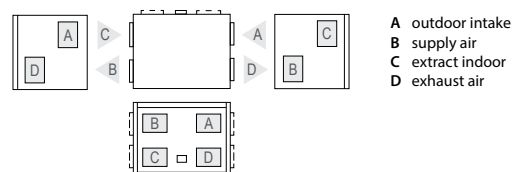

### Accessories (p. 120)

Closing damper	H	SRU-M-300x400+LF24/LM24
	V	SRU-M-400x300+LF24/LM24
Silencer	A/D	STS-IVR3BA-600-400-700-S
	B/C	STS-IVR3BA-600-400-1250-S
PPU		PPU-HW-3R-15-2,5-W2
Air heater-cooler		DCW-2,5-17
2-way valve		VVP45.25-6,3+SSB61
DX cooler		DCF-2,5-17
Cooling unit		MOU-55HFN6-KA8243

# Verso R 2000 F

Nominal air flow according to ErP 2018, m <sup>3</sup> /h	2000
Panel thickness, mm	50
Unit weight, kg	280
Supply voltage HE, V	3~400
Supply voltage HW, V	1~230
Maximal operating current HE, A	16,8
Maximal operating current HW, A	6,3
Filters dimensions BxHxL, mm	560x420x96
Electric power input of the fan drive at maximum flow rate, W	665
Electric air heater capacity, kW / Δt, °C	7,5/8,9
Control panel	C5.1
Maintenance space, mm	400



The photo is intended for informational purposes only. exact details may vary.

## Acoustic data

A-weighted sound power level  $L_{WA}$ , dB(A) at nominal flow rate

Supply inlet	69
Supply outlet	78
Exhaust inlet	68
Exhaust outlet	78
Casing	58

A-weighted sound pressure level  $L_{PA}$ , dB(A)

10 m<sup>2</sup> normally isolated room, distance from casing – 3 m.

Surroundings	47
--------------	----

## Performance

Supply air filter F7, exhaust air filter M5

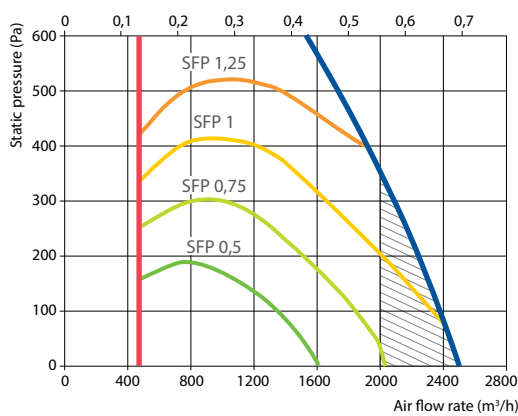

Does not conform to ErP2018 requirements

## Temperature efficiency

Outside temperature, °C	Winter					Summer		
	-23	-15	-10	-5	0	25	30	35
After heat exchanger, °C	15,0	16,3	17,1	17,8	18,6	22,5	23,2	24,0

indoor +22°C, 20% RH

## Hot water duct air heater (DH)\*

Water temperature in/out, °C	Winter		
	80/60	70/50	60/40
Capacity, kW	4,7	4,7	4,7
Flow rate, dm <sup>3</sup> /h	208	207	206
Pressure drop, kPa	11,0	11,1	11,2
Temperature in/out, °C	15/22		
Maximal capacity, kW	16,70	13,5	10,3
Connection, "	1/2		

\* option

## Shown as right (R1)

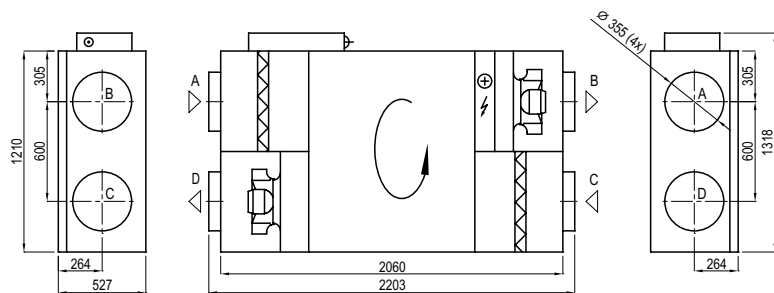

## Shown as left (L1)

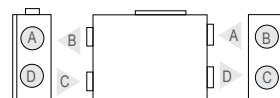

- A outdoor intake
- B supply air
- C extract indoor
- D exhaust air

## Accessories (p. 120)

Closing damper	AGUJ-M-355+LF24/LM24
Silencer	A/D AGS-355-100-900-M
	B/C AGS-355-100-1200-M
Water heater	DH-355
PPU	PPU-HW-3R-15-1-W2
Air heater-cooler	DCW-2,0-13/ DHCW-355
2-way valve	VVP47.20-4,0+SSP61
DX cooler	DCF-2,0-14
Cooling unit	MOU-48HFN6-KA8243

# Verso R 2500 H

Nominal air flow according to ErP 2018, m <sup>3</sup> /h	2800
Panel thickness, mm	50
Unit weight, kg	289
Supply voltage HE, V	3~400
Supply voltage HW, V	1~230
Maximal operating current HE, A	22
Maximal operating current HW, A	11,7
Filters dimensions BxHxL, mm	792x392-10x500
Electric power input of the fan drive at maximum flow rate, W	520
Electric air heater capacity, kW / Δt, °C	7,5/7,4
Control panel	C5.1
Maintenance space, mm	900



The photo is intended for informational purposes only. exact details may vary.

### Acoustic data

A-weighted sound power level  $L_{WA}$ , dB(A) at nominal flow rate

Supply inlet	58
Supply outlet	76
Exhaust inlet	61
Exhaust outlet	72
Casing	59

A-weighted sound pressure level  $L_{pA}$ , dB(A)

10 m<sup>2</sup> normally isolated room, distance from casing – 3 m.

Surroundings	45
--------------	----

### Performance

Supply air filter F7, exhaust air filter M5 Air flow rate (m<sup>3</sup>/s)

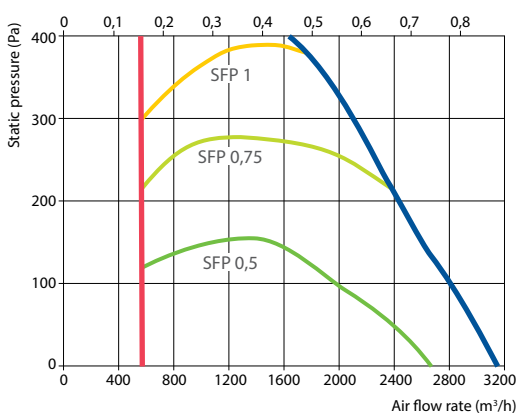

### Temperature efficiency

Outside temperature, °C	Winter					Summer		
	-23	-15	-10	-5	0	25	30	35
After heat exchanger, °C	10,4	12,5	13,7	15,0	16,3	22,8	24,1	25,4

indoor +22°C, 20% RH

### Hot water air heater

	Winter		
	80/60	70/50	60/40
Capacity, kW	10,9	10,9	10,9
Flow rate, dm <sup>3</sup> /h	481	479	477
Pressure drop, kPa	3,3	3,3	3,3
Temperature in/out, °C	10,4/22		
Maximal capacity, kW	22,1	17,7	13,2
Connection, "	½		

### Shown as right (R2)

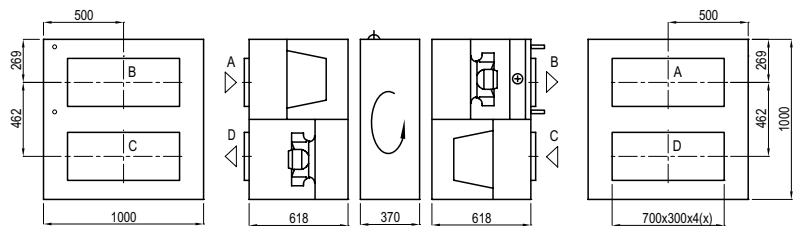

### Shown as left (L2)

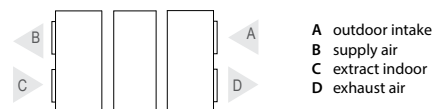

### Accessories (p. 120)

Closing damper	SRU-M-700x300+LF24/LM24
Silencer	A/D STS-IVR3BA-800-300-700-S
	B/C STS-IVR3BA-800-300-1250-S
PPU	PPU-HW-3R-15-2,5-W2
Air heater-cooler	DCW-2,5-17
2-way valve	VVP45.25-6.3
DX cooler	DCF-2,5-17
Cooling unit	MOU-55HFN6-KA8243

# Verso R 3000 U/H/V

Nominal air flow according to ErP 2018, m <sup>3</sup> /h	3450
Panel thickness, mm	50
Unit weight, kg	456
Supply voltage HE, V	3~400
Supply voltage HW, V	3~400
Maximal operating current HE, A	19,8
Maximal operating current HW, A	7,1
Filters dimensions BxHxL, mm	525x510x46
Electric power input of the fan drive at maximum flow rate, W	850
Electric air heater capacity, kW / Δt, °C	9/6,6
Control panel	C5.1
Maintenance space, mm	1000



The photo is intended for informational purposes only. exact details may vary.

### Acoustic data

A-weighted sound power level  $L_{WA}$ , dB(A) at nominal flow rate

Supply inlet	59
Supply outlet	76
Exhaust inlet	59
Exhaust outlet	73
Casing	51

A-weighted sound pressure level  $L_{PA}$ , dB(A)

10 m<sup>2</sup> normally isolated room, distance from casing – 3 m.

Surroundings	40
--------------	----

### Performance (Verso R 3000 UH data)

Supply air filter F7, exhaust air filter M5

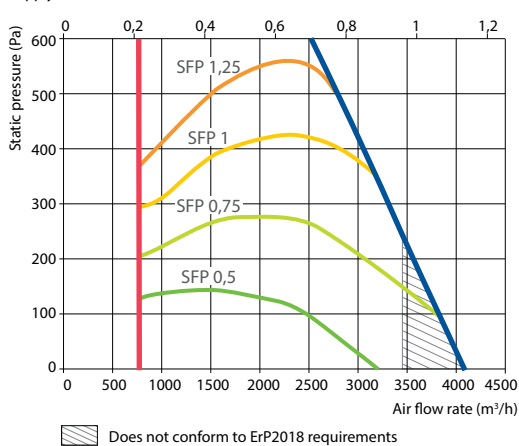

### Temperature efficiency

Outside temperature, °C	Winter					Summer		
	-23	-15	-10	-5	0	25	30	35
After heat exchanger, °C	11,0	13,0	14,2	15,4	16,6	22,7	24,0	25,2

indoor +22°C, 20% RH

### Changeover water/ DX heating – cooling exchanger (HCW/HCDX)

	Winter		Summer	
	Water temperature in/out, °C	Condensation/evaporation T, °C	Capacity, kW	Maximal capacity, kW
Water temperature in/out, °C	60/40	7/12	–	–
Condensation/evaporation T, °C	–	–	45	45/5
Capacity, kW	12,8	21,5	11,5	19,6
Maximal capacity, kW	26,0	21,7	20,4	22,9
Pressure drop, kPa	2,0	20,5	–	–
Air temperature in/out, °C	11,0 / 22	30 / 18,0	11,0 / 22	30 / 18
Connection, " / mm	1		5/8 / 22	

Summer +30°C/ 50%; DX – 2900 m<sup>3</sup>/h

### Shown as right (R1)

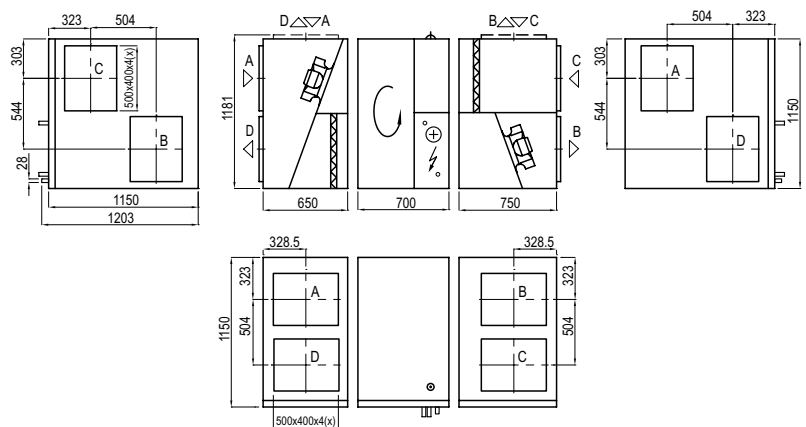

### Shown as left (L1)

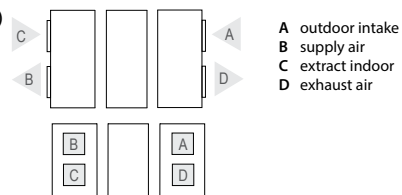

### Accessories (p. 120)

Closing damper	H	SRU-M-400x500+LF24/LM24
	V	SRU-M-500x400+LF24/LM24
Silencer	A/D	STS-IVR3BA-600-500-700-S
	B/C	STS-IVR3BA-600-500-1250-S
PPU		PPU-HW-3R-15-2,5-W2
Air heater-cooler		DCW-3,0-20
2-way valve		VVP45.25-6,3+SSB61
DX cooler		DCF-3,0-20-2
Cooling unit		2xMOU-48HFN6-KA8243

# Verso R 3000 F

Nominal air flow according to ErP 2018, m <sup>3</sup> /h	3440
Panel thickness, mm	50
Unit weight, kg	289
Supply voltage HE, V	3~400
Supply voltage HW, V	3~400
Maximal operating current HE, A	19,9
Maximal operating current HW, A	7,1
Filters dimensions BxHxL, mm	560x540x96
Electric power input of the fan drive at maximum flow rate, W	780
Electric air heater capacity, kW / Δt, °C	9/7,3
Control panel	C5.1
Maintenance space, mm	600



The photo is intended for informational purposes only. exact details may vary.

### Acoustic data

#### A-weighted sound power level L<sub>wa</sub>, dB(A) at nominal flow rate

Supply inlet	72
Supply outlet	85
Exhaust inlet	72
Exhaust outlet	85
Casing	60

#### A-weighted sound pressure level L<sub>pa</sub>, dB(A)

10 m<sup>2</sup> normally isolated room, distance from casing – 3 m.

Surroundings	49
--------------	----

### Performance

Supply air filter F7, exhaust air filter M5

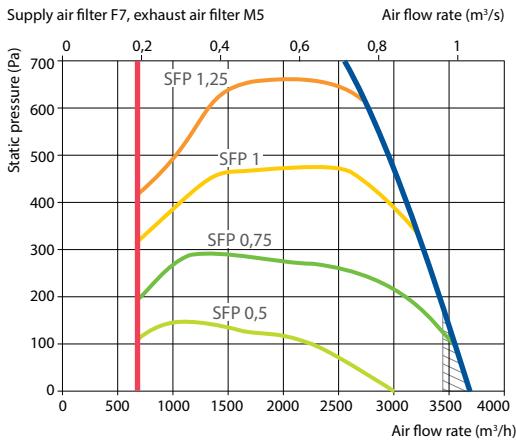

Does not conform to ErP2018 requirements

### Temperature efficiency

Outside temperature, °C	Winter					Summer		
	-23	-15	-10	-5	0	25	30	35
After heat exchanger, °C	12,4	14,1	15,2	16,2	17,3	22,6	23,7	24,8

indoor +22°C, 20% RH

### Hot water air heater (SVK)\*

Water temperature in/out, °C	Winter		
	80/60	70/50	60/40
Capacity, kW	11,1	11,1	11,1
Flow rate, dm <sup>3</sup> /h	493	490	488
Pressure drop, kPa	9,3	9,4	9,5
Temperature in/out, °C	12,4 / 22,0		
Maximal capacity, kW	26,8	21,8	16,7
Connection, "	½		

\* option

### Shown as right (R1)

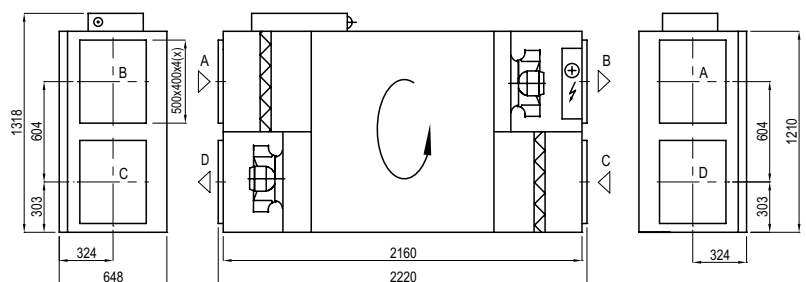

### Shown as left (L1)

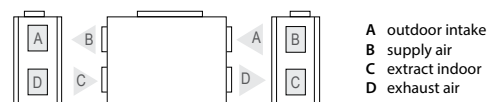

- A outdoor intake
- B supply air
- C extract indoor
- D exhaust air

### Accessories (p. 120)

Closing damper	SRU-M-500x400+LF24/LM24
Silencer	A/D STS-IVR3BA-600-400-700-S
	B/C STS-IVR3BA-600-400-1250-S
Water heater	SVK-700x400-2R
PPU	PPU-HW-3R-15-1.6-W2
Air heater-cooler	DCW-3,0-20
2-way valve	VVP45.25-6.3+SSB61
DX cooler	DCF-3,0-20-2
Cooling unit	2xMOU-36HFN6-KA8243



# Verso R 4000 U/H/V

Nominal air flow according to ErP 2018, m <sup>3</sup> /h	3500
Panel thickness, mm	50
Unit weight, kg	470
Supply voltage HE, V	3~400
Supply voltage HW, V	3~400
Maximal operating current HE, A	31,1
Maximal operating current HW, A	9,7
Filters dimensions BxHxL, mm	525x510x46
Electric power input of the fan drive at maximum flow rate, W	1830
Electric air heater capacity, kW / Δt, °C	15/8,7
Control panel	C5.1
Maintenance space, mm	1000



The photo is intended for informational purposes only. exact details may vary.

## Acoustic data

A-weighted sound power level  $L_{WA}$ , dB(A) at nominal flow rate

Supply inlet	59
Supply outlet	76
Exhaust inlet	59
Exhaust outlet	73
Casing	47

A-weighted sound pressure level  $L_{PA}$ , dB(A)

10 m<sup>2</sup> normally isolated room, distance from casing – 3 m.

Surroundings	36
--------------	----

## Performance (Verso R 4000 UH data)

Supply air filter F7, exhaust air filter M5

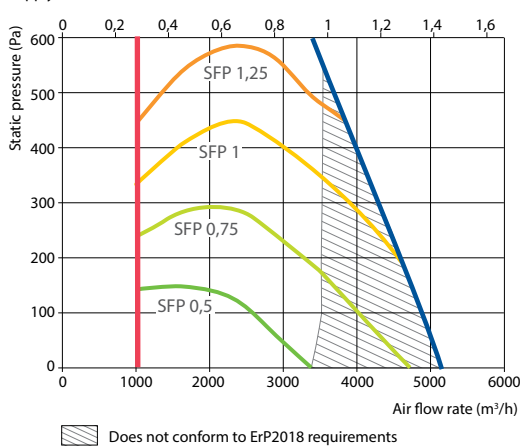

## Temperature efficiency

Outside temperature, °C	Winter					Summer		
	-23	-15	-10	-5	0	25	30	35
After heat exchanger, °C	10,9	12,9	14,1	15,4	16,6	22,7	24,0	25,2

indoor +22°C, 20% RH

## Changeover water/ DX heating – cooling exchanger (HCW/HCDX)

	Winter		Summer	
	Winter	Summer	Winter	Summer
Water temperature in/out, °C	60/40	7/12	-	-
Condensation/evaporation T, °C	-	-	45	45/5
Capacity, kW	13,1	21,7	13,1	24,1
Maximal capacity, kW	26,3	21,8	17,6	26,8
Pressure drop, kPa	2	20,9	-	-
Air temperature in/out, °C	10,9 / 22	30 / 18,0	10,9 / 22	30 / 18,0
Connection, " / mm	1		2x½ / 2x22	

Summer +30°C/ 50%

## Shown as right (R1)

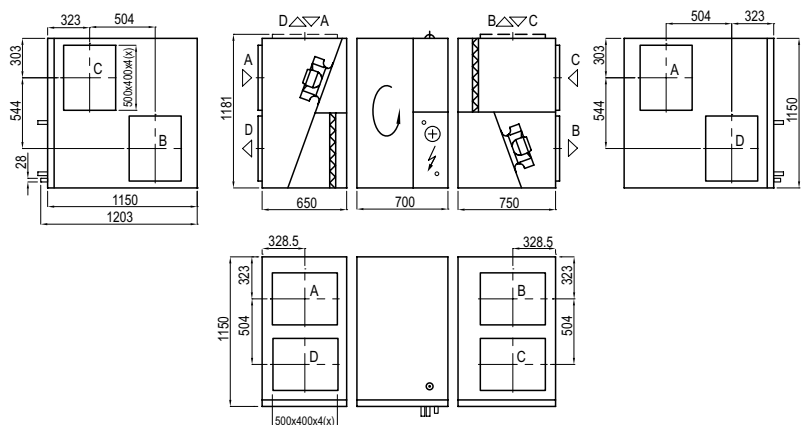

## Shown as left (L1)

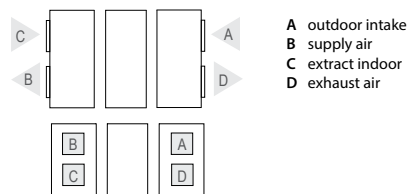

- A outdoor intake
- B supply air
- C extract indoor
- D exhaust air

## Accessories (p. 120)

Closing damper	H	SRU-M-400x500+LF24/LM24
	V	SRU-M-500x400+LF24/LM24
Silencer	A/D	STS-IVR3BA-800-500-700-S
	B/C	STS-IVR3BA-800-500-1250-S
PPU		PPU-HW-3R-25-6.3-W2
Air heater-cooler		DCW-4,5-30
2-way valve		VVP45.25-10+SSC61
DX cooler		DCF-4,5-31-2
Cooling unit		2xMOU-55HFN6-KA8243

# Verso R 5000 V

Nominal air flow according to ErP 2018, m <sup>3</sup> /h	5000
Panel thickness, mm	50
Unit weight, kg	600
Supply voltage HE, V	3~400
Supply voltage HW, V	1~230
Maximal operating current HE, A	29,5
Maximal operating current HW, A	8,1
Filters dimensions BxHxL, mm	650x610x92
Electric power input of the fan drive at maximum flow rate, W	1210
Electric air heater capacity, kW / Δt, °C	15 / 8,3
Control panel	C5.1
Maintenance space, mm	1300

### Acoustic data

#### A-weighted sound power level L<sub>wa</sub>, dB(A) at nominal flow rate

Supply inlet	69,5
Supply outlet	80,1
Exhaust inlet	67,7
Exhaust outlet	82,5
Casing	61,4

#### A-weighted sound pressure level L<sub>pa</sub>, dB(A)

10 m<sup>2</sup> normally isolated room, distance from casing – 3 m.

Surroundings	58,4
--------------	------

### Performance

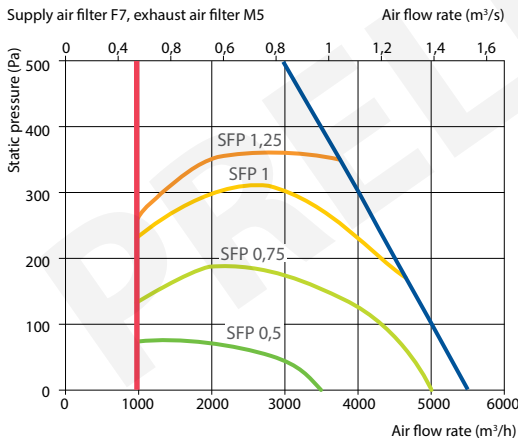

### Accessories (p. 120)

Closing damper	SRU-M-1100x250+LF24/LM24
Silencer	A/D STS-IVR3BA-1100-250-700-S B/C STS-IVR3BA-1100-250-1250-S
PPU	PPU-HW-3R-20-4-W2
Water cooler	DCW-4,5-30
2-way valve	VVP45.25-10.0+SSC61
DX cooler	DCF-4,5-31-2
Cooling unit	2xMOU-55HFN6-KA8243



The photo is intended for informational purposes only. exact details may vary.

### Temperature efficiency

	Winter					Summer		
Outside temperature, °C	-23	-15	-10	-5	0	25	30	35
After heat exchanger, °C	15	16,2	17	17,8	18,6	22,5	23,3	24,0

indoor +22°C, 20% RH

### Changeover water/ DX heating – cooling exchanger (HCW/HCDX)

	Winter	Summer	Winter	Summer
Water temperature in/out, °C	60/40	7/12		
Condensation/evaporation T, °C	–	–	45	45/5
Capacity, kW	11,7	20,8	11,7	35
Maximal capacity, kW	21,1	20,8	23	39
Pressure drop, kPa	10,3	71,6	–	–
Air temperature in/out, °C	15/22	30/21,2	15/22	30/18
Connection, "/ mm		½		¾ / 22

### Shown as right (R1)

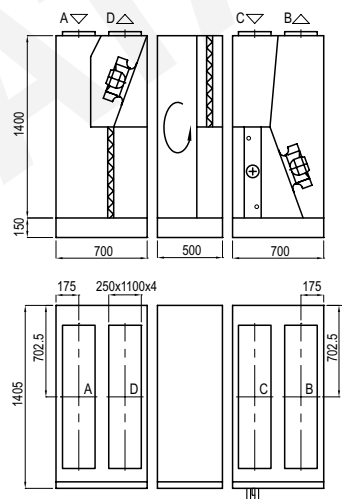

### Shown as left (L1)

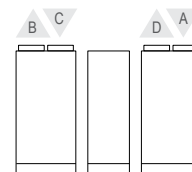

- A outdoor intake
- B supply air
- C extract indoor
- D exhaust air

# Verso R 5000 H

Nominal air flow according to ErP 2018, m <sup>3</sup> /h	5250
Panel thickness, mm	50
Unit weight, kg	442
Supply voltage HE, V	3~400
Maximal operating current HE, A	HW 13,1
Filters dimensions B×H×L, mm	592×592-8×500
Electric power input of the fan drive at maximum flow rate, W	1000
Control panel	C5.1
Maintenance space, mm	1200



The photo is intended for informational purposes only. exact details may vary.

## Acoustic data

A-weighted sound power level  $L_{WA}$ , dB(A)  
at nominal flow rate

Supply inlet	61
Supply outlet	78
Exhaust inlet	64
Exhaust outlet	75
Casing	63

A-weighted sound pressure level  $L_{PA}$ , dB(A)

10 m<sup>2</sup> normally isolated room, distance from casing – 3 m.

Surroundings	50
--------------	----

## Temperature efficiency

Outside temperature, °C	Winter					Summer		
	-23	-15	-10	-5	0	25	30	35
After heat exchanger, °C	10,5	12,6	13,8	15,1	16,4	22,8	24,0	25,3

indoor +22°C, 20% RH

## Hot water air heater

Water temperature in/out, °C	Winter		
	80/60	70/50	60/40
Capacity, kW	20,2	20,2	20,2
Flow rate, dm <sup>3</sup> /h	894	890	881
Pressure drop, kPa	5,3	5,3	5,3
Temperature in/out, °C	10,5 / 22,0	10,5 / 22,0	10,5 / 21,9
Maximal capacity, kW	37,1	29,0	20,1
Connection, "	½		

## Performance

Supply air filter F7, exhaust air filter M5

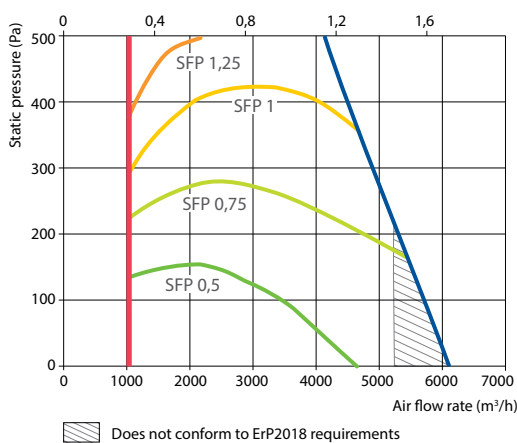

## Shown as right (R1)

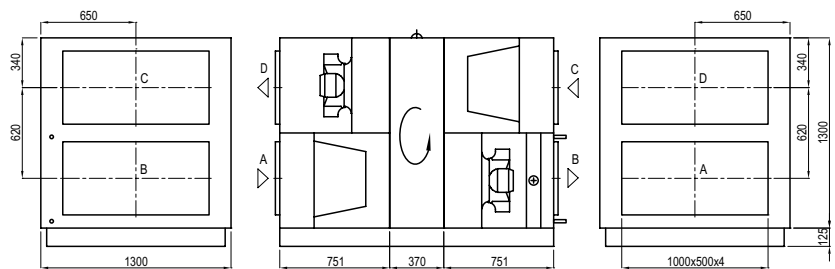

## Shown as left (L1)

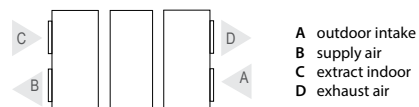

- A outdoor intake
- B supply air
- C extract indoor
- D exhaust air

## Accessories (p. 120)

Closing damper	SRU-M-1000x500+LF24/LM24
Silencer	A/D STS-IVR3BA-1000-500-700-S B/C STS-IVR3BA-1000-500-1250-S
PPU	PPU-HW-3R-20-4,0-W2
Air heater-cooler	DCW-4,5-30
2-way valve	VVP45.25-10.0+SSC61
DX cooler	DCF-4,5-31-2
Cooling unit	2xMOU-55HFN6-KA8243

# Verso R 7000 H

Nominal air flow according to ErP 2018, m <sup>3</sup> /h	6680
Panel thickness, mm	50
Unit weight, kg	765
Supply voltage HE, V	3~400
Maximal operating current HE, A	HW 18,1
Filters dimensions BxHxL, mm	592x592-8x500
Electric power input of the fan drive at maximum flow rate, W	1340
Control panel	C5.1
Maintenance space, mm	1400



The photo is intended for informational purposes only. exact details may vary.

### Acoustic data

#### A-weighted sound power level $L_{w,ar}$ dB(A) at nominal flow rate

Supply inlet	60
Supply outlet	82
Exhaust inlet	64
Exhaust outlet	82
Casing	59

#### A-weighted sound pressure level $L_{p,ar}$ dB(A)

10 m<sup>2</sup> normally isolated room, distance from casing – 3 m.

Surroundings	48
--------------	----

### Temperature efficiency

Outside temperature, °C	Winter					Summer		
	-23	-15	-10	-5	0	25	30	35
After heat exchanger, °C	11,1	13,0	14,2	15,4	16,7	22,7	24,0	25,2

indoor +22°C, 20% RH

### Hot water air heater

Water temperature in/out, °C	Winter		
	80/60	70/50	60/40
Capacity, kW	24,5	24,5	24,5
Flow rate, dm <sup>3</sup> /h	1083	1077	1072
Pressure drop, kPa	8,6	8,8	8,9
Temperature in/out, °C	11,1/22,0		
Maximal capacity, kW	55,2	45,1	34,9
Connection, "	1		

### Performance

Supply air filter F7, exhaust air filter M5

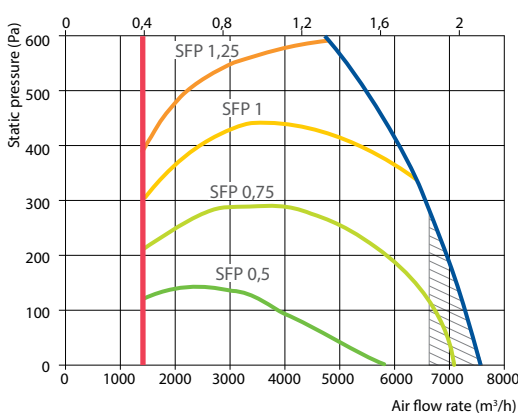

Does not conform to ErP2018 requirements

### Shown as right (R1)

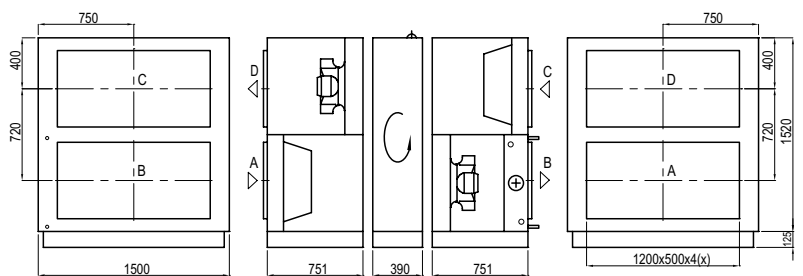

### Shown as left (L1)

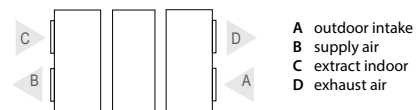

- A outdoor intake
- B supply air
- C extract indoor
- D exhaust air

### Accessories (p. 120)

Closing damper	SRU-M-1200x600+LF24/LM24
Silencer	A/D STS-IVR3BA-1200-600-700-S
	B/C STS-IVR3BA-1200-600-1250-S
PPU	PPU-HW-3R-20-4,0-W2
Air heater-cooler	DCW-7,0-47
2-way valve	HRB3 32 16+AMB162
DX cooler	DCF-7,0-48-3
Cooling unit	3xMOU-55HFN6-KA8243

# VERSO CF Standard

## Air handling units with counterflow plate heat exchangers

### Sizes and capacities of VERSO CF units

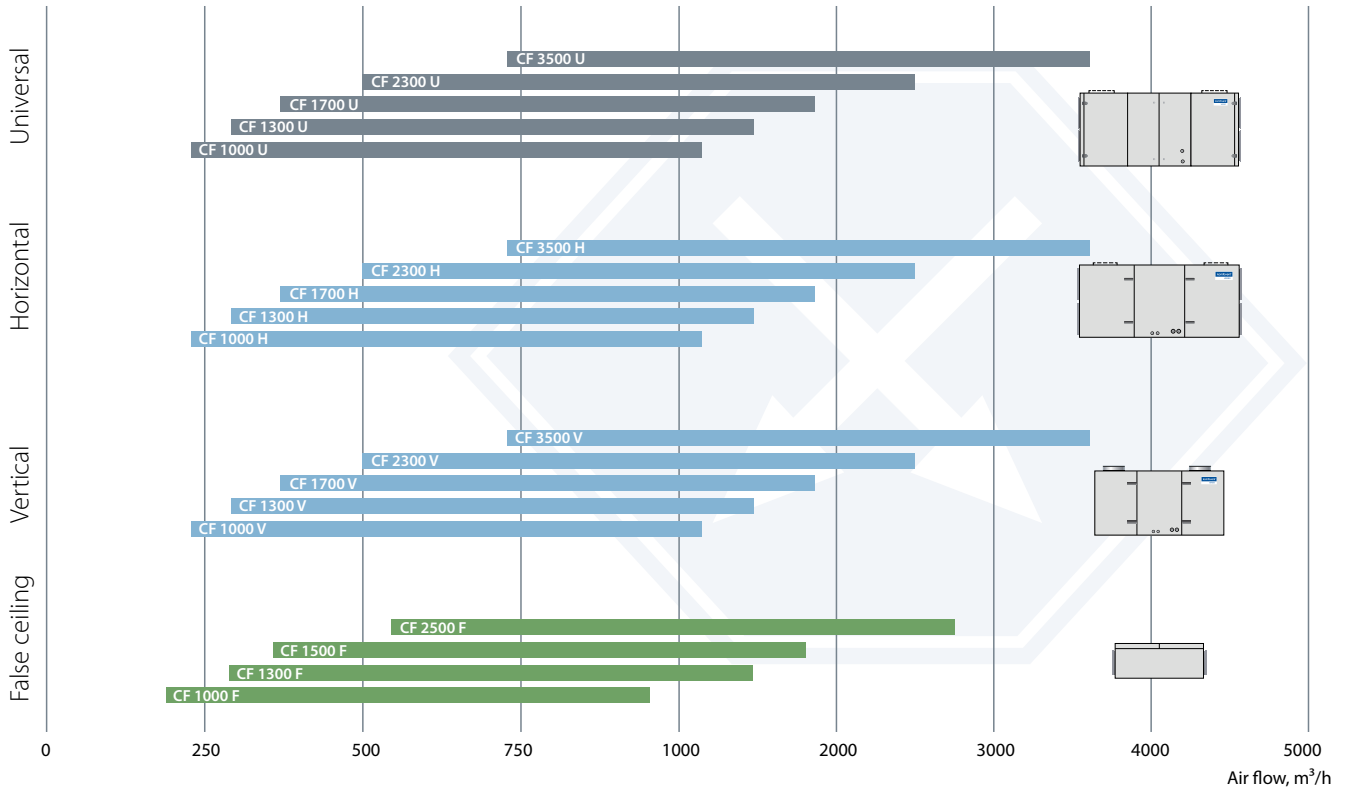

### Modifications of Verso CF units

Unit	Supply / exhaust air filter class		Heater			Cooler		Inspection side		Control system C5
	F7	M5	HE	HW	HCW	CW	DX	R1	L1	panel C5.1
Verso CF 1000 U	●	●	○		○	△	○	○	○	●
Verso CF 1000 H / V	●	●	○	○		△	△	○	○	●
Verso CF 1000 F	●	●	●	△	△	△	△	○	○	●
Verso CF 1300 U	●	●	○		○	△	○	○	○	●
Verso CF 1300 H / V	●	●	○	○		△	△	○	○	●
Verso CF 1300 F	●	●	●	△	△	△	△	○	○	●
Verso CF 1500 F	●	●	●	△	△	△	△	○	○	●
Verso CF 1700 U	●	●	○		○	△	○	○	○	●
Verso CF 1700 H / V	●	●	○	○		△	△	○	○	●
Verso CF 2300 U	●	●	○		○	△	○	○	○	●
Verso CF 2300 H / V	●	●	○	○		△	△	○	○	●
Verso CF 2500 F	●	●	●	△		△	△	○	○	●
Verso CF 3500 U	●	●	○	○	○	△	○	○	○	●
Verso CF 3500 H / V	●	●	○	○		△	△	○	○	●

● standard equipment    ○ possible choice    △ ordered separately duct heater/cooler

The markings are explained on p. 7.

# Verso CF 1000 U/H/V

Nominal air flow according to ErP 2018, m <sup>3</sup> /h	1050
Panel thickness, mm	50
Unit weight, kg	269
Supply voltage HE, V	3~400
Supply voltage HW, V	1~230
Maximal operating current HE, A	9,5
Maximal operating current HW, A	3,3
Filters dimensions BxHxL, mm	800x400x46
Electric power input of the fan drive at maximum flow rate, W	178
Electric air heater capacity, kW / Δt, °C	4,5/11,9
Control panel	C5.1
Maintenance space, mm	800



The photo is intended for informational purposes only. exact details may vary.

### Acoustic data

#### A-weighted sound power level L<sub>wa</sub>, dB(A) at nominal flow rate

Supply inlet	56
Supply outlet	74
Exhaust inlet	57
Exhaust outlet	74
Casing	54

#### A-weighted sound pressure level L<sub>pa</sub>, dB(A)

10 m<sup>2</sup> normally isolated room, distance from casing – 3 m.

Surroundings	43
--------------	----

### Performance (Verso CF 1000 UH data)

Supply air filter F7, exhaust air filter M5

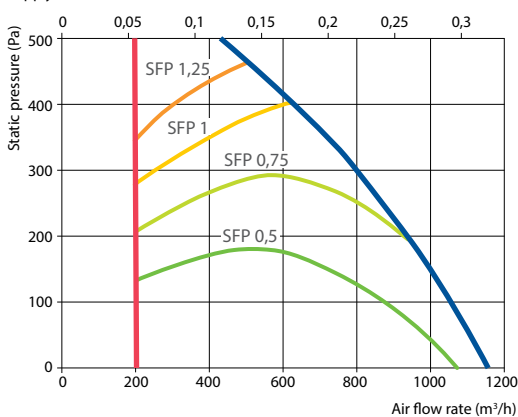

### Temperature efficiency

Outside temperature, °C	Winter					Summer		
	-23	-15	-10	-5	0	25	30	35
After heat exchanger, °C	15,2	16,0	16,8	17,1	18,0	22,6	23,5	24,7

indoor +22°C, 20% RH

### Changeover water/ DX heating – cooling exchanger (HCW/HCDX)

	Winter		Summer	
	Winter	Summer	Winter	Summer
Water temperature in/out, °C	60/40	7/12	–	–
Condensation/evaporation T, °C	–	–	45	45/5
Capacity, kW	2,4	6,8	2,4	7,3
Maximal capacity, kW	8,7	8,9	5,2	9,9
Pressure drop, kPa	1,8	34,5	–	–
Air temperature in/out, °C	15,2 / 22	30 / 18	15,2 / 22	30 / 18
Connection, " / mm	½		½ / 22	

Summer +30°C/ 50%

#### Shown as right (R1)

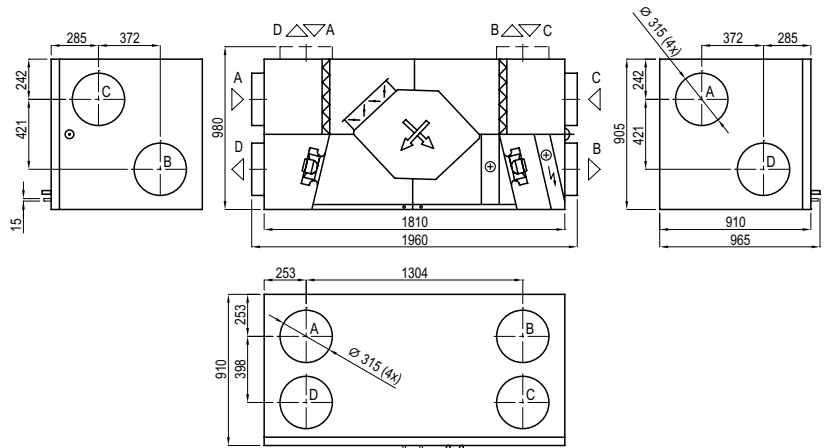

#### Shown as left (L1)

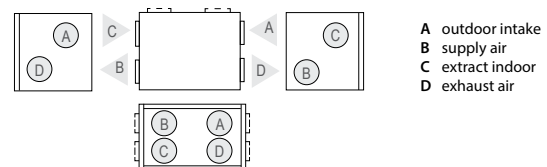

### Accessories (p. 120)

Closing damper	AGUJ-M-315+LF24/LM24
Silencer	A/D AGS-315-100-900-M
	B/C AGS-315-100-1200-M
PPU	PPU-HW-3R-15-0,63-W1
Water cooler	DCW-0,7-5
2-way valve	VVP47.15-2,5+SSP61
DX cooler	DCF-0,7-5
Cooling unit	MOU-18HFN6-KA8243

# Verso CF 1000 F

Nominal air flow according to ErP 2018, m <sup>3</sup> /h	850
Panel thickness, mm	50
Unit weight, kg	173
Supply voltage HE, V	3~400
Supply voltage HW, V	1~230
Maximal operating current HE, A	7,3
Maximal operating current HW, A	3,3
Filters dimensions BxHxL, mm	550x420x46
Electric power input of the fan drive at maximum flow rate, W	168
Electric air heater capacity, kW / Δt, °C	3/9,8
Control panel	C5.1
Maintenance space, mm	400



The photo is intended for informational purposes only. exact details may vary.

## Acoustic data

A-weighted sound power level  $L_{WA}$ , dB(A) at nominal flow rate

Supply inlet	59
Supply outlet	73
Exhaust inlet	59
Exhaust outlet	73
Casing	54

A-weighted sound pressure level  $L_{PA}$ , dB(A)

10 m<sup>2</sup> normally isolated room, distance from casing – 3 m.

Surroundings	42
--------------	----

## Temperature efficiency

Outside temperature, °C	Winter					Summer		
	-23	-15	-10	-5	0	25	30	35
After heat exchanger, °C	17,2	17,4	17,8	18,1	18,7	22,6	23,6	24,7

indoor +22°C, 20% RH

## Hot water duct air heater (DH)\*

Water temperature in/out, °C	Winter		
	80/60	70/50	60/40
Capacity, kW	1,4	1,4	1,4
Flow rate, dm <sup>3</sup> /h	60	60	60
Pressure drop, kPa	2,3	2,3	2,4
Temperature in/out, °C	17,2/22		
Maximal capacity, kW	8,8	7,0	5,2
Connection, "	½		

\* option

## Performance

Supply air filter F7, exhaust air filter M5

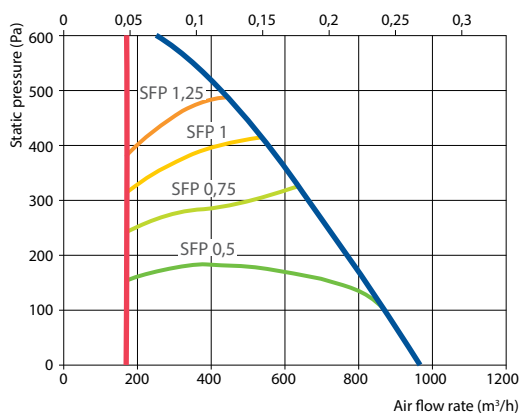

## Shown as right (R1)

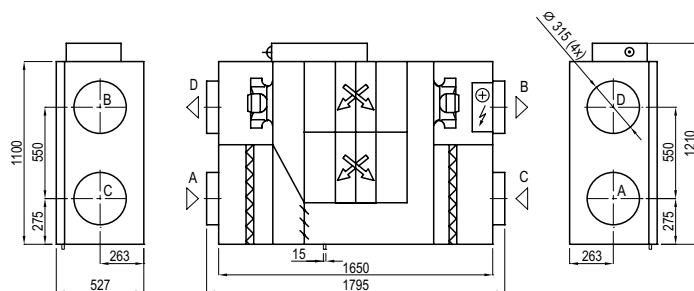

## Accessories (p. 120)

Closing damper	AGUJ-M-315+LF24/LM24
Silencer	A/D AGS-315-100-900-M
	B/C AGS-315-100-1200-M
Water heater	DH-315
PPU	PPU-HW-3R-15-1-W2
Air heater-cooler	DCW-0,9-6 / DHCW-315
2-way valve	VVP47.15-2,5+SSP61
DX cooler	DCF-0,9-6
Cooling unit	MOU-18HFN6-KA8243

## Shown as left (L1)

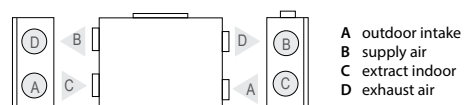



# Verso CF 1300 U/H/V

Nominal air flow according to ErP 2018, m <sup>3</sup> /h	1340
Panel thickness, mm	50
Unit weight, kg	225
Supply voltage HE, V	3~400
Supply voltage HW, V	1~230
Maximal operating current HE, A	11,7
Maximal operating current HW, A	5,5
Filters dimensions BxHxL, mm	800x400x46
Electric power input of the fan drive at maximum flow rate, W	370
Electric air heater capacity, kW / Δt, °C	4,5/8,9
Control panel	C5.1
Maintenance space, mm	800



The photo is intended for informational purposes only. exact details may vary.

### Acoustic data

#### A-weighted sound power level L<sub>WAr</sub>, dB(A) at nominal flow rate

Supply inlet	62
Supply outlet	81
Exhaust inlet	63
Exhaust outlet	81
Casing	59

#### A-weighted sound pressure level L<sub>pAr</sub>, dB(A)

10 m<sup>2</sup> normally isolated room, distance from casing – 3 m.

Surroundings	48
--------------	----

### Performance

(Verso CF 1300 UH data)

Supply air filter F7, exhaust air filter M5

Air flow rate (m<sup>3</sup>/s)

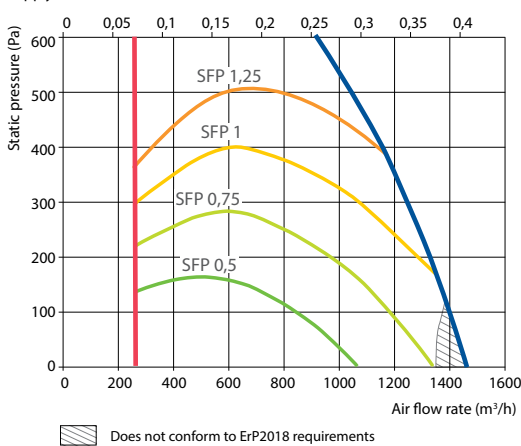

### Temperature efficiency

Outside temperature, °C	Winter					Summer		
	-23	-15	-10	-5	0	25	30	35
After heat exchanger, °C	14,6	15,5	16,4	16,8	17,8	22,6	23,6	24,6

indoor +22°C, 20% RH

### Changeover water/ DX heating – cooling exchanger (HCW/HCDX)

	Winter		Summer	
	Winter	Summer	Winter	Summer
Water temperature in/out, °C	60/40	7/12	–	–
Condensation/evaporation T, °C	–	–	45	45/5
Capacity, kW	3,3	8,6	3,3	9,3
Maximal capacity, kW	10,7	10,5	6,2	11,5
Pressure drop, kPa	2,1	53,7	–	–
Air temperature in/out, °C	14,6 / 22	30 / 18	14,6 / 22	30 / 18
Connection, " / mm	½		½ / 22	

Summer: +30°C / 50%

### Shown as right (R1)

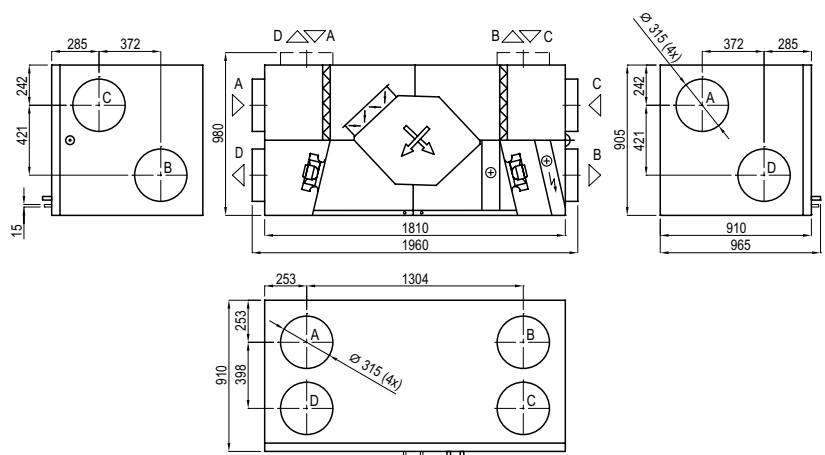

### Shown as left (L1)

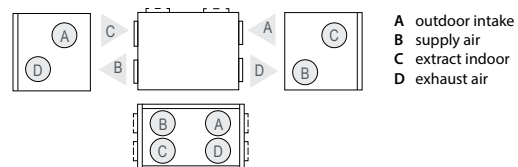

### Accessories (p. 120)

Closing damper	AGUJ-M-315+LF24/LM24
Silencer	A/D AGS-315-100-900-M
	B/C AGS-315-100-1200-M
PPU	PPU-HW-3R-15-1-W2
Water cooler	DCW-1,4-9
2-way valve	VVP47.20-4,0+SSP61
DX cooler	DCF-1,4-10
Cooling unit	MOU-36HFN6-KA8243

# Verso CF 1300 F

Nominal air flow according to ErP 2018, m <sup>3</sup> /h	1340
Panel thickness, mm	50
Unit weight, kg	175
Supply voltage HE, V	3~400
Supply voltage HW, V	1~230
Maximal operating current HE, A	11,7
Maximal operating current HW, A	5,5
Filters dimensions BxHxL, mm	550x420x46
Electric power input of the fan drive at maximum flow rate, W	360
Electric air heater capacity, kW / Δt, °C	4,5/9,1
Control panel	C5.1
Maintenance space, mm	400



The photo is intended for informational purposes only. exact details may vary.

## Acoustic data

A-weighted sound power level  $L_{WA}$ , dB(A) at nominal flow rate

Supply inlet	65
Supply outlet	80
Exhaust inlet	65
Exhaust outlet	80
Casing	59

A-weighted sound pressure level  $L_{PA}$ , dB(A)

10 m<sup>2</sup> normally isolated room, distance from casing – 3 m.

Surroundings	48
--------------	----

## Performance

Supply air filter F7, exhaust air filter M5

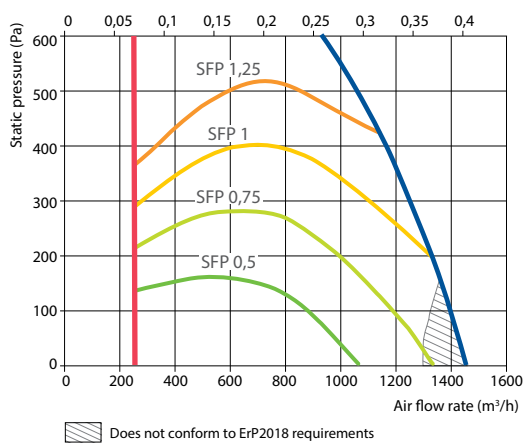

## Temperature efficiency

Outside temperature, °C	Winter					Summer		
	-23	-15	-10	-5	0	25	30	35
After heat exchanger, °C	16,2	16,5	16,8	17,4	18,1	22,6	23,7	24,9

indoor +22°C, 20% RH

## Hot water duct air heater (DH)\*

Water temperature in/out, °C	Winter		
	80/60	70/50	60/40
Capacity, kW	2,6	2,6	2,6
Flow rate, dm <sup>3</sup> /h	115	115	114
Pressure drop, kPa	4,4	4,4	4,4
Temperature in/out, °C	16,2 / 22,0		
Maximal capacity, kW	11,9	9,5	7,1
Connection, "	½		

\* option

Shown as right (R1)

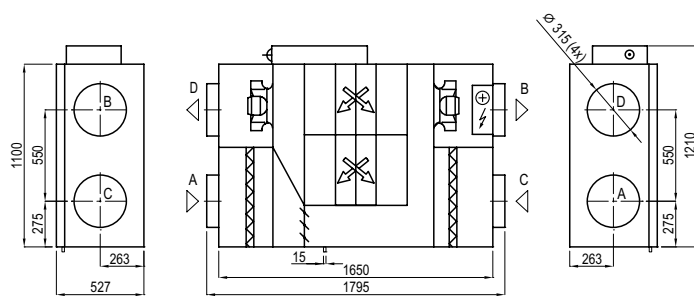

## Accessories (p. 120)

Closing damper	AGUJ-M-315+LF24/LM24
Silencer	A/D AGS-315-100-900-M
	B/C AGS-315-100-1200-M
Water heater	DH-315
PPU	PPU-HW-3R-15-1-W2
Air heater-cooler	DCW-1,4-9 / DHCW-315
2-way valve	VVP47.20-4,0+SSP61
DX cooler	DCF-1,4-10
Cooling unit	MOU-36HFN6-KA8243

Shown as left (L1)

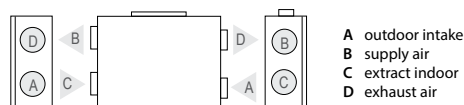

# Verso CF 1500 F

Nominal air flow according to ErP 2018, m <sup>3</sup> /h	1475
Panel thickness, mm	50
Unit weight, kg	190
Supply voltage HE, V	3~400
Supply voltage HW, V	1~230
Maximal operating current HE, A	12,9
Maximal operating current HW, A	6,7
Filters dimensions BxHxL, mm	550x420x46
Electric power input of the fan drive at maximum flow rate, W	460
Electric air heater capacity, kW / Δt, °C	4,5 / 7,5
Control panel	C5.1
Maintenance space, mm	400



The photo is intended for informational purposes only. exact details may vary.

### Acoustic data

**A-weighted sound power level  $L_{w,ar}$  dB(A) at nominal flow rate**

Supply inlet	60
Supply outlet	75
Exhaust inlet	60
Exhaust outlet	74
Casing	57

**A-weighted sound pressure level  $L_{p,ar}$  dB(A)**

10 m<sup>2</sup> normally isolated room, distance from casing – 3 m.

Surroundings	46
--------------	----

### Performance

Supply air filter F7, exhaust air filter M5

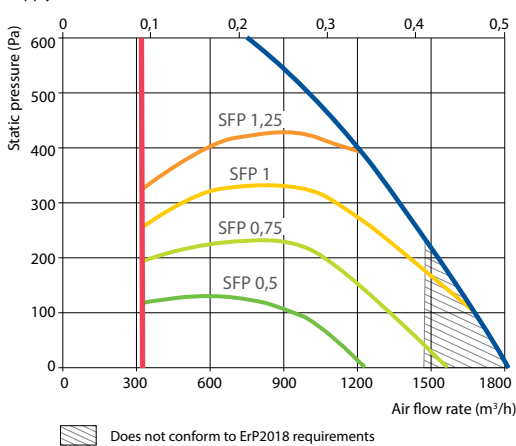

### Temperature efficiency

Outside temperature, °C	Winter					Summer		
	-23	-15	-10	-5	0	25	30	35
After heat exchanger, °C	16,0	16,3	16,6	17,3	18,0	22,6	23,8	25,0

indoor +22°C, 20% RH

### Hot water duct air heater (DH)\*

Water temperature in/out, °C	Winter		
	80/60	70/50	60/40
Capacity, kW	3,0	3,0	3,0
Flow rate, dm <sup>3</sup> /h	131	131	131
Pressure drop, kPa	5,2	5,2	5,3
Temperature in/out, °C	16,0 / 22,0		
Maximal capacity, kW	12,6	10,1	7,6
Connection, "	½		

\* option

Shown as right (R1)

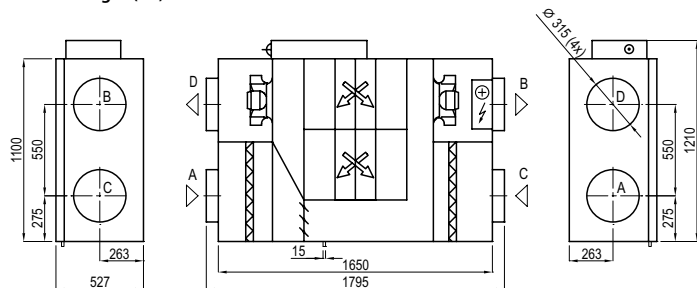

Shown as left (L1)

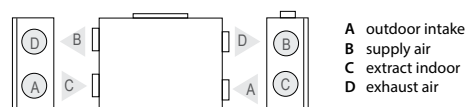

### Accessories (p. 120)

Closing damper	AGUJ-M-315+LF24/LM24
Silencer	A/D AGS-315-100-900-M
	B/C AGS-315-100-1200-M
Water heater	DH-315
PPU	PPU-HW-3R-15-1-W2
Air heater-cooler	DCW-1,6-11/DHCW-315
2-way valve	VVP47.20-4,0+SSP61
DX cooler	DCF-1,6-11
Cooling unit	MOU-36HFN6-KA8243

# Verso CF 1700 U/H/V

Nominal air flow according to ErP 2018, m <sup>3</sup> /h	1515
Panel thickness, mm	50
Unit weight, kg	243
Supply voltage HE, V	3~400
Supply voltage HW, V	1~230
Maximal operating current HE, A	12,9
Maximal operating current HW, A	6,7
Filters dimensions BxHxL, mm	800x400x46
Electric power input of the fan drive at maximum flow rate, W	465
Electric air heater capacity, kW / Δt, °C	4,5/7,4
Control panel	C5.1
Maintenance space, mm	800



The photo is intended for informational purposes only. exact details may vary.

## Acoustic data

A-weighted sound power level  $L_{WA}$ , dB(A) at nominal flow rate

Supply inlet	58
Supply outlet	75
Exhaust inlet	58
Exhaust outlet	75
Casing	57

A-weighted sound pressure level  $L_{PA}$ , dB(A)

10 m<sup>2</sup> normally isolated room, distance from casing – 3 m.

Surroundings	46
--------------	----

## Performance (Verso CF 1700 UH data)

Supply air filter F7, exhaust air filter M5

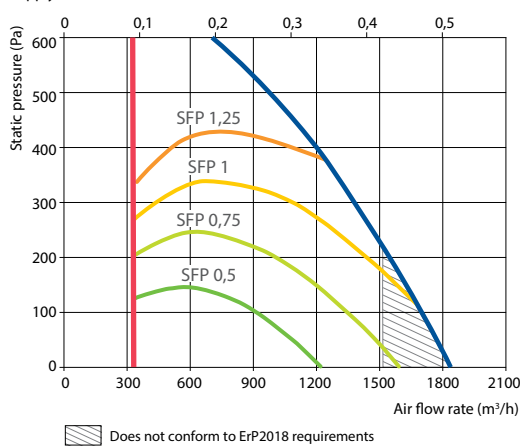

## Temperature efficiency

Outside temperature, °C	Winter					Summer		
	-23	-15	-10	-5	0	25	30	35
After heat exchanger, °C	14,4	15,3	16,2	16,6	17,6	22,6	23,6	24,7

indoor +22°C, 20% RH

## Changeover water/ DX heating – cooling exchanger (HCW/HCDX)

	Winter		Summer	
	Water temperature in/out, °C	Condensation/evaporation T, °C	Capacity, kW	Maximal capacity, kW
Water temperature in/out, °C	60/40	7/12	–	–
Condensation/evaporation T, °C	–	–	45	45/5
Capacity, kW	3,9	9,8	3,7	10,0
Maximal capacity, kW	11,7	11,3	6,5	12,1
Pressure drop, kPa	2,3	67,3	–	–
Air temperature in/out, °C	14,4 / 22	30 / 18	14,4 / 22	30 / 18
Connection, " / mm	1/2		5/8 / 22	

Summer: +30°C / 50%; DX – 1450 m<sup>3</sup>/h

## Shown as right (R1)

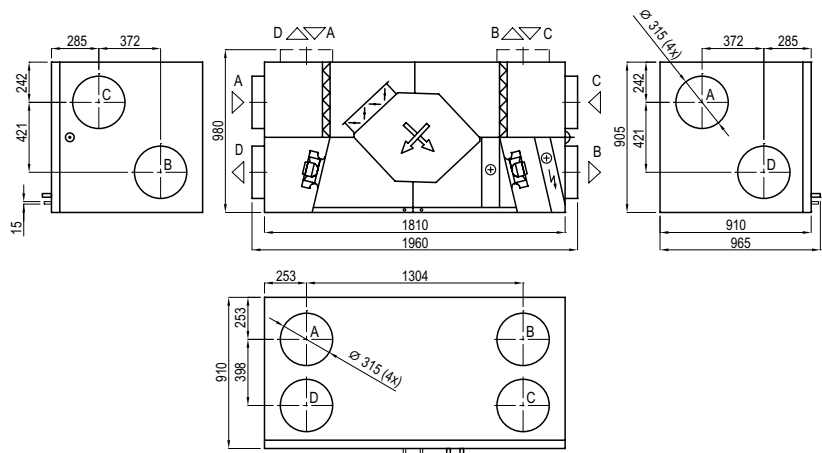

## Shown as left (L1)

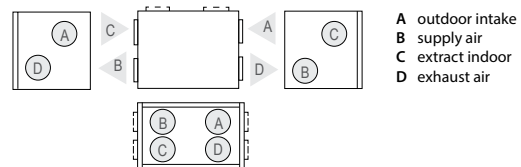

A outdoor intake  
B supply air  
C extract indoor  
D exhaust air

## Accessories (p. 120)

Closing damper	AGUJ-M-315-LF24/LM24
Silencer	A/D AGS-315-100-900-M B/C AGS-315-100-1200-M
PPU	PPU-HW-3R-15-1,6-W2
Water cooler	DCW-1,6-11
2-way valve	VVP47.20-4,0+SSP61
DX cooler	DCF-1,6-11
Cooling unit	MOU-36HFN6-KA8243

# Verso CF 2300 U/H/V

Nominal air flow according to ErP 2018, m <sup>3</sup> /h	1990
Panel thickness, mm	50
Unit weight, kg	250
Supply voltage HE, V	3~400
Supply voltage HW, V	1~230
Maximal operating current HE, A	16,8
Maximal operating current HW, A	6,3
Filters dimensions BxHxL, mm	800x400x46
Electric power input of the fan drive at maximum flow rate, W	660
Electric air heater capacity, kW / Δt, °C	7,5/8,9
Control panel	C5.1
Maintenance space, mm	800



The photo is intended for informational purposes only. exact details may vary.

### Acoustic data

#### A-weighted sound power level L<sub>wa</sub>, dB(A) at nominal flow rate

Supply inlet	60
Supply outlet	78
Exhaust inlet	60
Exhaust outlet	78
Casing	57

#### A-weighted sound pressure level L<sub>pa</sub>, dB(A)

10 m<sup>2</sup> normally isolated room, distance from casing – 3 m.

Surroundings	47
--------------	----

### Performance (Verso CF 2300 UH data)

Supply air filter F7, exhaust air filter M5

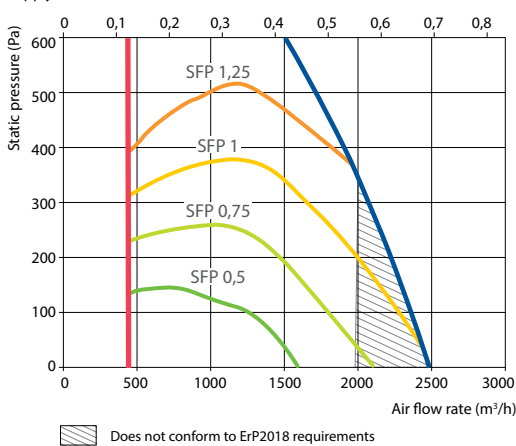

### Temperature efficiency

Outside temperature, °C	Winter					Summer		
	-23	-15	-10	-5	0	25	30	35
After heat exchanger, °C	15,7	16,2	16,5	17,2	18,0	22,5	23,4	24,4

indoor +22°C, 20% RH

### Changeover water/ DX heating – cooling exchanger (HCW/HCDX)

	Winter		Summer	
	Water temperature in/out, °C	Condensation/evaporation T, °C	Capacity, kW	Maximal capacity, kW
Water temperature in/out, °C	60/40	7/12	–	–
Condensation/evaporation T, °C	–	–	45	45/5
Capacity, kW	4,2	12,5	3,6	11,7
Maximal capacity, kW	13,0	12,6	6,7	13,2
Pressure drop, kPa	2	54,7	–	–
Air temperature in/out, °C	15,7 / 22	30 / 18,4	15,7 / 22	30 / 18
Connection, " / mm	¾		½ / 22	

Summer: +30°C/ 50%; HCW – 2200 m<sup>3</sup>/h; DX – 1450 m<sup>3</sup>/h

### Shown as right (R1)

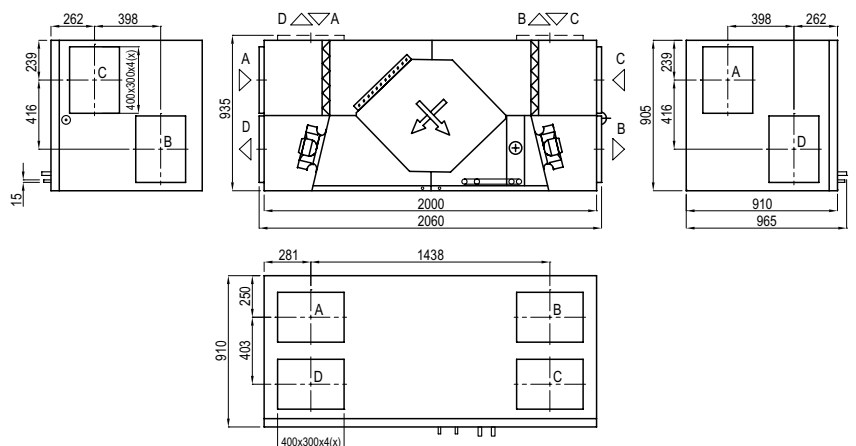

### Shown as left (L1)

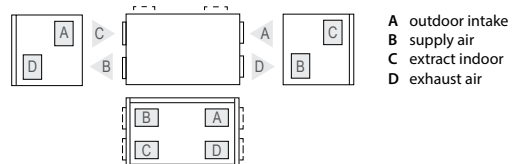

### Accessories (p. 120)

Closing damper	H	SRU-M-300x400+LF24/LM24
	V	SRU-M-400x300+LF24/LM24
Silencer	A/D	STS-IVR3BA-600-400-700-S
	B/C	STS-IVR3BA-600-400-1250-S
PPU		PPU-HW-3R-15-1,6-W2
Air heater-cooler		DCW-2,5-17
2-way valve		VVP45.25-6,3+SSB61
DX cooler		DCF-2,5-17
Cooling unit		MOU-55HFN6-KA8243

# Verso CF 2500 F

Nominal air flow according to ErP 2018, m <sup>3</sup> /h	2590
Panel thickness, mm	50
Unit weight, kg	340
Supply voltage HE, V	3~400
Supply voltage HW, V	1~230
Maximal operating current HE, A	16,9
Maximal operating current HW, A	6,3
Filters dimensions BxHxL, mm	888x420x96
Electric power input of the fan drive at maximum flow rate, W	640
Electric air heater capacity, kW / Δt, °C	7,5/7,8
Control panel	C5.1
Maintenance space, mm	620

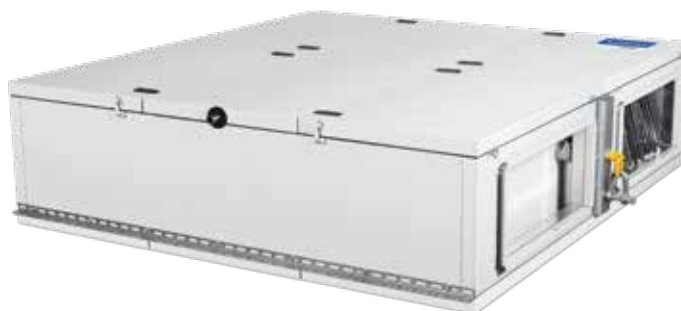

The photo is intended for informational purposes only. exact details may vary.

## Acoustic data

A-weighted sound power level L<sub>WA</sub>, dB(A) at nominal flow rate

Supply inlet	64
Supply outlet	83
Exhaust inlet	64
Exhaust outlet	83
Casing	62

A-weighted sound pressure level L<sub>pA</sub>, dB(A)

10 m<sup>2</sup> normally isolated room, distance from casing – 3 m.

Surroundings	51
--------------	----

## Performance

Supply air filter F7, exhaust air filter M5

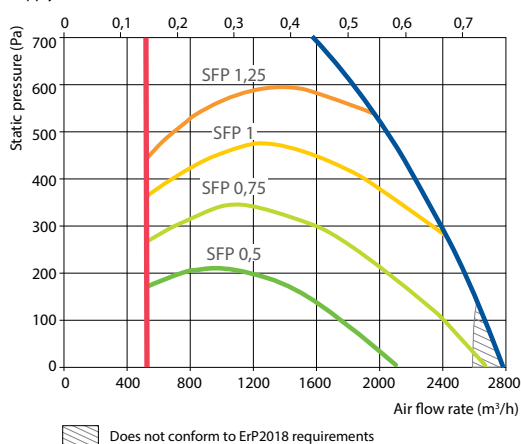

## Temperature efficiency

Outside temperature, °C	Winter					Summer		
	-23	-15	-10	-5	0	25	30	35
After heat exchanger, °C	13,9	14,9	15,9	16,6	17,6	22,6	23,6	24,7

indoor +22°C, 20% RH

## Hot water air heater (SVK)\*

Water temperature in/out, °C	Winter		
	80/60	70/50	60/40
Capacity, kW	7,0	7,0	7,0
Flow rate, dm <sup>3</sup> /h	311	309	308
Pressure drop, kPa	4,8	4,8	4,9
Temperature in/out, °C	13,9 / 22		
Maximal capacity, kW	22,3	18,0	13,6
Connection, "	½		

\* option

## Shown as right (R1)

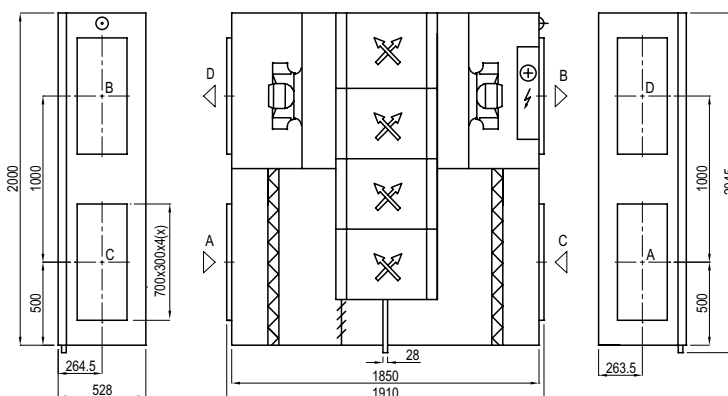

## Shown as left (L1)

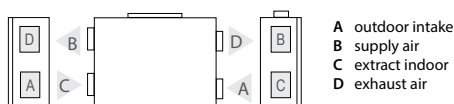

## Accessories (p. 120)

Closing damper	SRU-M-700x300+LF24/LM24
Silencer	A/D STS-IVR3BA-800-300-700-S
	B/C STS-IVR3BA-800-300-1250-S
Water heater	SVK-700x400-2R
PPU	PPU-HW-3R-15-1-W2
Air heater-cooler	DCW-2,5-17
2-way valve	VVP45.25-6,3+SSB61
DX cooler	DCF-2,5-17
Cooling unit	MOU-55HFN6-KA8243

# Verso CF 3500 U/H/V

Nominal air flow according to ErP 2018, m <sup>3</sup> /h	3540
Panel thickness, mm	50
Unit weight, kg	500
Supply voltage HE, V	3~400
Supply voltage HW, V	3~400
Maximal operating current HE, A	19,8
Maximal operating current HW, A	7,1
Filters dimensions BxHxL, mm	525x510x46
Electric power input of the fan drive at maximum flow rate, W	960
Electric air heater capacity, kW / Δt, °C	9/6,8
Control panel	C5.1
Maintenance space, mm	1000



The photo is intended for informational purposes only. exact details may vary.

### Acoustic data

#### A-weighted sound power level L<sub>wa</sub>, dB(A) at nominal flow rate

Supply inlet	55
Supply outlet	78
Exhaust inlet	56
Exhaust outlet	77
Casing	54

#### A-weighted sound pressure level L<sub>pa</sub>, dB(A)

10 m<sup>2</sup> normally isolated room, distance from casing – 3 m.

Surroundings	43
--------------	----

### Performance (Verso CF 3500 UH data)

Supply air filter F7, exhaust air filter M5

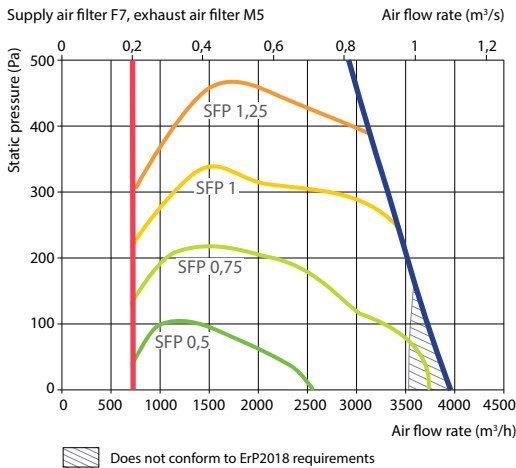

### Temperature efficiency

	Winter					Summer		
Outside temperature, °C	-23	-15	-10	-5	0	25	30	35
After heat exchanger, °C	14,0	15,0	15,9	16,3	17,4	22,6	23,7	24,8

indoor +22°C, 20% RH

### Changeover water/ DX heating – cooling exchanger (HCW/HCDX)

	Winter	Summer	Winter	Summer
Water temperature in/out, °C	60/40	7/12	-	-
Condensation/evaporation T, °C	-	-	45	45/5
Capacity, kW	9,5	17,7	8,2	21,8
Maximal capacity, kW	18,7	17,7	18,3	30,9
Pressure drop, kPa	3,6	96,4	-	-
Air temperature in/out, °C	14,0 / 22	30 / 20,6	14,0 / 22	30 / 18
Connection, " / mm	¾		2x½/2x22	

Summer: 30°C / 50%; DX - 3150 m<sup>3</sup>/h

#### Shown as right (R1)

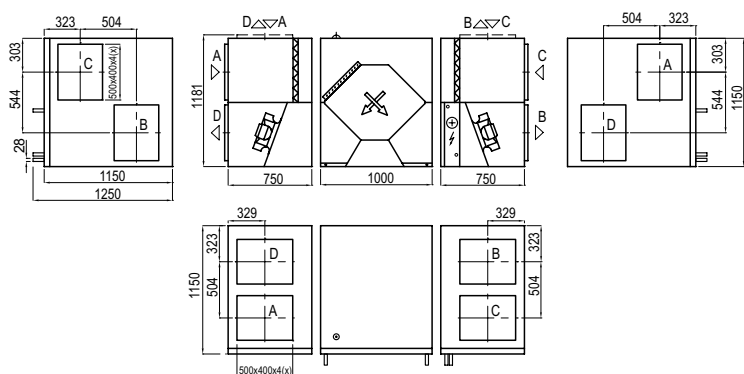

#### Shown as left (L1)

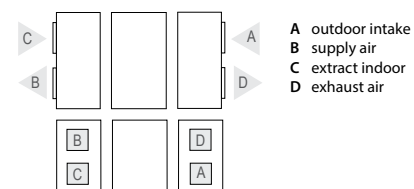

- A outdoor intake
- B supply air
- C extract indoor
- D exhaust air

### Accessories (p. 120)

Closing damper	H	SRU-M-400x500+LF24/LM24
	V	SRU-M-500x400+LF24/LM24
Silencer	A/D	STS-IVR3BA-800-500-700-S
	B/C	STS-IVR3BA-800-500-1250-S
PPU		PPU-HW-3R-15-2,5-W2
Air heater-cooler		DCW-4,0-27
2-way valve		VVP45.25-6,3+SSB61
DX cooler		DCF-4,0-27-2
Cooling unit		2xMOU-48HFN6-KA8243



# VERSO S Standard

## False ceiling supply air handling units

### Sizes and capacities of VERSO S Standard units

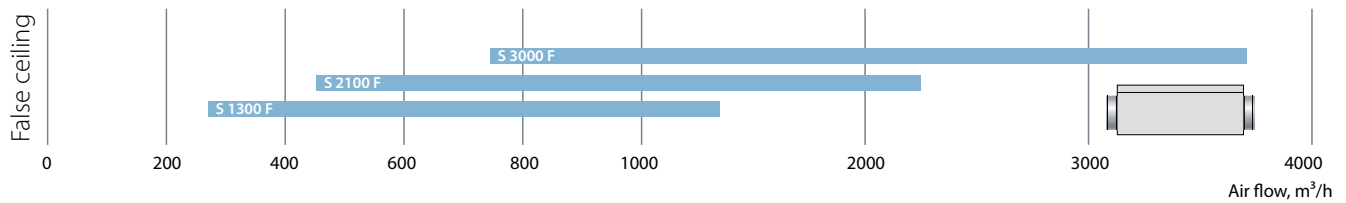

### Modifications of VERSO S Standard units

Unit	Supply air filter class	Heater		Cooler		Inspection side		Control system C5 panel C5.1
		HE	HW	CW	DX	R1	L1	
Verso S 1300 F	●	○	○	△	△	○	○	●
Verso S 2100 F	●	○	○	△	△	○	○	●
Verso S 3000 F	●		●	△	△	○	○	●

● standard equipment      ○ possible choice      △ ordered separately duct heater/cooler

The markings are explained on p. 7.

# Verso S 1300 F

Nominal air flow, m <sup>3</sup> /h	1300
Panel thickness, mm	50
Unit weight, kg	46
Filters dimensions BxHxL, mm	558x287x46
Electric power input of the fan drive at reference flow rate, W	350
Control panel	C5.1
Maintenance space, mm	400



The photo is intended for informational purposes only. exact details may vary.

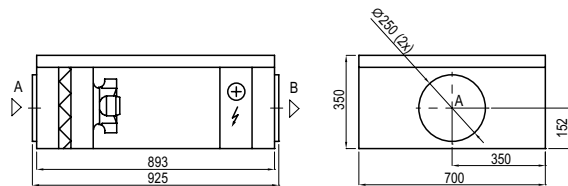

### Acoustic data

**A-weighted sound power level  $L_{WA}$ , dB(A) at nominal flow rate**

Supply inlet	74
Supply outlet	80
Casing	56

**A-weighted sound pressure level  $L_{PA}$ , dB(A)**

10 m<sup>2</sup> normally isolated room, distance from casing – 3 m.

Surroundings	46
--------------	----

### Technical data

Supply air handling unit	Supply voltage, V	Air heater capacity, kW	Maximal operating current, A	$\Delta T$ , °C
Verso S 1300 F-HE/9	3~400	9,0	15,7	19,2
Verso S 1300 F-HE/15	3~400	15,0	24,4	32,1
Verso S 1300 F-HW	1~230	–	3	–

### Performance

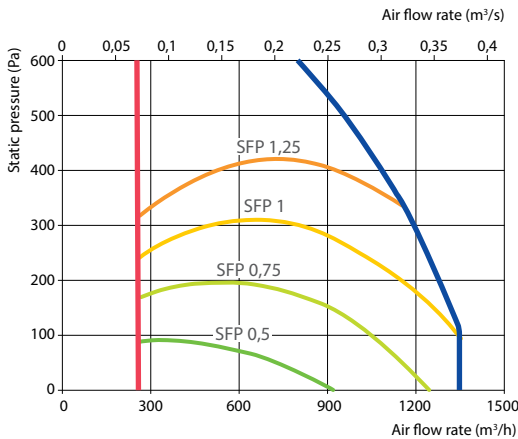

\* Compliance to ErP2018 requirements check with the selection program.

### Hot water air heater

Water temperature in/out, °C	80/60	70/50	60/40
Capacity, kW	10,1	8,4	6,5
Flow rate, dm <sup>3</sup> /h	448	369	286
Pressure drop, kPa	3,3	2,8	2,3
Temperature in/out, °C	-5 / 18,2	-5 / 14,2	-5,0 / 10,0
Maximal capacity, kW	10,1	8,4	6,5
Connection, "		½	

### Accessories (p. 120)

Closing damper	AGUJ-M-250+LF24/LM24
Silencer	A AGS-250-50-600-M
	B AGS-250-50-900-M
PPU	PPU-HW-3R-15-2.5-W2
Air heater-cooler	DCW-1,4-9
2-way valve	VVP47.20-4,0+SSP61
DX cooler	DCF-1,4-10
Cooling unit	MOU-36HFN6-KA8243

# Verso S 2100 F

Nominal air flow, m <sup>3</sup> /h	1900
Panel thickness, mm	50
Unit weight, kg	73
Filters dimensions B×H×L, mm	858×287×46
Electric power input of the fan drive at reference flow rate, W	340
Control panel	C5.1
Maintenance space, mm	400



The photo is intended for informational purposes only. exact details may vary.

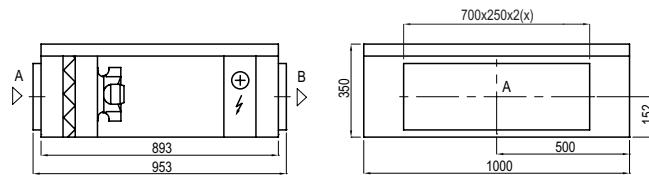

### Acoustic data

A-weighted sound power level  $L_{WA}$ , dB(A) at nominal flow rate

Supply inlet	70
Supply outlet	75
Casing	52

A-weighted sound pressure level  $L_{pA}$ , dB(A) 10 m<sup>2</sup> normally isolated room, distance from casing – 3 m.

Surroundings	41
--------------	----

### Technical data

Supply air handling unit	Supply voltage, V	Air heater capacity, kW	Maximal operating current, A	$\Delta T$ , °C
Verso S 2100 F-HE/15	3~400	15,0	24,7	21,9
Verso S 2100 F-HE/22,5	3~400	22,5	35,6	32,9
Verso S 2100 F-HW	1~230	–	3,3	–

### Performance

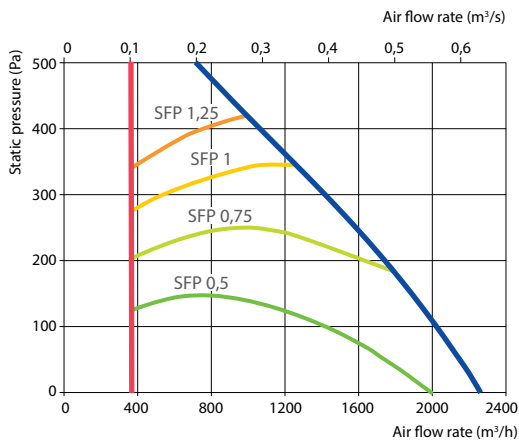

\* Compliance to ErP2018 requirements check with the selection program.

### Hot water air heater

Water temperature in/out, °C	80/60	70/50	60/40
Capacity, kW	17,0	14,4	11,7
Flow rate, dm <sup>3</sup> /h	752	632	511
Pressure drop, kPa	7,5	5,9	4,5
Temperature in/out, °C	-5,0/21,7	-5,0/17,5	-5,0/13,3
Maximal capacity, kW	17,0	14,4	11,7
Connection, "		½	

### Accessories (p. 120)

Closing damper	SRU-M-700x250+LF24/LM24
Silencer	A STS-IVR3BA-800-250-700-S
	B STS-IVR3BA-800-250-1250-S
PPU	PPU-HW-3R-15-2.5-W2
Air heater-cooler	DCW-2,0-13
2-way valve	VVP47.20-4,0+SSP61
DX cooler	DCF-2,0-14
Cooling unit	MOU-48HFN6-KA8243

# Verso S 3000 F

Nominal air flow, m <sup>3</sup> /h	3600
Panel thickness, mm	50
Unit weight, kg	130
Filters dimensions BxHxL, mm	450x480x96
Electric power input of the fan drive at reference flow rate, W	930
Control panel	C5.1
Maintenance space, mm	600



The photo is intended for informational purposes only. exact details may vary.

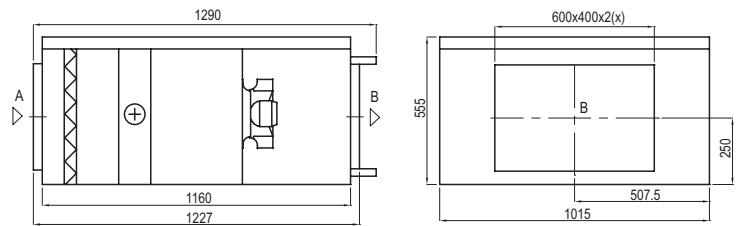

### Acoustic data

**A-weighted sound power level  $L_{wa}$ , dB(A) at nominal flow rate**

Supply inlet	67
Supply outlet	78
Casing	53

**A-weighted sound pressure level  $L_{pa}$ , dB(A)**

10 m<sup>2</sup> normally isolated room, distance from casing – 3 m.

Surroundings	42
--------------	----

### Technical data

Supply air handling unit	Supply voltage, V	Air heater capacity, kW	Maximal operating current, A	$\Delta T$ , °C
Verso S 3000 F-HW	3~400	–	3,8	–

### Performance

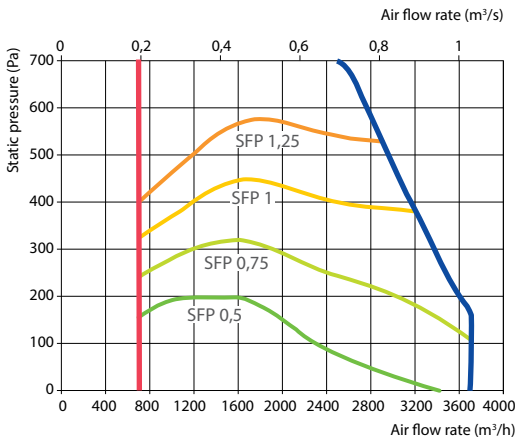

\* Compliance to ErP2018 requirements check with the selection program.

### Hot water air heater

Water temperature in/out, °C	80/60	70/50	60/40
Capacity, kW	32,6	32,6	32,6
Flow rate, dm <sup>3</sup> /h	1442	1435	1429
Pressure drop, kPa	4,5	4,5	4,5
Temperature in/out, °C	-5/22	-5/22	-5/22
Maximal capacity, kW	50,2	42,5	34,7
Connection, "	1		

### Accessories (p. 120)

Closing damper	SRU-M-600x400+LF24/LM24
Silencer	A STS-IVR3BA-600-400-700-S
	B STS-IVR3BA-600-400-1250-S
PPU	PPU-HW-3R-25-6.3-W2
Air heater-cooler	DCW-3,0-20
2-way valve	VVP45.25-6,3+SSB61
DX cooler	DCF-3,0-20-2
Cooling unit	2xMOU-36HFN6-KA8243

# VERSO Pro



## Convenient and safe

Unit design assures effective transportation and easy installation. Separate parts are compact, without projecting parts; therefore, it is easy to transport them to a designated area of the building, where they are later assembled. Finished air handling units are delivered to the customer in packages that are ready to be transported.

## Durable

Unit doors are mounted with firm and aesthetic-looking hinges and are locked with convenient and elegant locks. Door seals are made of firm and elastic foam-type gaskets, which are automatically fastened to the door by the newest machinery and are long-lasting and hermetic.

## User friendly

Filters, fans, heat exchangers, coolers and other components are easily accessible during use; if necessary, they can easily be replaced. A new filter clamping mechanism, not only assures tightness, but also essentially simplifies filter change procedure.

## Effective and universal

Unit walls are made of galvanized steel sheets with 50 mm thickness insulation. This assures not only effective heat and noise insulation, but also a high level of fire resistance. Air handling unit accessories – external grilles for supply/exhaust vents, hood and roof – allow installing units outside.

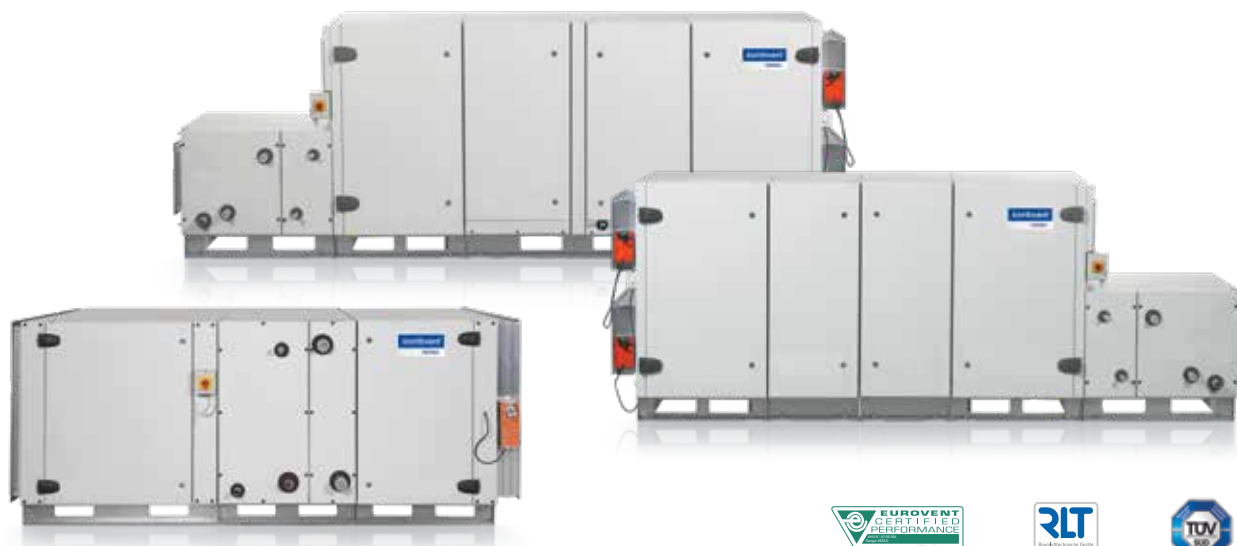

### Sizes and capacities of VERS0 Pro units

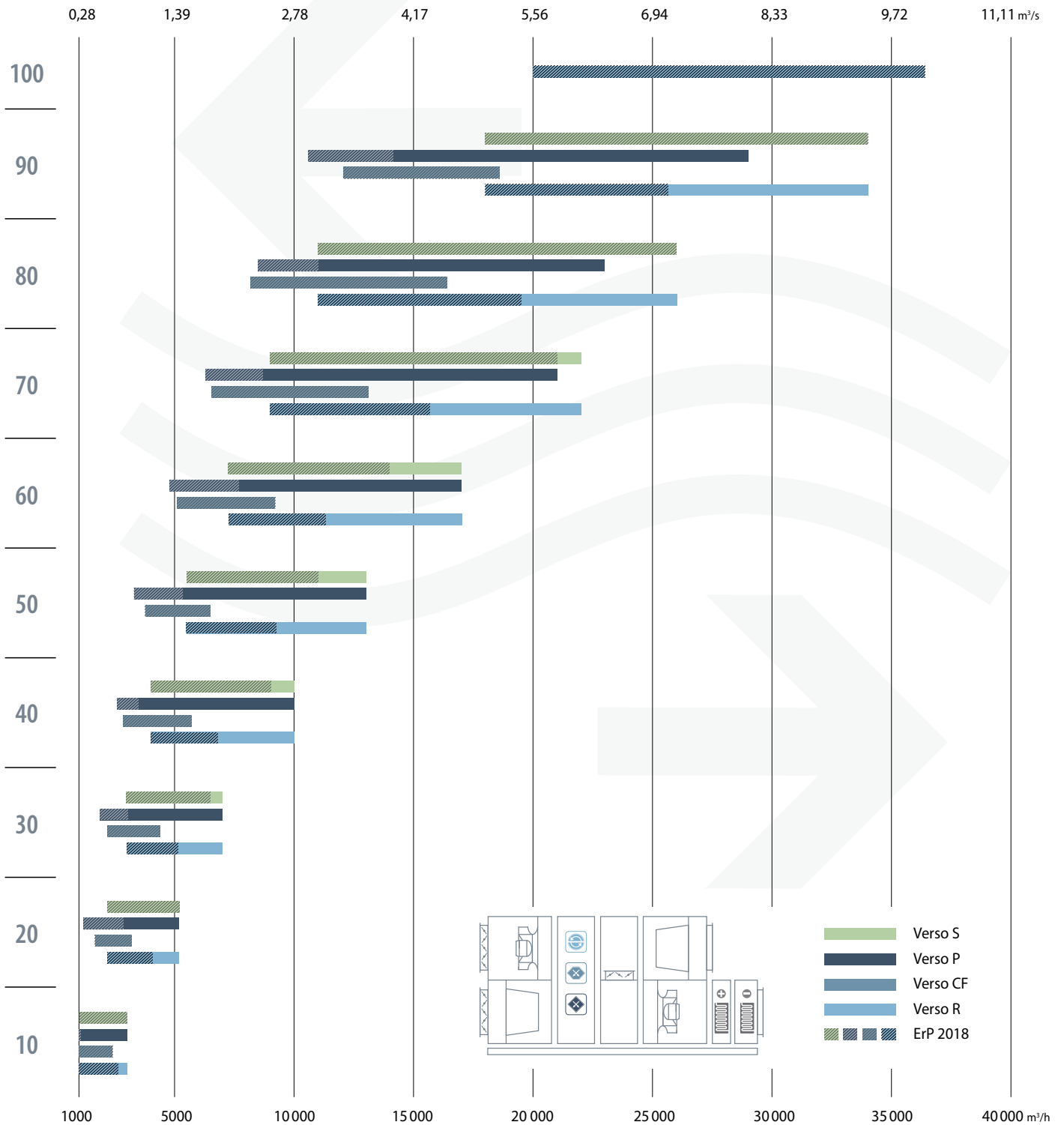

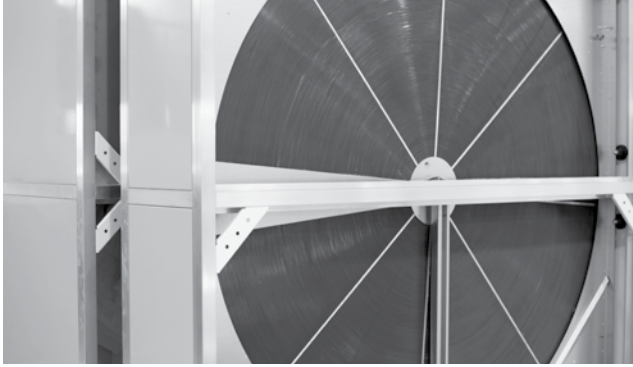

## Heat exchangers

### Rotary heat exchanger

Used in Verso R series units. Temperature efficiency factor – up to 86%. Possible wave height: 1.4 mm; 1.5 mm, 1.7 mm. Types of rotary heat exchangers:

- Condensation (aluminium);
- Sorption (aluminium with zeolith coating);
- Deep epoxy coating technology.

Aluminium foil is made of an aluminium alloy resistant to sea water. Rotary heat exchanger rotation speed is controlled by a frequency converter, according to the air temperature. The heat exchanger can be ordered with an installed purge section.

### Counter flow plate heat exchanger

Used in Verso CF series units. Temperature efficiency factor – up to 95% in wet conditions and up to 88% in dry conditions.

The plate heat exchanger is equipped with an automatic by-pass. Aluminium plates are made of an aluminium alloy resistant to sea water.

### Anti-frost precautions

Under conditions when the outdoor air temperature is low and humidity is high, the risk of heat exchanger frosting may occur. To avoid frosting of the heat exchanger the by-pass damper is opened. For an extremely low outdoor air temperature the duct-mounted electric preheater is recommended. The counter cross-flow heat exchanger is even more sensitive for low outside air temperatures, as the risk of icing appears in the temperature range from -3°C to -5°C and below. A standard aluminium cross-flow plate heat exchanger has better features, as the risk of icing appears only at -10°C. The lowest risk and the highest resistance to cold outside air is a competitive feature of the rotary heat exchanger, as it does not freeze even at the temperatures of -30°C if the humidity level of the air is appropriate.

## Multi-stage prevention of icing

When air handling units with plate heat exchangers operate in a cold climate zone and when the outside air temperature drops below minus 3–4° C, the heat exchanger starts icing up and therefore periodically needs to be defrosted using the heat of the exhaust air. Heat is lost during these periods, and a more powerful air heater should be installed to compensate these losses. A multi-stage anti-icing system was developed that allows the device to function effectively with a negative outdoor temperature. Its essence is that in case of danger of icing, 2/3 of the surface area of heat exchanger is in normal mode and 1/3 in defrosting mode. After some time, when one segment is thawed, segments change places. Thus, a sufficiently high efficiency is maintained, more thermal energy is saved, without a significant increase in heater power.

Multi-stage prevention of icing





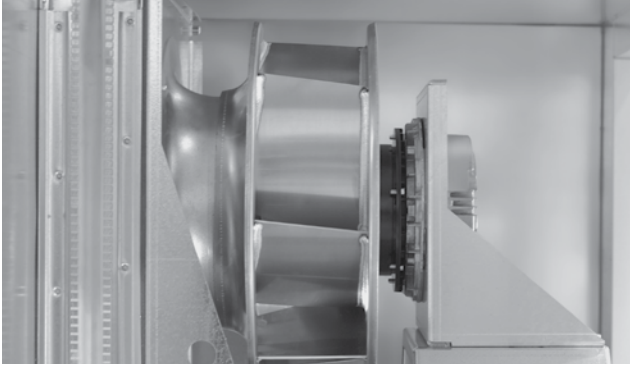

## Fans

In VERS0 series units plug type fans are used, so, units are silent and use electricity effectively. The fans are balanced statically and dynamically, based on the ISO 1940 standard; therefore, unit vibration is minimal and meets all requirements.

When running, fans exhibit the following qualities:

- Very high efficiency coefficient
- Frequency converters ensure an optimal capacity
- Good acoustic performance
- Longevity: a fan is directly connected to the electric motor, so, there is no a belt gear that simplifies maintenance.
- There is a possibility of installing an air flow measuring device

Two types of fan motors are available – three-phase permanent magnet synchronous motors (PM) (400 V, 50 Hz), controlled by frequency converters, or electronically commutated (EC) with an integrated electronic controller with 20-100% speed regulation. Safety category – IP55 according to IEC 34-5. Windings insulation category – F. Maximum operating temperature is 40°C.

### PM motors

- Highest energy efficiency – 93%.
- Ultra Premium IE5 performance class according to IEC.
- Compact dimensions and low weight.
- Wide range of regulation while maintaining high performance.
- Low heat dissipation.
- Reliability and durability.
- The shortest payback time.

### Fan blowers

- The highest efficiency of the wheel with backward curved blades.
- Static efficiency up to 80%.
- Statically and dynamically balanced in accordance with the standard ISO1940.
- Material – composite, aluminum or painted steel.

### Frequency converters

- High energy efficiency – 97%.
- Low heat dissipation.
- Specially designed algorithms for optimal PM motor control.

PM/EC fans

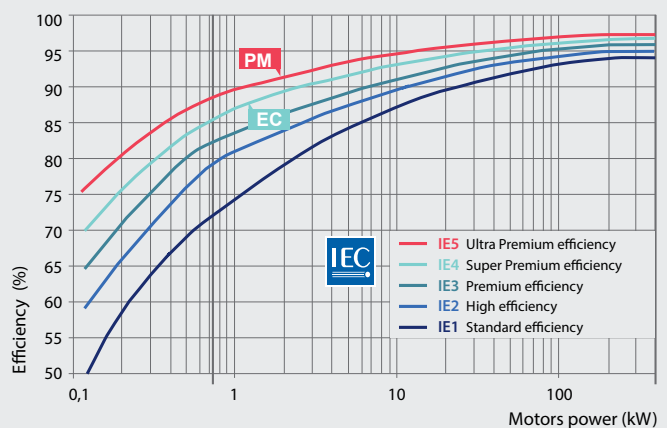
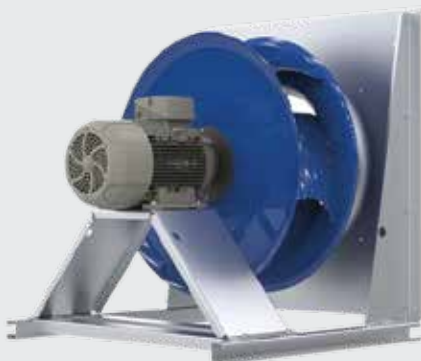



## Air heaters

### Water air heaters

Normally used with aluminium fins and copper pipes. Can be made with a thread joint to connect a freezing sensor. Insulated with a mineral wool heater section mounted on the outside of the unit – room space is saved this way; it is also more convenient to mount it.

- Maximum operating pressure – 21 bars
- Maximum water temperature +100°C (on special order – up to +130°C)
- Heated air temperature – up to +40°C

### Electric air heaters

Stainless steel heating elements are used in production. A three level protection ensures protection from overheating.

- Protection class IP54 in accordance with IEC 34-5.
- Heated air temperature – up to +40°C.

Note: exact electric air heater measurements and other information can be found in VERSO air handling units selection software. The electric heater has its own supply voltage.



## Air coolers

### Water air coolers

Normally used with aluminium fins (spacing 2.5 or 3 mm) and copper pipes. Insulated with a mineral wool heater section mounted on the outside of the unit – room space is saved this way and it is more convenient to mount it.

Maximum operating pressure – 21 bars.

The air cooler section is assembled with a stainless steel sloping drain tray and a water trap.

### Direct evaporation air coolers

Normally used with aluminium fins (spacing 2.5 or 3 mm) and copper pipes. Insulated with a mineral wool heater section mounted on the outside of the unit – room space is saved this way; it is also more convenient to mount it.

Maximum operating pressure – 42 bars.

The cooler section is assembled with a stainless steel sloping drain tray and a water trap. The power of the direct evaporation air cooler can be divided into 2 or 3 steps. It is necessary to indicate this when ordering. DX coil also can operate in heating mode.



### Air dampers

Closing air dampers installed in the air handling units are produced from aluminium with rubber sealing. Connectors – L20. For unit sizes 60, 70, 80 – L30, 90 – L40. Dampers are located outside the unit; they can be made with an insulated damper casing. Standard tightness Class 2, it possible to order higher tightness Class 4 or higher thermal insulation Class 2 TBB.



### Air filters

From G4 to F9 class synthetic or fiberglass pocket type filters are used. Standard length of G4 class filters – 360 mm. Standard length of M5–F9 class filters – 500, 635 mm. The filter clamping mechanism ensures tightness and simplifies the filter replacement procedure. Also G4 or M5 prefilter can be selected on supply air flow.

KOMFOVENT air filters  
correspondence to ISO 1890 standard:

Filter class EN 779:2012	Bag filters ISO 16890
G3 / G4	Coarse 65%
M5	ePM10 60%
F7	ePM1 60%



### Noise reduction sections

To avoid excessive pressure losses inside the air handling unit, duct-mounted sound attenuation sections are offered for VERS0 units. The sound attenuation section of 900 mm length will reduce the noise to air ducts by 15 to 20 dB, a longer section of 1200 mm in length – by 20 to 25 dB. The width and height of these sections correspond to air-handling unit dimensions. The baffler-type sound absorber is installed inside this section. Baffles are filled with special acoustic mineral stone wool and are covered by non-woven glass fibre felt certified to be inside the air duct. Mineral wool can be replaced with polyester wool in the case of a special request. Splitters of the absorber can be easily removed from the section for dry or semi-wet washing for ventilation hygiene purposes.

The efficiency of the channel noise reduction section, in dB

Nr.	Length, mm	Efficiency dB when frequency Hz							
		63	125	250	500	1000	2000	4000	8000
10	900	10	19	27	31	33	32	27	17
	1200	13	26	35	42	44	43	36	22
20	900	6	13	17	21	22	21	18	11
	1200	8	17	23	27	29	28	24	15
30	900	7	13	18	22	23	22	19	12
	1200	9	18	24	29	30	30	25	15
40	900	6	13	18	21	22	21	18	11
	1200	8	17	23	27	29	28	24	15
50	900	6	12	17	20	21	21	18	11
	1200	8	16	22	27	28	27	23	14
60	900	8	15	21	25	26	25	21	13
	1200	10	20	28	33	34	34	28	18
70	900	7	14	20	23	25	24	20	13
	1200	10	19	26	31	33	32	27	17
80	900	7	14	19	23	24	23	20	12
	1200	9	18	25	30	32	31	26	16
90	900	7	14	20	23	25	24	20	13
	1200	10	19	26	31	33	32	27	17



## Casing and outside grilles

Casing and outside grilles can be additionally mounted on the supply and exhaust vents of outdoor air handling units.



## Roof

A roof with water drainage must be additionally installed on outdoor air-handling units.

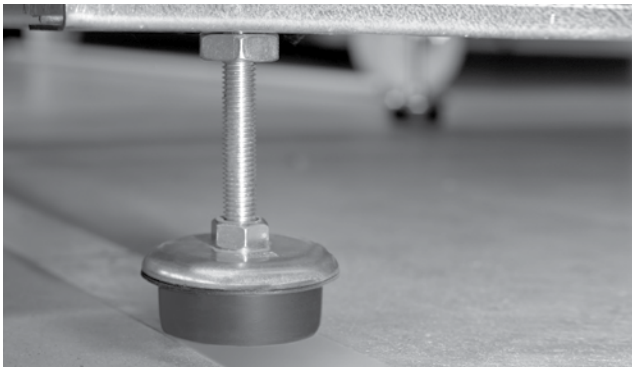

## Height-adjustable feet

The construction frame of the air handling unit with height adjustable feet makes it much easier to level the unit on the site.



## Door locks and handles

Easy to use door locks and handles ensure safe unit maintenance.



## Inspection window and lighting

Internal lighting enables to observe unit's internal operation through an inspection window. Economy light is used with a switch outside the unit.

Inspection window enables you to observe the unit's internal operation. The diameter of the plastic window is 200 mm.

## Dimensions

Modern air handling unit proportions allow reaching better technical parameters: a lower air flow velocity inside the unit, better acoustic data.

### Verso R

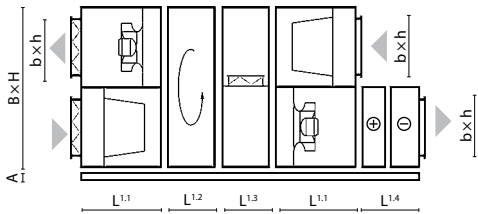

Size	B	H	L <sup>1.1</sup>	L <sup>1.2</sup>	L <sup>1.3</sup>	L <sup>1.4</sup>	b	h	A
10	1000	1000	618	370	435	800	700	300	125
20	1150	1150	751	370	435	800	900	400	125
30	1300	1300	751	370	435	800	1000	500	125
40	1500	1520	751	390	435	800	1200	600	125
50	1700	1715	885	390	435	800	1400	700	125
60	1900	1920	885	390	570	800	1600	800	125
70	2100	2100	885	390	705	800	1800	900	125
80	2300	2420	1250	510	841	830	2000	1000	125
90	2610	2650	1400	550	1040	830	2200	1100	125
100	3770	2420	1250	1400	841	830	3400	1000	125

**Note:** the electric air heaters, water heaters and coolers section length and configuration are noted in the selection programme of VERSO air handling units.

### Verso CF

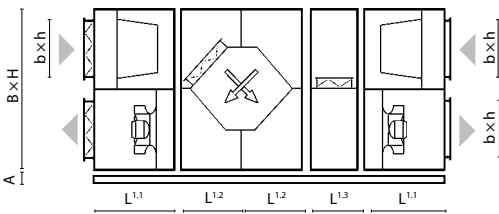

Size	B	H	L <sup>1.1</sup>	L <sup>1.2</sup>	L <sup>1.3</sup>	b	h	A
10	1000	1000	618	570	435	700	300	125
20	1150	1150	751	645	435	900	400	125
30	1300	1300	751	720	435	1000	500	125
40	1500	1520	751	720	435	1200	600	125
50	1700	1715	885	720	435	1400	700	125
60	1900	1920	885	920	570	1600	800	125
70	2100	2100	885	1060	705	1800	900	125
80	2300	2420	1250	1250	841	2000	1000	125
90	2610	2650	1400	1250	1040	2200	1100	125

**Notes:** size 20÷70 plate heat exchanger section is made of two parts. Size 10, 80 and 90 – of one part. The electric air heater section length is noted in the selection programme of VERSO air handling units.

### Verso P

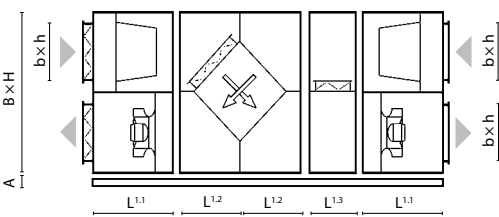

Size	B	H	L <sup>1.1</sup>	L <sup>1.2</sup>	L <sup>1.3</sup>	b	h	A
10	1000	1000	618	422	435	700	300	125
20	1150	1150	751	570	435	900	400	125
30	1300	1300	751	570	435	1000	500	125
40	1500	1520	751	570	435	1200	600	125
50	1700	1715	885	707	435	1400	700	125
60	1900	1920	885	845	570	1600	800	125
70	2100	2100	885	845	705	1800	900	125
80	2300	2420	1250	1150	841	2000	1000	125
90	2610	2650	1400	1150	1040	2200	1100	125

**Notes:** size 20÷70 plate heat exchanger section is made of two parts. Size 10, 80 and 90 – of one part. The electric air heaters, water heaters and coolers section length and configuration are noted in the selection programme of VERSO air handling units.

### Verso S

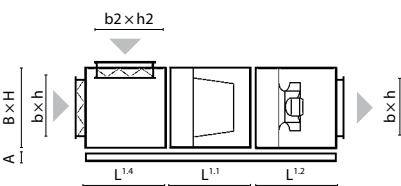

Size	B	H	L <sup>1.1</sup>	L <sup>1.2</sup>	L <sup>1.4</sup>	b	h	b1	h1	b2	h2	A
10	1000	490	750	705	430	900	400	700	300	700	300	125
20	1150	585	750	705	430	1100	500	900	400	1000	300	125
30	1300	660	750	705	470	1200	600	1000	500	1100	400	125
40	1500	740	750	842	470	1400	700	1200	600	1200	400	125
50	1700	890	750	842	470	1600	800	1400	700	1400	400	125
60	1900	960	750	979	570	1800	900	1600	800	1600	500	125
70	2100	1085	750	979	705	2000	1000	1800	900	1800	600	125
80	2300	1235	750	1250	705	2200	1100	2000	1000	2000	600	125
90	2610	1350	750	1400	705	2500	1200	2200	1100	2200	600	125

**Note:** the electric air heaters, water heaters and coolers section length and configuration are noted in the selection programme of VERSO air handling units.



# RHP

Air handling units with integrated heat pump



150 – 25 000 m<sup>3</sup>/h

## All HVAC systems in one unit



**VENTILATION**  
RHP units provide the premises with fresh air consuming minimal power



**HEATING**  
RHP units can efficiently heat the premises especially during a transitional period



**COOLING**  
RHP units provide the most efficient cooling during the summer



**HUMIDITY CONTROL**  
RHP units in summer perform dehumidification and in winter – regeneration of humidity



**AIR FILTRATION**  
Fresh air supplying into room is cleaned from dust



Complete indoor microclimate control:  
**5 in 1**

### Wide possibilities with RHP:

- Unit monitoring and management through the Internet and BMS.
- Extremely high energy efficiency.
- Simple designing, installing, operation and maintenance.
- Shortest payback time.
- Unified smart control, simplified management.
- No outdoor unit, no refrigeration specialists required.

### Integrated control system C5

Automatic system designed for professionals, controls thermodynamic processes and saves energy.

The user is given detailed information about the operation of the unit. Variety of modes and functions allows the user to choose the most optimal operating mode that maximizes energy saving.



## Two-stage heat / cool recovery

### Thermal efficiency over 140%

To reach the maximum efficiency Komfovent RHP units are designed to recover the energy in two steps:

- 1<sup>st</sup> step recovery by enthalpy rotary heat exchanger.
- 2<sup>nd</sup> step recovery by reversible heat pump.

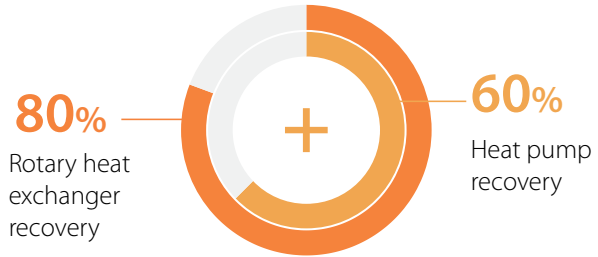

Outdoor: -10°C / 80% RH  
Indoor: +20°C / 40% RH

## Optimised and efficient operating principles:



### Cooling mode

Due to cooling recovery by rotary heat exchanger, the air temperature after the rotor is lower than the outside air temperature. Condensation temperature in this case is lower, which results in reduced compressor electricity consumption compared with outdoor condensing unit.

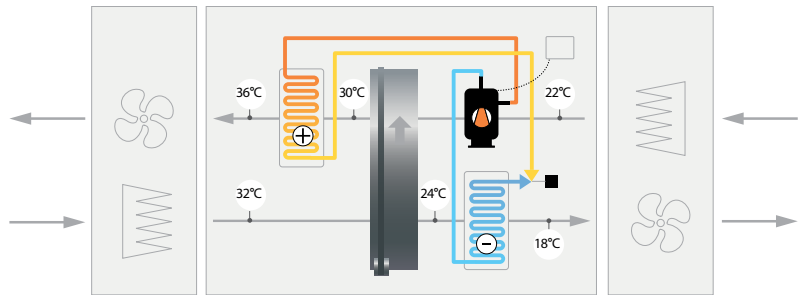

### Heating mode

A highly efficient rotary heat exchanger is used for first-stage heat recovery, recovering the biggest part of the heat of extracted air. For second-stage heat recovery and supply air temperature control, a heat pump is used.

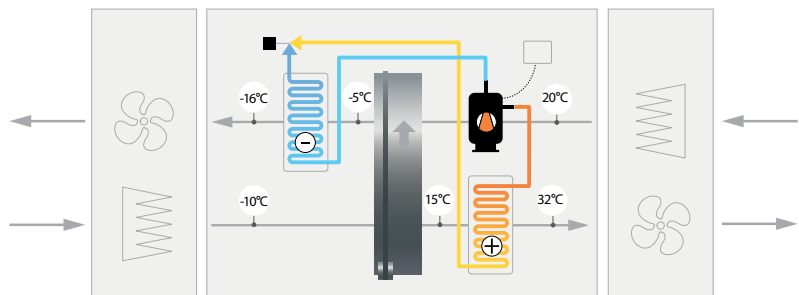

### Operation range:

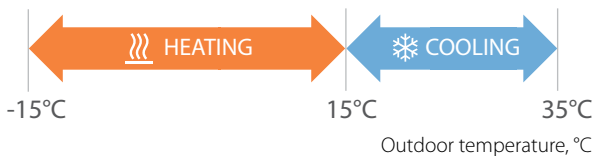

# RHP Standard



## Why choose RHP Standard units?

### Total comfort all year long

Reversible heating and cooling operation of heat pump ensures comfort indoor climate.

### Added value to indoor climate

Heating and humidity recovery in winter, cooling and dehumidifying in summer.

### "All-inclusive" solution

No need for condensing unit, chiller, piping or additional work providing.

### Convenience and safety

Factory-charged with refrigerant; no refrigeration knowledge is needed.

### Eco-friendly and protected

Non ozone depleting refrigerant R134A is used in RHP units and one circuit charge limits are applied.

### Extremely energy-efficient and resource saving

Two-step efficiency is provided by rotary heat exchanger recovery and post heating / cooling operated by a heat pump.

### Factory tested

Reliable and convenient PLUG & PLAY installation, commissioning and exploitation.

### Intelligent control

Clever automatic control algorithms and reliable components ensure safe and efficient equipment operation.

### Extremely compact design

It saves building spaces, easier transportation.

### Exclusive connectivity – 14 ways

(except model RHP 400)

Allows for optimal and rational connection of the ducts.



## Sizes and capacities of RHP units

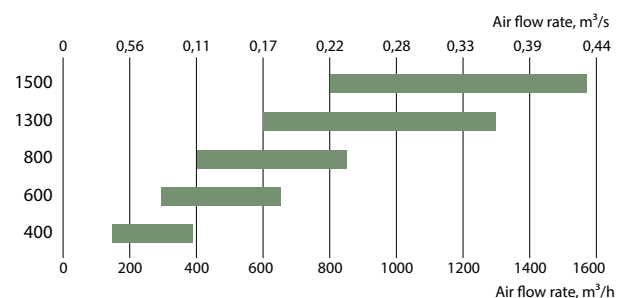

# RHP 400 V

Nominal air flow, m <sup>3</sup> /h	398
Panel thickness, mm	30/50
Unit weight, kg	106
Supply voltage, V	1~230
Maximal operating current, A	6,6 (RHP 2.2/1.4)
Maximal operating current, A	7,7 (RHP 2.8/2.4)
Filters dimensions B×H×L, mm	462×200×46
Electric power input of the fan drive at maximum flow rate, W	103
Electric air heater capacity, kW / Δt, °C	1/7
Refrigerant R134 A, kg	1,1
Control panel	C5.1
Maintenance space, mm	720



The photo is intended for informational purposes only, exact details may vary.

## Acoustic data

A-weighted sound power level  $L_{WA}$ , dB(A)  
at reference flow rate

Supply inlet	59
Supply outlet	74
Exhaust inlet	59
Exhaust outlet	74
Casing	54

A-weighted sound pressure level  $L_{pA}$ , dB(A)

10 m<sup>2</sup> normally isolated room, distance from casing – 3 m.

Surroundings	44
--------------	----

## Temperature efficiency

Outside temperature, °C	Winter					Summer		
	-23	-15	-10	-5	0	25	30	35
After heat exchanger, °C	11,2	13,2	14,4	15,5	16,7	22,7	23,9	25,1

indoor +22°C, 20 % RH.

Shown as right (R1)

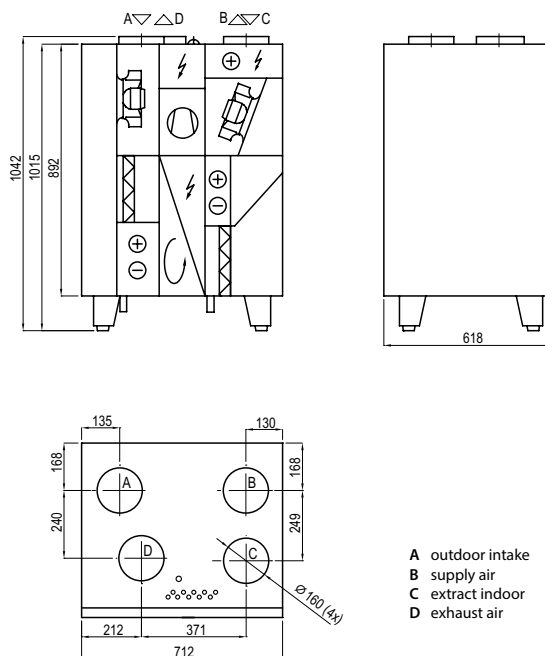

The unit is available only right inspection side.

## Performance

Filter M5, rotary heat exchanger L, heat pump system and electric air heater.

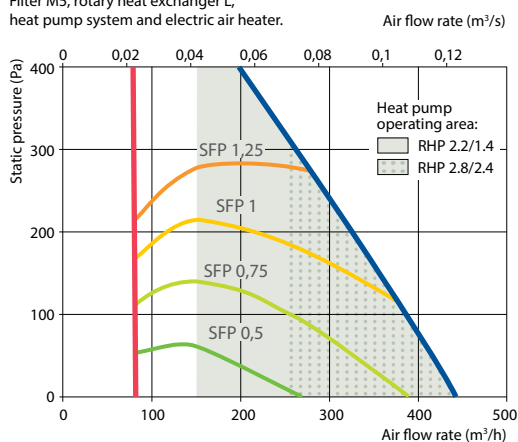

## Accessories (p. 120)

Closing damper	AGUJ-M-160+LM24
Silencer	A/D AGS-160-50-600-M
	B/C AGS-160-50-900-M

**Heating mode**

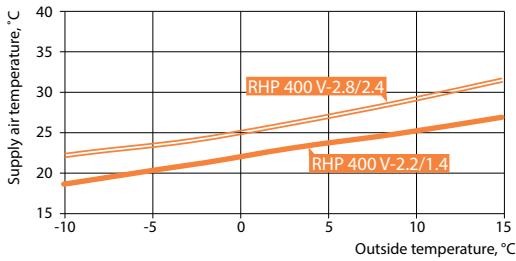

Application: 20 °C, RH 45% indoor.

**Cooling mode**

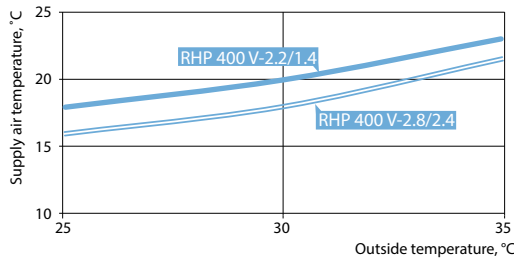

Application: 24 °C, RH 55% indoor.  
Total (heating and cooling) – rotary heat recovery + heat pump.

**Heat pump parameters**

	RHP 400 V-2.2/1.4					RHP 400 V-2.8/2.4				
	Heating			Cooling		Heating			Cooling	
Outdoor temperature, °C	7	2	-7	35	27	7	2	-7	35	27
Outdoor air related humidity, %	86	84	74	40	45	86	84	74	40	45
Indoor air temperature, °C	20	20	20	27	21	20	20	20	27	21
Indoor air related humidity, %	50	50	45	40	50	50	50	45	40	50
Supply air temperature, °C	23,7	21,9	18,6	21,6	15,7	28,2	26,3	22,4	19,1	13,9
Heat pump heating/cooling power, kW	0,89	0,81	0,68	1,2	1,33	1,5	1,4	1,18	1,97	1,85
Heat pump heating/cooling power consumption, kW	0,2	0,2	0,17	0,22	0,19	0,45	0,42	0,37	0,49	0,42
System SCOP <sup>1,2,3</sup> , Average climate / System SEER <sup>1,2,3</sup>	13,4			4,0		7,2			3,45	
COP/EER	4,31	4,09	3,87	4,46	5,80	3,35	3,28	3,20	3,07	3,38

<sup>1</sup> Rotary heat exchanger wave size "L"  
<sup>2</sup> Rotary heat exchanger + heat pump  
<sup>3</sup> According to EN 14825 standard

# RHP 600 U

Nominal air flow, m <sup>3</sup> /h	650
Panel thickness, mm	50
Unit weight, kg	194
Supply voltage, V	1~230
Maximal operating current, A	9,6 (RHP 3.7/3)
Maximal operating current, A	10,5 (RHP 4.4/3.8)
Filters dimensions B×H×L, mm	500×280×46
Electric power input of the fan drive at maximum flow rate, W	128
Electric air heater capacity, kW / Δt, °C	1 / 4,3
Refrigerant R134 A, kg	2,2
Control panel	C5.1
Maintenance space, mm	600



The photo is intended for informational purposes only, exact details may vary.

## Acoustic data

A-weighted sound power level  $L_{WA}$ , dB(A)  
at reference flow rate

Supply inlet	57
Supply outlet	70
Exhaust inlet	59
Exhaust outlet	69
Casing	52

A-weighted sound pressure level  $L_{pA}$ , dB(A)

10 m<sup>2</sup> normally isolated room, distance from casing – 3 m.

Surroundings	41
--------------	----

## Temperature efficiency

Outside temperature, °C	Winter					Summer		
	-23	-15	-10	-5	0	25	30	35
After heat exchanger, °C	13,9	15,3	16,2	17,1	18,0	22,5	23,4	24,4

indoor +22°C, 20 % RH.

## Performance

Filter M5, rotary heat exchanger L, heat pump system and electric air heater.

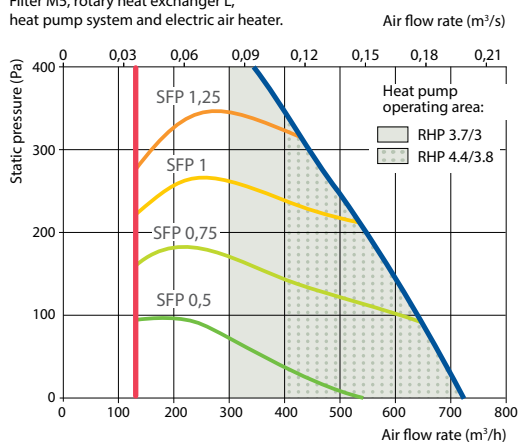

Shown as right (R1)

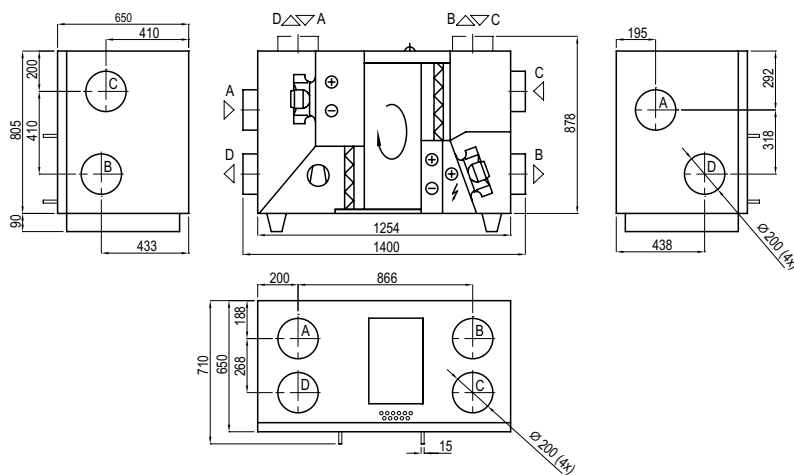

Shown as left (L1)

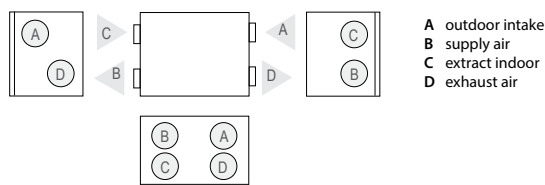

## Accessories (p. 120)

Closing damper	AGUJ-M-200+LM24
Silencer	A/D AGS-200-50-600-M
	B/C AGS-200-50-900-M

**Heating mode**

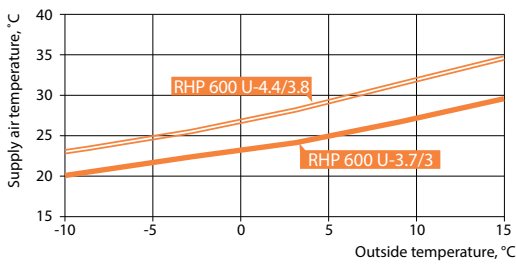

Application: 20 °C, RH 45% indoor.

**Cooling mode**

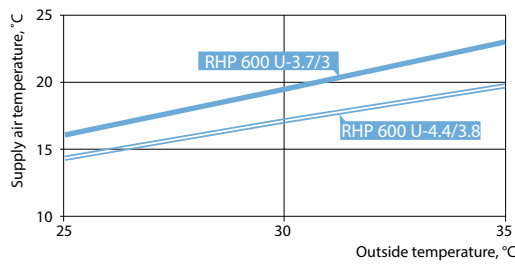

Application: 24 °C, RH 55% indoor.  
Total (heating and cooling) – rotary heat recovery + heat pump.

**Heat pump parameters**

	RHP 600 U-3.7/3					RHP 600 U-4.4/3.8				
	Heating			Cooling		Heating			Cooling	
Outdoor temperature, °C	7	2	-7	35	27	7	2	-7	35	27
Outdoor air related humidity, %	86	84	74	40	45	86	84	74	40	45
Indoor air temperature, °C	20	20	20	27	21	20	20	20	27	21
Indoor air related humidity, %	50	50	45	40	50	50	50	45	40	50
Supply air temperature, °C	27,9	26,1	22,5	18	15,1	32,1	29,8	25,6	16,6	11,5
Heat pump heating/cooling power, kW	1,66	1,53	1,25	1,76	1,84	2,33	2,11	1,73	2,15	2,15
Heat pump heating/cooling power consumption, kW	0,4	0,38	0,34	0,49	0,38	0,62	0,58	0,52	0,73	0,62
System SCOP <sup>1,2,3</sup> , Average climate / System SEER <sup>1,2,3</sup>	13,3			4,52		9,7			4,7	
COP/EER	4,19	3,97	3,61	4,5	4,83	3,66	3,5	3,27	3,06	3,48

<sup>1</sup> Rotary heat exchanger wave size "L"  
<sup>2</sup> Rotary heat exchanger + heat pump  
<sup>3</sup> According to EN 14825 standard

# RHP 800 U

Nominal air flow, m <sup>3</sup> /h	800
Panel thickness, mm	50
Unit weight, kg	255
Supply voltage, V	3~400
Maximal operating current, A	14,8 (RHP 5.3/4.7)
Maximal operating current, A	16,1 (RHP 6.1/5.8)
Filters dimensions B×H×L, mm	750×400×46
Electric power input of the fan drive at maximum flow rate, W	127
Electric air heater capacity, kW / Δt, °C	2 / 6,9
Refrigerant R134 A, kg	3,1
Control panel	C5.1
Maintenance space, mm	800



The photo is intended for informational purposes only, exact details may vary.

### Acoustic data

A-weighted sound power level  $L_{WA}$ , dB(A)  
at reference flow rate

Supply inlet	59
Supply outlet	72
Exhaust inlet	59
Exhaust outlet	69
Casing	51

A-weighted sound pressure level  $L_{pA}$ , dB(A)

10 m<sup>2</sup> normally isolated room, distance from casing – 3 m.

Surroundings	40
--------------	----

### Performance

Filter M5, rotary heat exchanger L, heat pump system and electric air heater.

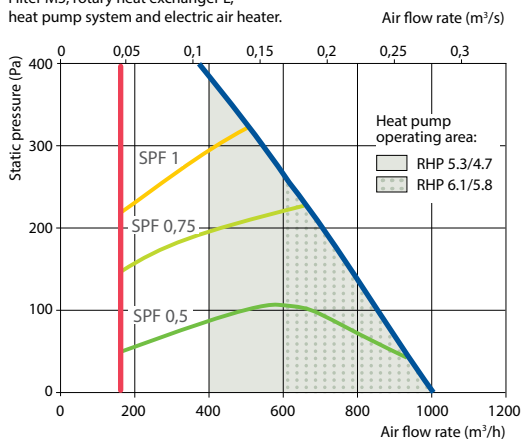

### Temperature efficiency

Outside temperature, °C	Winter					Summer		
	-23	-15	-10	-5	0	25	30	35
After heat exchanger, °C	15,5	16,7	17,4	18,1	18,8	22,4	23,2	23,9

indoor +22°C, 20 % RH.

Shown as right (R1)

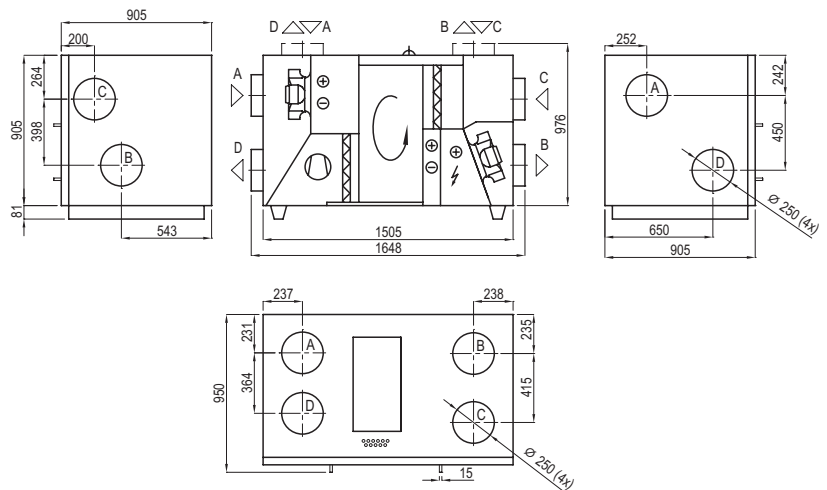

Shown as left (L1)

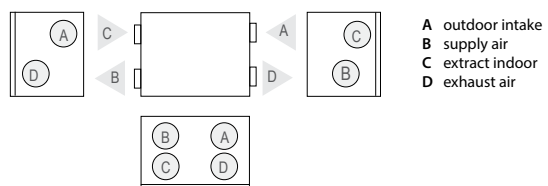

### Accessories (p. 120)

Closing damper	AGUJ-M-250+LM24
Silencer	A/D AGS-250-50-600-M
	B/C AGS-250-50-900-M



**Heating mode**

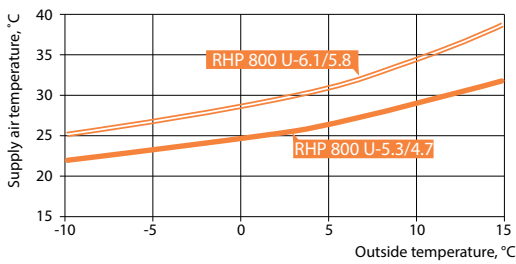

Application: 20 °C, RH 45% indoor.

**Cooling mode**

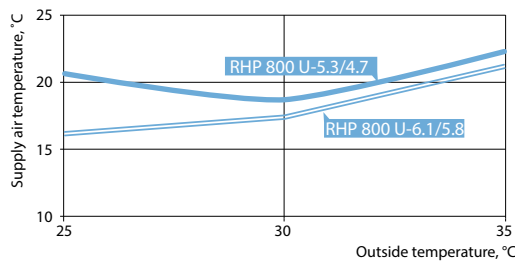

Application: 24 °C, RH 55% indoor.  
Total (heating and cooling) – rotary heat recovery + heat pump.

**Heat pump parameters**

	RHP 800 U-5.3/4.7					RHP 800 U-6.1/5.8				
	Heating			Cooling		Heating			Cooling	
Outdoor temperature, °C	7	2	-7	35	27	7	2	-7	35	27
Outdoor air related humidity, %	86	84	74	40	45	86	84	74	40	45
Indoor air temperature, °C	20	20	20	27	21	20	20	20	27	21
Indoor air related humidity, %	50	50	45	40	50	50	50	45	40	50
Supply air temperature, °C	29,3	27,4	23,5	17,4	11,6	32,9	30,4	26,5	15,6	10,6
Heat pump heating/cooling power, kW	2,45	2,26	1,82	2,38	2,45	3,19	2,89	2,44	2,95	2,91
Heat pump heating/cooling power consumption, kW	0,56	0,54	0,44	0,69	0,59	0,85	0,8	0,66	1,05	0,91
System SCOP <sup>1,2,3</sup> , Average climate / System SEER <sup>1,2,3</sup>	12,7			4,65		9,4			4,6	
COP/EER	4,28	4,08	4,05	3,53	4,03	3,63	3,53	3,67	2,85	3,24

<sup>1</sup> Rotary heat exchanger wave size "L"  
<sup>2</sup> Rotary heat exchanger + heat pump  
<sup>3</sup> According to EN 14825 standard

# RHP 1300 U

Nominal air flow, m <sup>3</sup> /h	1200
Panel thickness, mm	50
Unit weight, kg	260
Supply voltage, V	3~400
Maximal operating current, A	18,2 (RHP 8.1/6.6)
Maximal operating current, A	20,5 (RHP 9.2/7.6)
Filters dimensions B×H×L, mm	750×400×46
Electric power input of the fan drive at maximum flow rate, W	253
Electric air heater capacity, kW / Δt, °C	2/4,6
Refrigerant R134 A, kg	3,1
Control panel	C5.1
Maintenance space, mm	800



The photo is intended for informational purposes only, exact details may vary.

### Acoustic data

A-weighted sound power level  $L_{WA}$ , dB(A)  
at reference flow rate

Supply inlet	64
Supply outlet	78
Exhaust inlet	64
Exhaust outlet	76
Casing	56

A-weighted sound pressure level  $L_{pA}$ , dB(A)

10 m<sup>2</sup> normally isolated room, distance from casing – 3 m.

Surroundings	45
--------------	----

### Temperature efficiency

Outside temperature, °C	Winter					Summer		
	-23	-15	-10	-5	0	25	30	35
After heat exchanger, °C	14,5	15,8	16,7	17,5	18,3	22,5	23,3	24,2

indoor +22°C, 20 % RH.

### Performance

Filter M5, rotary heat exchanger L, heat pump system and electric air heater.

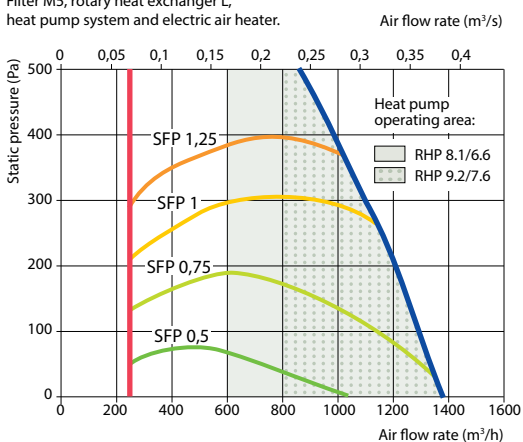

Shown as right (R1)

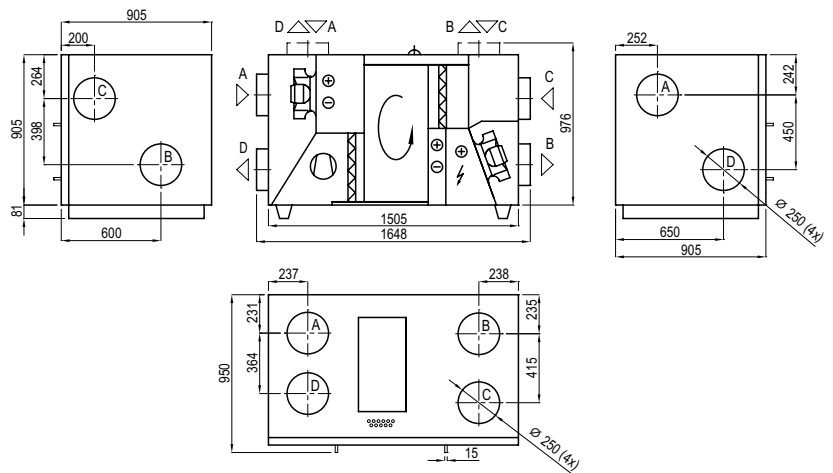

Shown as left (L1)

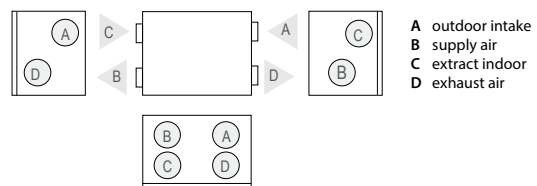

- A outdoor intake
- B supply air
- C extract indoor
- D exhaust air

### Accessories (p. 120)

Closing damper	AGUJ-M-250+LM24
Silencer	A/D AGS-250-50-600-M
	B/C AGS-250-50-900-M

**Heating mode**

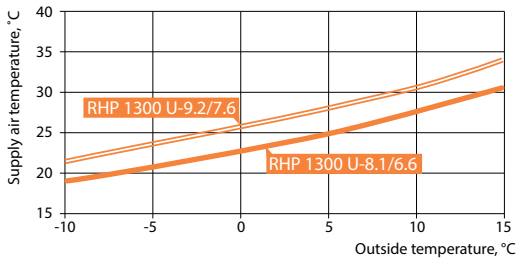

Application: 20 °C, RH 45% indoor.

**Cooling mode**

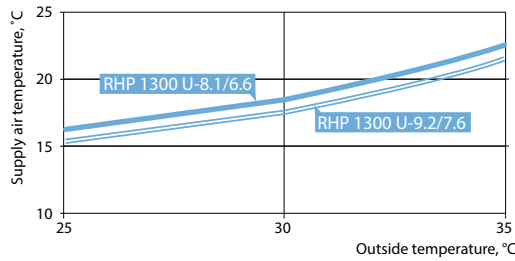

Application: 24 °C, RH 55% indoor.  
Total (heating and cooling) – rotary heat recovery + heat pump.

**Heat pump parameters**

	RHP 1300 U-8.1/6.6					RHP 1300 U-9.2/7.6				
	Heating			Cooling		Heating			Cooling	
Outdoor temperature, °C	7	2	-7	35	27	7	2	-7	35	27
Outdoor air related humidity, %	86	84	74	40	45	86	84	74	40	45
Indoor air temperature, °C	20	20	20	27	21	20	20	20	27	21
Indoor air related humidity, %	50	50	45	40	50	50	50	45	40	50
Supply air temperature, °C	26,4	24,6	21,3	19,70	13,80	28,5	26,4	22,9	18,50	13,10
Heat pump heating/cooling power, kW	3,69	3,4	2,8	3,67	3,57	4,55	4,13	3,46	4,4	4,36
Heat pump heating/cooling power consumption, kW	0,8	0,69	0,7	0,94	0,84	1,15	1,09	0,92	1,37	1,2
System SCOP <sup>1,2,3</sup> , Average climate / System SEER <sup>1,2,3</sup>	12,9			4,65		9,6			4,62	
COP/EER	4,43	4,91	3,89	3,98	5,10	3,83	3,7	3,75	3,42	3,69

<sup>1</sup> Rotary heat exchanger wave size "L"  
<sup>2</sup> Rotary heat exchanger + heat pump  
<sup>3</sup> According to EN 14825 standard

# RHP 1500 U

Nominální vzduchové množství v m <sup>3</sup> /h	1400
Tloušťka panelu, mm	50
Hmotnost jednotky, kg	260
Přívodní napětí, V	3~400
Maximální provozní proud, A	21,9
Rozměry filtrů Š×V×D, mm	750×400×46
Elektrický příkon ventilátoru při maximálním vzduchovém množství, W	263
Výkon elektrického ohřívače v kW / Δt, °C	2/4
Chladivo R134 A, kg	3,1
Ovladač	C5.1
Montážní prostor, mm	800



Tato fotografie je určena pouze k informativním účelům, v detailech se může lišit.

## Akustická data

A-vážený akustický výkon  $L_{WA}$ , dB(A) při referenčním vzduchovém množství

Vstup přívodu	59
Výstup přívodu	73
Vstup odtahu	60
Výstup odtahu	71
Opláštění	54

A-vážený akustický tlak  $L_{PA}$ , dB(A)

v běžně utěsněné 10 m<sup>3</sup> místnosti ve vzdálenosti 3 m od opláštění

Okolí	44
-------	----

## Výkon

Filtr M5, rotační tepelný výměník L, systém tepelného čerpadla a elektrický ohřívač vzduchu Vzduchový průtok (m<sup>3</sup>/s)

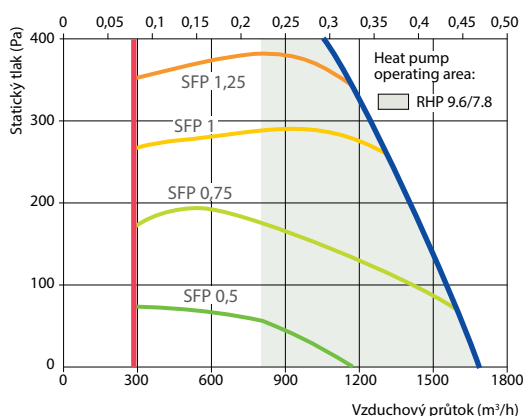

## Tepelná účinnost

Venková teplota v °C	Zima					Léto		
	-23	-15	-10	-5	0	25	30	35
Za výměníkem, °C	14,0	15,4	16,3	17,2	18,1	22,5	23,4	24,3

vnitřní +22°C, 20 % RH.

Shown as right (R1)

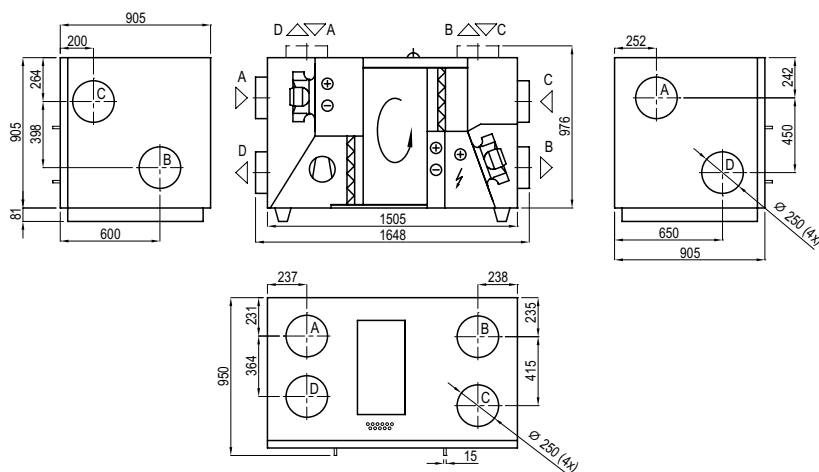

Shown as left (L1)

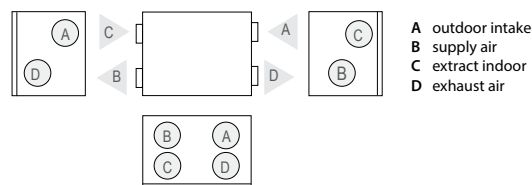

## Příslušenství (s. 120)

Uzavírací klapka	AGUJ-M-250+LM24
Tlumič	A/D AGS-250-100-600-M
	B/C AGS-250-100-900-M

### Heating mode

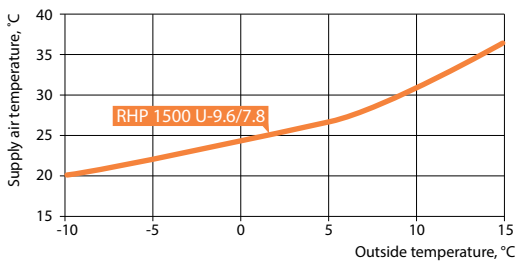

Application: 20°C, RH 45% indoor.

### Cooling mode

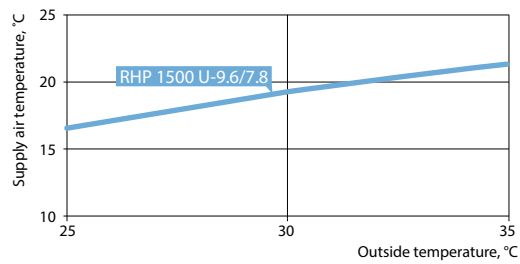

Application: 24°C, RH 55% indoor  
Total (heating and cooling) – rotary heat recovery + heat pump.

### Heat pump parameters

	RHP 1500 U 9.6/7.8				
	Heating			Cooling	
Outdoor temperature, °C	7	2	-7	35	27
Outdoor air related humidity, %	86	84	74	40	45
Indoor air temperature, °C	20	20	20	27	21
Indoor air related humidity, %	50	50	45	40	50
Supply air temperature, °C	27	25	21,5	19,6	13,7
Heat pump heating/cooling power, kW	4,71	4,3	3,57	4,51	4,7
Heat pump heating/cooling power consumption, kW	1,14	0,98	0,99	1,34	1,16
System SCOP <sup>1,2,3</sup> , Average climate / System SEER <sup>1,2,3</sup>		10,6		3,9	
COP/EER	4,01	4,37	3,52	3,67	3,94

<sup>1</sup> Rotary heat exchanger wave size "L"

<sup>2</sup> Rotary heat exchanger + heat pump

<sup>3</sup> According to EN 14825 standard

# RHP Pro



## Advantages of RHP Pro units

### PLUG & PLAY control system C5

Benefits: real air flow indication; thermal efficiency of the rotary heat exchanger indication; heat exchanger recovery in kW; thermal energy saving factor, SFP factor of the fans and other important information about the functioning of the unit.

### Inverter compressors

Energy-efficient and silent inverter compressors enable accurate regulation and maintenance of supply air temperature.

### Electronic expansion valve

For power adjustment of the integrated heat pump use an electronic EEV (electronic expansion valve), which ensures a stable supply air temperature and allows a wide range of regulation of device performance and heating/cooling capacity.

### Sorption rotary heat exchanger

In RHP units sorption rotary regenerators with special 4Å zeolite coating are used, which because of their hygroscopic selective features ensure good heat and humidity exchange, so the RHP units maintain an optimum indoor climate with minimal energy consumption.

### Air filters

All units are equipped with a large surface area air filters with low pressure loss, it saves energy, replacement can be less often.

### PM/EC fan motors

In RHP PRO units PM (permanent magnet) and EC (electronically commutated) fan motors are used, the most efficient on the market, conforming *Ultra Premium* IE5 or *Super Premium* IE4 efficiency class.

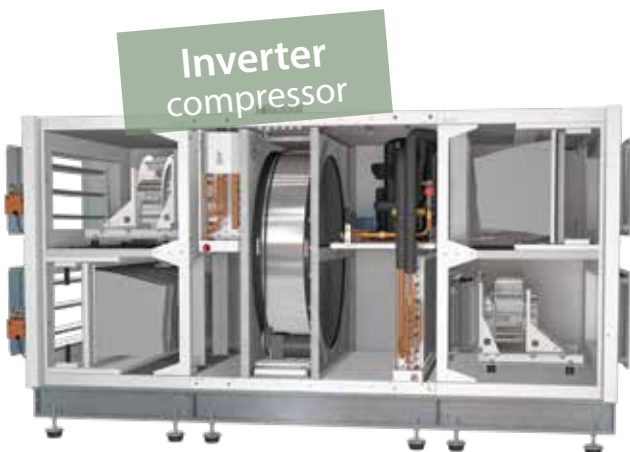

## Sizes and capacities of RHP Pro units

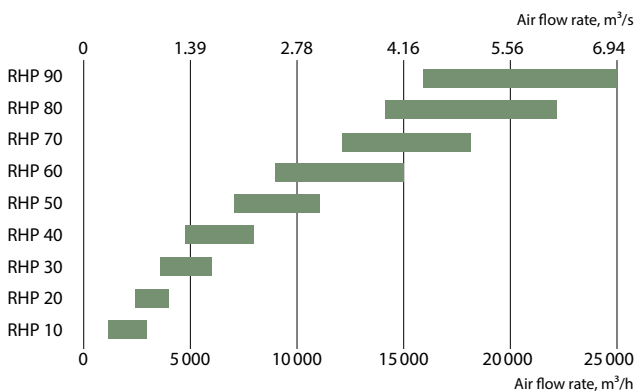

Outdoor	Indoor	Size	RHP 10	RHP 20	RHP 30	RHP 40	RHP 50	RHP 60	RHP 70	RHP 80	RHP 90
		Max air flow, m <sup>3</sup> /h	2800	4000	6000	8000	11000	15000	18000	22000	25000

**Heating mode**

T <sup>1</sup> , °C	-7	20	Total heating capacity, kW	34	48	68	96	123	161	197	234	277
RH <sup>1</sup> , %	90	40	Supply temperature, °C	24,0								
			Nominal compressor power consumption, kW	2,8	3,9	4,6	8,2	7,4	7,7	10,5	13,3	16,2
			System COP <sup>2,3</sup> , kW/kW	9,7	10,4	12,8	10,8	15,1	19,2	17,4	16,7	16,3

**Cooling mode**

T <sup>1</sup> , °C	35	27	Total cooling capacity, kW	18	26	50	54	73	93	115	127	154
RH <sup>1</sup> , %	40	50	Supply temperature, °C	20								
			Nominal compressor power consumption, kW	2,7	3,9	7,2	8,8	11,4	12,1	16,2	18,2	23,3
			System EER <sup>2,3</sup> , kW/kW	5,3	5,5	6,3	5,6	6,0	7,2	6,8	6,7	6,4

- <sup>1</sup> – Conditions according to EN14511
- <sup>2</sup> – Rotary heat exchanger wave size "L"
- <sup>3</sup> – Rotary heat exchanger + heat pump
- <sup>4</sup> – According to EN 14825 standard
- T – temperature, °C
- RH – relative humidity, %

**Device management schedule**

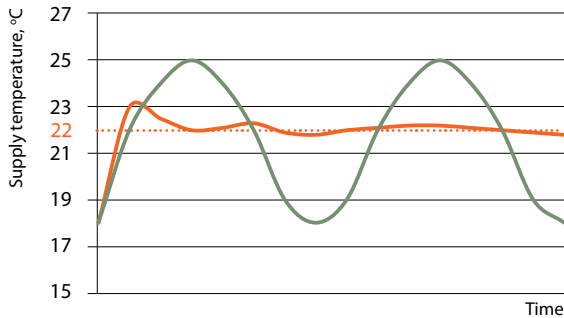

Variable speed compressors are designed in RHP Pro units. The major benefit of this type of compressor are their flexibility. The rotation speed of the compressor varies, as a result less energy is used and the minor temperature changes occur on the premises.

- ..... Setpoint
- Constant speed compressor
- Variable speed compressor

**Dimensions**

Size	B	H	L <sup>1.1</sup>	L <sup>1.2</sup>	L <sup>1.3</sup>	b	h	A
10	1000	1000	618	900	250	700	300	125
20	1150	1150	751	900	250	900	400	125
30	1300	1300	751	900	250	1000	500	125
40	1500	1520	751	900	250	1200	600	125
50	1700	1715	885	900	250	1400	700	125
60	1900	1920	885	900	250	1600	800	125
70	2100	2100	885	900	250	1800	900	125
80	2300	2420	1250	1500	–	2000	1000	125
90	2610	2650	1400	1500	–	2200	1100	125

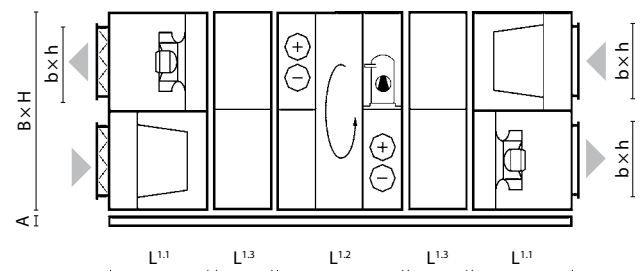

**Note:** the electric air heaters, water heaters and coolers section length and configuration are noted in the selection program of VERSO air handling units.



# KLASIK

Industrial / commercial buildings ventilation units

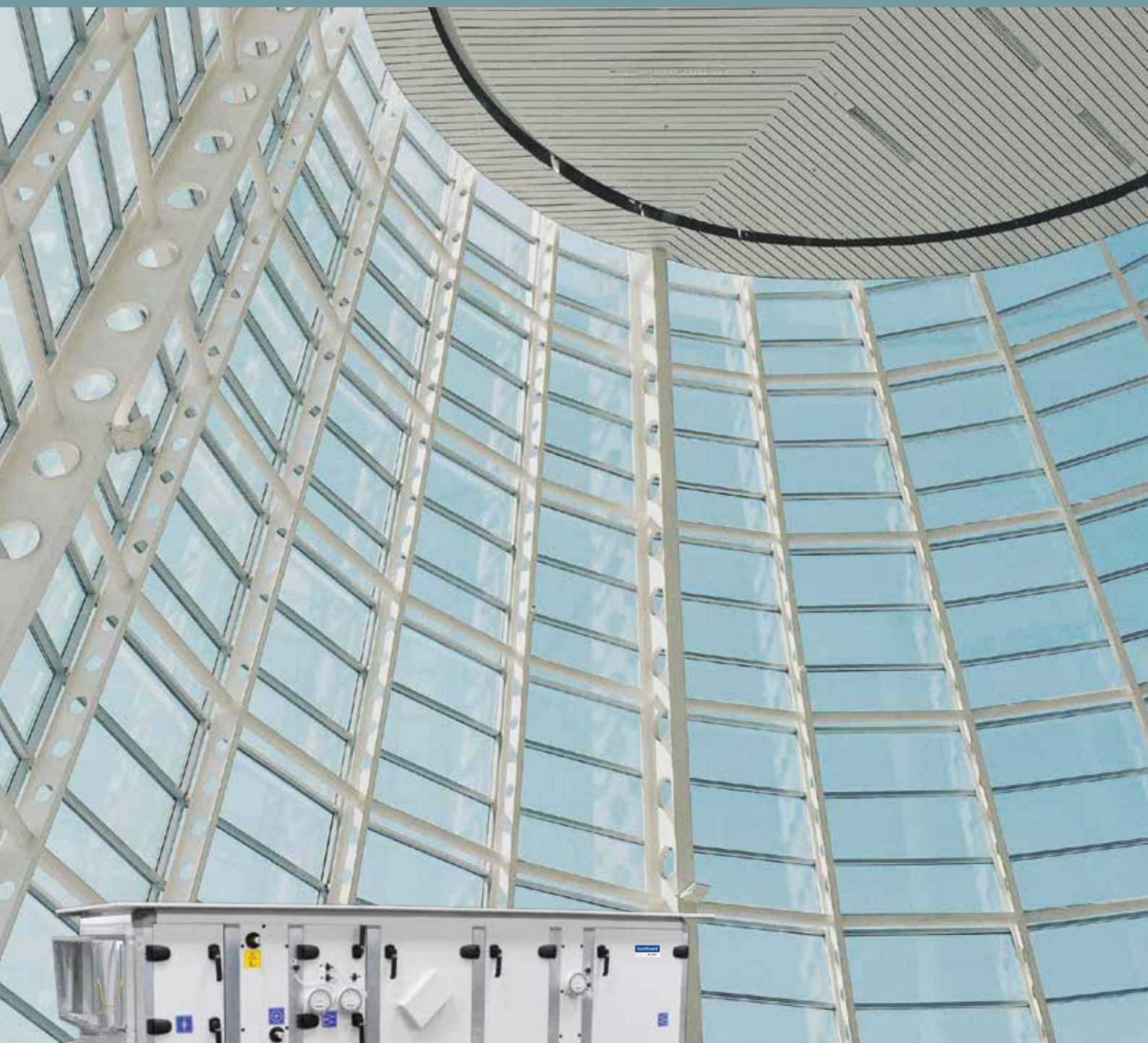

1000 – 100 000 m<sup>3</sup>/h



### Sophisticated technical solutions

The KLASIK series is intended to provide complex solutions and meet all the technological requirements.

### Wide range

The KLASIK series offers a variety of modifications: a wide range of performance; rotary, plate or counterflow heat exchangers; water or freon heater / cooler; gas or electric heaters; adiabatic humidifier.

### The widest range of options

KLASIK selection software offers the widest range of options – the dimensions of the equipment, the design solutions, the technical parameters of the heat exchangers, fans and other elements are presented there.

### Modular construction

KLASIK units consist of modules, as a result the transportation and installation of the unit is facilitated.

### Integrated control system C5

KLASIK units can be ordered with integrated automatic system C5 designed for professionals to control thermodynamic processes and save energy.

The user is given detailed information about the operation of the unit. The variety of modes and functions allows the user to choose the optimal operating mode that maximizes energy saving.

### Energy saving components

It is possible to choose the most efficient components – non-freezing condensing or sorption rotary heat exchanger, counterflow plate heat exchanger, *Super Premium* IE4 class EC fans or *Ultra Premium* IE5 class PM fan.

### Conformity with international standards

All KLASIK units are designed and made according LST, EN (EN 13053, EN 13779, EN 1886), VDI (VDI 6022, VDI 3803/1), RLT (RLT 01) standards.

### Quality certificates

KLASIK selection software and units are tested in the largest independent laboratories: Eurovent, TÜV, RLT.



# KLASIK

## air handling units

### Sizes and capacities of KLASIK units

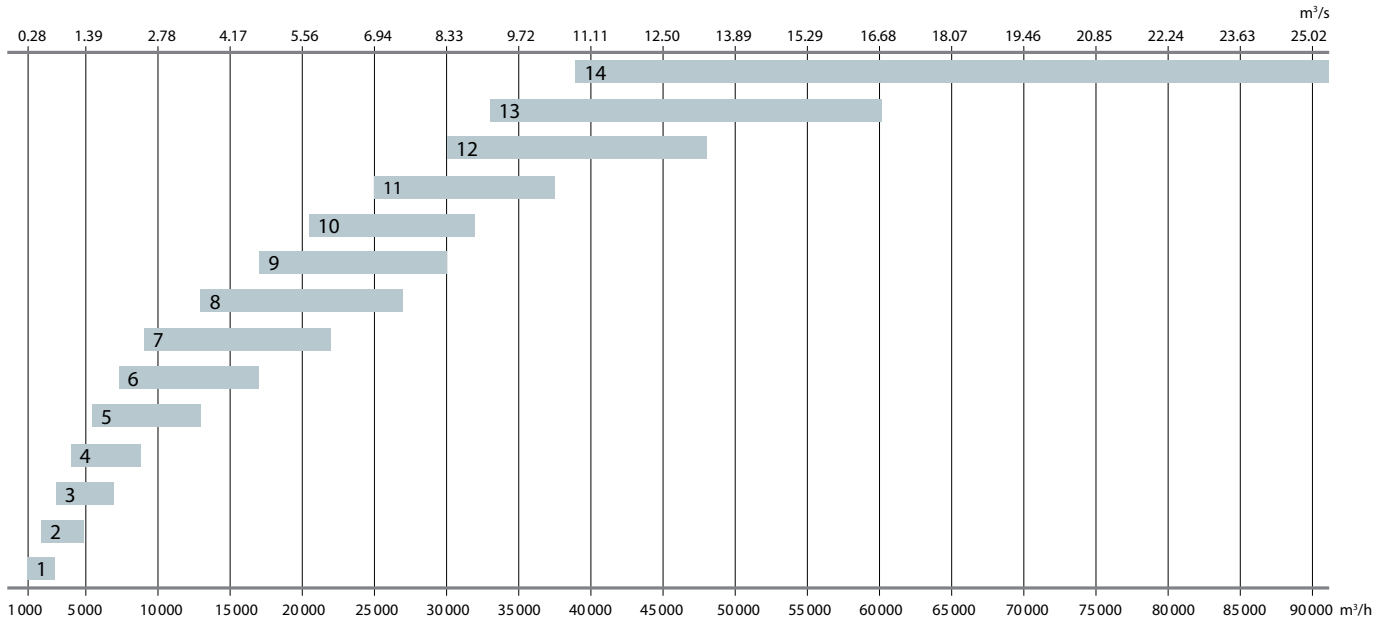

### Selection software

The KLASIK air handling unit software is designed to select the most sophisticated units with specific requirements. The widest selection of components: heat exchangers – rotary, plate cross and counter-flow, run around; heaters – electric, water, DX and gas, coolers – water, DX and adiabatic.

The dimensions of the unit and other technical characteristics can be precisely adjusted according to the project requirements.



### Control system C5



KLASIK air handling units can be ordered with an integrated and factory-tested C5 control system or order only automation box, which will be installed in the object. Automatic system C5 is designed for all thermodynamic processes (heating, cooling, ventilation, humidification, drainage) and has many safety and energy saving features (CAV, VAV, DCV, timers, control according to temperature, humidity, CO<sub>2</sub> or air quality sensors).

## Unit types

### Klasik R

Air handling units with a rotary heat exchanger. Temperature efficiency and energy saving up to 86 %. On request, a low profile with two parallel rotors can be manufactured.



### Klasik CF

Air handling units with a counterflow plate heat exchanger. Temperature efficiency and energy saving up to 92 % in wet conditions and up to 88 % in dry conditions. Upon request, it is possible to manufacture a low profile with fan / filters sections located side by side.



### Klasik P

Air handling units with a cross-flow plate heat exchanger. Temperature efficiency and economy of energy up to 75 % wet. The units can be used for the heat utilization of technological equipment. There is a wide selection of different efficiency and pressure drop heat exchangers.



### Klasik S

Supply or exhaust air handling unit without heat recovery. On request, explosion-, corrosion- or high-temperature-resistant units can be ordered.



\*The photo is intended for informational purposes only, exact details may vary.



## Klasik Hg units for hygienic application

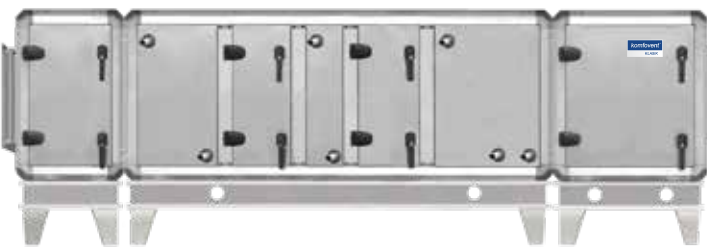

RLT01 general requirements for hygienic application units

General requirements	Mechanical performance	Performance data	Hygiene requirements
EN 13053	EN 13053	EN 13053	EN 13053VDI
EN 16798-3	DIN 1751	EN 16798-3	6022
VDI 3803-1	EN 13501-1	VDI 3803-5	DIN 1946/4
RLT01	RLT01	RLT 01	RLT01

### Purpose

Hygienic AHU's are used in cases when standard execution equipment does not meet the requirements and standards for hygienic equipment. It may be ventilation equipment for areas such as hospitals, clinics, surgical and outpatient clinics centres, medical products, pharmaceutical manufacturing chemicals and the pharmaceutical industry.

### Casing

- Double-sealed panels filled with insulating material.
- Insulation class A1 or A2-s1 d0.
- All materials used are durable, with no accumulated humidity that might provide a supportive medium for microorganisms reproduction.
- Interior surfaces are smooth, without adsorption properties. No porous materials are used.
- Mechanical resistance not less than D2 class.
- Tightness is not worse than class L3 (leakage allowed not more than 2 % of the nominal air flow).
- The passage through the F7 air filters shall not exceed 2 % of the nominal air flow.
- Thermal conductivity is not higher than T4.
- Cold bridges are no worse than TB3.

### Air filters

- Only filters that are tested in accordance with EN 779 or EN 1822 can be used.

- Each filter must be marked accordingly. Recommended is class ISO ePM2,5  $\geq$  50 % in the extract air before the heat recovery unit. In case of single-stage supply air filtering min. ISO ePM1  $\geq$  50 %.
- The surface of the bag-type air filter must have at least 10 m<sup>2</sup> for 1 m<sup>2</sup> openings the area.
- Max. permitted maximum final pressure loss:  
Filter class ISO ePM1  $\geq$  70 % 300 Pa.  
Filter class ISO ePM1  $\geq$  50 % 200 Pa.  
Filter class ISO ePM2,5  $\geq$  50 % 200 Pa.  
Filter class ISO ePM10  $\geq$  50 % 200 Pa.

### Heat exchangers

- The system for supplying and discharging air should be recuperated, except where there is not enough room for it or the payback time is too long.
- Depending on the quality of the exhaust air quality, such types of heat exchangers are recommended: ETA2 – rotary or plate with overpressure; ETA3 – rotary or plate with overpressure; ETA4 – Separate Flow (Run Around coil) or Heat Pipe.
- A stainless steel or aluminum condensate tray is designed. Rotary heat exchanger condensate tray is necessary in exceptional cases.
- To reduce the need for frost it is recommended to use adiabatic cooling by humidifying exhaust air.
- A rotor is recommended to be fitted with a purge section.

### Dampers

- Air leakage class 2 for dampers that are closed while the system is in operation, e.g. mixing dampers or bypass dampers.
- Air velocity for dampers max. 8 m/s (except recirculation air and bypass dampers).
- The position of the damper must be visible from the outside of the damper.

### Cooling coils

- Installation rails for cooling coils in stainless steel or aluminium.
- Condensate tray in stainless steel or aluminium.
- Minimum fin spacing: 2 mm for cooling coil without dehumidification; 2.5 mm for cooling coil with dehumidification.

### Fans

- Fans with backward curved blades are preferred. Energy saving motors are recommended.
- Fan impeller generally protected against corrosion.

- It is recommended to use fans without belt drive (especially open impeller). Base frame of fan and motor in hot-dip galvanized steel sheeting.

### Humidifier section

- Humidifiers must not be placed directly upstream of filters or attenuator (exception: steam humidifiers).
- All components must be demountable. All parts in contact with water to be accessible for inspection and cleaning and consisting of corrosion-resistant and disinfectant resistant material.
- Sealing compounds must not be of material that can be metabolised.

### Sound attenuator section

- Pressure drop max. 80 Pa
- Surface quality material to be permanently abrasion-resistant and made of material that is durable when exposed to cleaning processes (e.g. glass fibre).
- Splitters to be demountable for cleaning without having to remove other parts.

## Klasik Ra units with run around coil heat exchanger



### Specialized pipework package units LCHX for run around coil heat exchangers

- Depending on the operating conditions, the unit is filled with the corresponding concentration of ethylene glycol solution.
- Unit control signal 0 ... 10 V.

#### Maximum performance of the LCHX units

DN (mm)	15	20	25	32	40	50
Flow (m³/h)	0,9	1,8	3,6	6,8	11	18

### Purpose

Ventilation units with separate flow heat exchangers are used in cases where there must be 100% of supplied and discharged air flow separation:

- the discharged air is technologically contaminated with an aggressive, pungent odour or poisonous substances;
- the risk of biological contamination (medical institutions);
- high temperature of exhaust air.

### Advantages

- The supply and exhaust air sections can be separated from each other.
- Compact size.
- The heat exchanger can be integrated into existing supply – exhaust ventilation system.



All photos are informational, details may vary.



## Casing

### Standart

Air handling units of the KLASIK series have a reliable and stable design. Casing frameworks are made of aluminium profiles and solid cast aluminium corner pieces. Covering panels are made of double-skin galvanized or stainless sheet steel.

On request, casing can be painted. Fireproof 50 mm mineral wool is used as a standard.

KLASIK gaskets and sealing are used to ensure perfect casing tightness and sound insulation.

All doors are hinged and equipped with handles which can be locked. Variable accessories such as adjustable feet, inspection windows, sections lighting, etc. are available at the customers' request.

Casing classification in conformance to standard EN 1886: leakage L2; thermal transmittance T3.

### Standart TB

Casing frameworks are made of aluminium profiles and have solid cast aluminium corners with thermal break system. Covering panels are made from double-skin galvanized or stainless sheet. The panels are 60 mm thickness: 50 mm mineral wool are used for thermal and sound insulation and 10 mm of polyurethane foam. Casing classification in conformance with standard EN 1886: leakage L2; thermal transmittance T2; thermal bridging factor TB3.



## Filters

KLASIK units pocket synthetic or fibreglass filters with a class of filtration from G4 up to F9 are used.

Filters have big filtration surface which results in longer terms of exploitation.

Filters are fastened by a clamping mechanism which secures tightness and simplifies the filter replacement procedure.

## Air dampers

Closing air dampers installed in the air handling units are produced from aluminium, or galvanized steel blades with rubber sealing.





## Heat Exchanger

KLASIK air handling units can be supplied with:

### Rotary heat exchanger

Temperature efficiency – up to 86 %. Depending on required temperature efficiency  $\eta$  (%), the height of a wave of a rotor can be made from 1.4 mm up to 1.7 mm.

Rotors may be offered of four types:

- aluminium;
- aluminium with a hygroscopic covering;
- aluminium with an epoxy paint covering on embossed rotor edges;
- aluminium with deep epoxy coating.

The drive of a rotor is supplied with the frequency converter, allowing support for an optimum heat exchanger operating mode, smoothly changing speed of rotation of a rotor. Rotary heat exchanger can be equipped with purge sector on customers' request.

### Counter flow plate heat exchanger

Used in Klasik CF series units. Temperature efficiency factor – up to 92 % in wet conditions and up to 88 % in dry conditions. The plate heat exchanger is equipped with an automatic by-pass. Aluminium plates are made of an aluminium alloy resistant to sea water.

### Plate heat exchanger

Temperature efficiency – up to 75 % wet.

Heat exchanger is tight, both air flows are separated, use of heat of polluted air is possible. Plate heat exchangers with aluminium lamellas are used in KLASIK units.

There is a built-in bypass with damper for heat recovery regulation and exchanger frost protection.

Each unit with plate heat exchanger is equipped with stainless steel sloping drain tray and water trap.

### Run around heat exchanger

Temperature efficiency – up to 70%.

In such system warming up the air exchanger is placed in the supply air and the cooling one – in the exhaust air.

Exchangers are connected with pipes and in this contour water and glycol solution is circulating. Air handling units with such heat recovery are used in cases when air streams must be absolutely separated or when on design features or other requirements the unit must be installed on different floors. Heat exchangers are made of copper pipes with aluminium fins.



## Fans

Fans are statically and dynamically balanced according to standard ISO 1940, corresponding to class G2,5/6,3 (at the maximal rotations).

Thus, even at the maximum rotation of the fan, vibration is minimal and meets modern requirements for ventilating equipment.

Depending on air volume and required static pressure, several types of fans are used in equipment.

### Plug fans with EC/PM motor

Highly efficient in all operating areas, EC motors are available in all types of KLASIK units and correspond to the IE4 premium efficiency level. High efficiency is determined by low energy consumption, high efficiency factor and the best values of the SFP factor. By using EC fans in KLASIK units the following advantages are achieved:

- extremely high efficiency up to 94 %;
- valuable energy saving up to 30 % comparing with AC in some applications;
- integrated motor controller, no need for a frequency converter;
- very smooth and silent operation;
- long-life;
- compact construction.

PM type motors correspond to the *Super Premium Efficiency Class IE4* and ensure high efficiency in a wide operation range with reliable performance, durability, relatively low cost and electrical stability. Their operation is extremely smooth and silent, ensuring the highest efficiency, energy saving and accuracy in operation.



## Coolers and Humidifiers

### Water Air Coolers

Normally used with aluminium lamellae (spacing 2.5 or 3 mm) and copper pipes.

Maximum operating pressure – 21 bar.

Air cooler section assembled with stainless steel sloping drain tray and water trap manifold pipes are covered with a condensation-proof material.

### Direct Evaporation Air Coolers

Normally used with aluminium lamellae (spacing 2.5 or 3 mm) and copper pipes.

Maximum operating pressure – 42 bar.

Air cooler section assembled with stainless steel sloping drain tray and water trap manifold pipes are covered with a condensation-proof material. Power of direct evaporation air cooler can be divided into stages. It is necessary to indicate this when ordering.

### Adiabatic humidifiers

Application areas: museums, light industry, paper industry, textile industry, wood industry, poultry farms, data centres.

Advantages: Hygienic Certificate VDI 6022, optimal performance and minimal operating costs, wide range of sizes and performance, easy maintenance, durability.

Technical characteristics:

- Airflow from 425 to 55 000 m<sup>3</sup>/h,
- Efficiency – up to 97 % RH.





## Air Heaters

### Hot water air heaters

In standard version normally used air heaters with aluminium lamellae (spacing 3 or 4 mm) and copper pipes. Heater can be equipped with thread joint to connect freezing sensor. Maximum operating pressure – 21 bar. Maximum water temperature +130°C. Heated air temperature up to +40°C.

### Electric air heaters

Three-phase (400V/50 Hz) stainless steel heating elements are used in production. Two level protection ensures protection from overheating. Protection class IP54 in accordance with IEC 335. Heated air temperature up to +40°C.

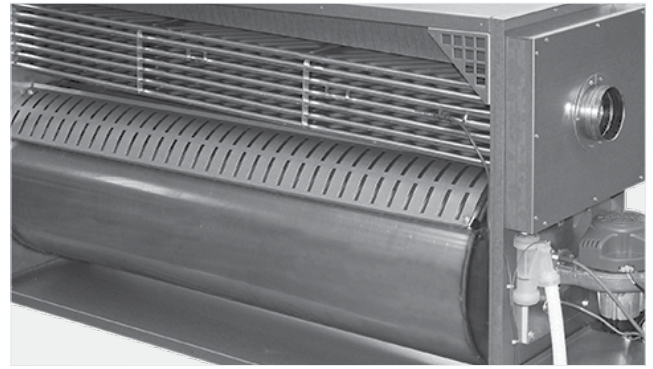

## Condensing gas heaters

Advantages of gas condensing heaters:

- there is no risk of freezing;
- no circulation pumps required;
- high temperature efficiency – up to 106 %;
- simpler installation;
- wide range from 28 to 115 kW.

Model	30	40	50	60	90	120
Nominal power, kW	28	37	48	57	89	115
Min. air flow, m³/h	2100	2750	3500	4250	6500	8500
Max. air flow, m³/h	8300	11000	14000	17000	26000	34000

## Sound attenuator section

Integrated sound attenuators or separated sound attenuators may be offered with air handling units. High performance sound attenuators as well as ventilation unit ensures high sound attenuating level and are completely insulated casing. Inside the section, a wall sound attenuator is mounted. Its elements can easily be removed through the door without using tools. The elements should be removed one by one, not as a whole block, thus providing easy dry or semi-moist cleaning for the purpose of sanitation of the ventilation system. The elements of the sound attenuator are filled with acoustic silicate cotton used for an air channel. The silicate cotton is covered with a fibreglass mat preventing cotton particles from getting into an air channel when the airflow is running at high speed. The fibreglass mat is maximally resistant to the occurrence of dust inside the air channel. Sound attenuators are available with two types of cotton: silicate cotton and polyester cotton (Dacron) with a fibre mat and polypropylene fibre covering.

## Additional accessories

KLASIK air handling units can be outdoor type. For such outdoor performance there is complete set enclosed consisting of:

- a protective roof,
- intake and exhaust air hoods,
- external grilles.

Also such additional elements are available:

- inspection window,
- sections lighting.



# Accessories for DOMEKT, VERSO Standard, RHP units



## Filters classification and standards

The introduction of the new standard ISO 16890 has established new classification based on efficiency classification system of air filters for general ventilation based upon particulate matter (PM). With the introduction of new standard, classification based on standard EN 779 becomes obsolete and familiar filter classes (M5...F9) will no longer apply. New standard classifies filters into four groups, based on particulate matter: Coarse, ePM10, ePM2,5 and ePM1. In order for a filter to fall into each category its capturing efficiency should be at least 50% of the particulate in that size range. Filter efficiency is rounded off in steps of 5%, thus tested efficiency of 58% would resolve in 55%. Filters which are not able to capture 50% of PM10 dust are classified as Coarse filters.

### Types of filters

Compact filters is characterized by longevity and a large filtering area. Filters have low-pressure losses – this in turn reduces power consumption. Filters are made of glass fabric with a cardboard frame, from environmentally friendly materials, which do not cause problems of utilization.

### Changes to the KOMFOVENT products

For the purposes of smoother transition to the new classification all KOMFOVENT filters will carry marking of the filter class based on both standards. Filter notation used in the name of air handling units will remain unchanged filters have been tested according to ISO 16890 and their efficiency is provided in the tables.

### Compact filters



Filter class EN 779:2012	Compact filters ISO 16890
G3 / G4	Coarse 75%
M5	ePM10 50%
F7	ePM2,5 65%

### Bag filters



Filter class EN 779:2012	Bag filters ISO 16890
G3 / G4	Coarse 65%
M5	ePM10 60%
F7	ePM1 60%

## Pipework package

Pipework Package Units (PPU) are used for water heater power regulation, i.e. for temperature control of supplied air by mixing hot water from a boiler with recycled water in a heat exchanger. The fully assembled pipework package is available for each size of the air handling unit where a hot water heater is used.

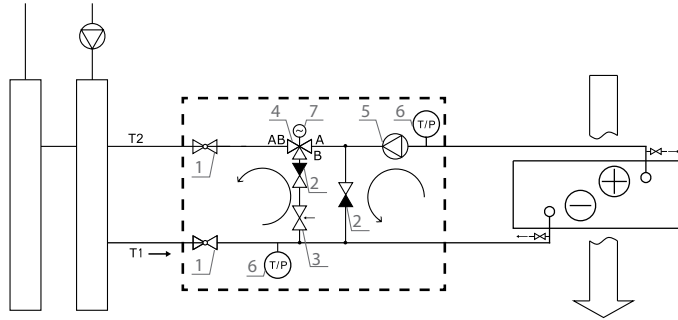

- 1. Stop valve
- 2. Return valve
- 3. Throttling valve
- 4. Control valve
- 5. Circulation pump
- 6. Manometer/ Thermometer
- 7. Actuator

Unit size	Pipework Package
R 200 V R 250 F R 300 V R 400 V/H R 450 V	PPU-HW-3R-15-0,4-W1
R 400 F R 500 V/H R 600 H R 700 V/H/F R 1000V/H	PPU-HW-3R-15-0,63-W1
R 1300 V/H/F R 2000 F	PPU-HW-3R-15-1-W2
R 1500 V/H R 1700 V/H R 3000 F	PPU-HW-3R-15-1,6-W2

Unit size	Pipework Package
R 2000 V/H R 2500 H R 3000 V/H	PPU-HW-3R-15-2,5-W2
R 5000 V/H R 7000 H	PPU-HW-3R-20-4,0-W2
R 4000 V/H	PPU-HW-3R-25-6,3-W2
CF150 F CF 200 V CF 300 V	PPU-HW-3R-15-0,4-W2
CF 250 F CF 400 V CF 500 F CF 700 V	PPU-HW-3R-15-0,4-W1*

\* For outdoor temperature -4°C

Unit size	Pipework Package
CF 700 H/F CF 1000 V/H	PPU-HW-3R-15-0,63-W1*
CF 1000 F CF 1300 V/H/F CF 1500 F CF 2500 F	PPU-HW-3R-15-1-W2*
CF 1700 V/H CF 2300 V/H	PPU-HW-3R-15-1,6-W2*
CF 3500 V/H	PPU-HW-3R-15-2,5-W2*
S 800 F S 1000 F	PPU-HW-3R-15-1,6-W2
S 1300 F S 2100 F	PPU-HW-3R-15-2,5-W2
S 3000 F	PPU-HW-3R-25-6,3-W2

## Motorized closing dampers

To protect air handling units from freezing or other external factors, motorized closing dampers must be used. They are mounted on supply and exhaust vents. There is a possibility of damper control in the automatic control system.



Unit size	Damper
R 200 V	AGUJ-M-125
R 250 F R 300 V R 400 V/H R 450 V	AGUJ-M-160
R 400 F R 600 H	AGUJ-M-200
R 500 V/H R 700 V/H/F	AGUJ-M-250
R 1000 U/V/H R 1300 U/V/H/F R 1500 U/V/H	AGUJ-M-315
R 2000 F	AGUJ-M-355
R 1700 UH/H R 2000 UH/H	SRU-M-300x400
R 1700 UV/V R 2000 UV/V	SRU-M-400x300
R 2500 H	SRU-M-700x300
R 3000 UH/H R 4000 UH/H	SRU-M-400x500
R 3000 UV/V/F R 4000 UV/V	SRU-M-500x400

Unit size	Damper
R 5000 H	SRU-M-1000x500
R 5000 V	SRU-M-1100x250
R 7000 H	SRU-M-1200x600
RHP 400 V	AGUJ-M-160
RHP 600 U	AGUJ-M-200
RHP 800 U RHP 1300 U RHP 1500 U	AGUJ-M-250
CF 250 V	AGUJ-M-125
CF150 F CF 200 V CF 300 V CF 250 F CF 400 V	AGUJ-M-160
CF 500 F CF 700 V	AGUJ-M-200
CF 700 H/F	AGUJ-M-250
CF 1000 U/H/V/F CF 1300 U/H/V/F CF 1500 F CF 1700 U/H/V	AGUJ-M-315
CF 2300 UH/H	SRU-M-300x400

Unit size	Damper
CF 2300 UV/V	SRU-M-400x300
CF 2500 F	SRU-M-700x300
CF 3500 UH/H	SRU-M-400x500
CF 3500 UV/V	SRU-M-500x400
S 650 F	AGUJ-M-160
S 800 F	AGUJ-M-200
S 1000 F	AGUJ-M-250
S 1300 F	AGUJ-M-250
S 2100 F	SRU-M-700x250
S 3000 F	SRU-M-600x400

Control system	Actuator ON/OFF	
Komfovent C4, C6	LF230	LM230
Komfovent C5	LF24	LM24

**Note:**  
LF damper actuator is with spring-return.  
LM damper actuator is without spring-return.



## Silencers

To ensure the normal noise level in the system and premises, silencers are used. There are circular and rectangular silencers of standard dimensions. An appropriate silencer can be selected using the online selection programme, which can be found on [www.komfovent.com](http://www.komfovent.com).



Unit size		Silencer type
R 200 V	A/D	AGS-125-50-600-M
	B/C	AGS-125-50-900-M
R 250 F R 300 V R 400 H/V R 450 V RHP 400 V	A/D	AGS-160-50-600-M
	B/C	AGS-160-50-900-M
R 400 F R 600 H RHP 600 U	A/D	AGS-200-50-600-M
	B/C	AGS-200-50-900-M
R 500 H/V R 700 H/V/F RHP 800 U	A/D	AGS-250-50-600-M
	B/C	AGS-250-50-900-M
R 1000 UH R 1300 UH R 1300 F R 1500 UH	A/D	AGS-315-100-900-M
	B/C	AGS-315-100-1200-M
R 1700 UH	A/D	STS-IVR3BA-600-300-700-S
	B/C	STS-IVR3BA-600-300-1250-S
R 2000 F	A/D	AGS-355-100-900-M
	B/C	AGS-355-100-1200-M
R 2000 UH R 3000 F	A/D	STS-IVR3BA-600-400-700-S
	B/C	STS-IVR3BA-600-400-1250-S
R 2500 H	A/D	STS-IVR3BA-800-300-700-S
	B/C	STS-IVR3BA-800-300-1250-S
R 3000 UH	A/D	STS-IVR3BA-600-500-700-S
	B/C	STS-IVR3BA-600-500-1250-S
R 4000 UH	A/D	STS-IVR3BA-800-500-700-S
	B/C	STS-IVR3BA-800-500-1250-S
R 5000 H	A/D	STS-IVR3BA-1000-500-700-S
	B/C	STS-IVR3BA-1000-500-1250-S
R 5000 V	A/D	STS-IVR3BA-1100-250-700-S
	B/C	STS-IVR3BA-1100-250-1250-S
R 7000 H	A/D	STS-IVR3BA-1200-600-700-S
	B/C	STS-IVR3BA-1200-600-1250-S

Unit size		Silencer type
CF 250 V	A/D	AGS-125-50-600-M
	B/C	AGS-125-50-900-M
CF150 F CF 200 V CF 250 F CF 300 V CF 400 V	A/D	AGS-160-50-600-M
	B/C	AGS-160-50-900-M
CF 500 F CF 700 V	A/D	AGS-200-50-600-M
	B/C	AGS-200-50-900-M
CF 700 H/F RHP 1300 U RHP 1500 U	A/D	AGS-250-50-600-M
	B/C	AGS-250-50-900-M
CF 1000 V/H/F CF 1300 V/H/F CF 1500 F CF 1700 V/H	A/D	AGS-315-100-900-M
	B/C	AGS-315-100-1200-M
CF 2300 V/H	A/D	STS-IVR3BA-600-400-700-S
	B/C	STS-IVR3BA-600-400-1250-S
CF 2500 F	A/D	STS-IVR3BA-800-300-700-S
	B/C	STS-IVR3BA-800-300-1250-S
CF 3500 V/H	A/D	STS-IVR3BA-800-500-700-S
	B/C	STS-IVR3BA-800-500-1250-S
S 650 F	A	AGS-160-50-600-M
	B	AGS-160-50-900-M
S 800 F	A	AGS-200-50-600-M
	B	AGS-200-50-900-M
S 1000 F S 1300 F	A	AGS-250-50-600-M
	B	AGS-250-50-900-M
S 2100 F	A	STS-IVR3BA-800-250-700-S
	B	STS-IVR3BA-800-250-1250-S
S 3000 F	A	STS-IVR3BA-600-400-700-S
	B	STS-IVR3BA-600-400-1250-S

AGS-d-h-L  
d – connecting diameter  
h – insulation's thickness  
L – silencer's length

**A** outdoor intake  
**B** supply air  
**C** extract indoor  
**D** exhaust air

## Water and direct evaporation air coolers

The air cooler is mounted on the outside of the unit.

Casing of the cooler section corresponds to the unit's casing: galvanized steel sheets with internal mineral wool insulation of 45 mm thickness. Cooler section is assembled with a drop separator and a drain tray. Cooler control function is provided in the automatic control system of the unit.

Internal fluid – R410A, water 7/12 °C.

Air temperature in/out – 30/18 °C.

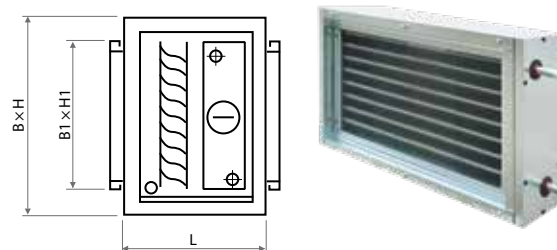

Unit size	Supply air volume, m³/h	Cooler's type	Capacity, kW	Air pressure drop*, Pa	Fluid pressure loss, kPa	BxHxL, mm	B1xH1, mm	Tubes connections, "/mm	Weight, kg
200	CF 150 CF 200 CF 250 R 250	DCF-0,2-1	1,4	25	0,4	450x400x390	300x200	½ / 22	29
		DCW-0,2-1	1,3	15	17,3			½	27
400	R 300 R 400 CF 300 CF 400	DCF-0,4-3	2,8	16	0,4	600x550x390	300x400	½ / 22	40
		DCW-0,4-3	2,6	30	30,7	505x550x390	300x400	½	33
500	R 450 R 500 CF 500	DCF-0,5-3	3,5	19	0,6	600x550x390	400x300	½ / 22	40
		DCW-0,5-3	3,3	30	52,8	600x550x390	400x300	½	35
650	R 600 S 650	DCF-0,7-5	4,5	22	0,5	705x610x390	500x400	½ / 22	49
		DCW-0,7-5	3,8	22	6,1	705x610x390	500x400	½	42
700	R 700 CF 700 CF 1000	DCF-0,7-5	4,8	22	0,6	705x610x390	500x400	½ / 22	49
		DCW-0,7-5	4,2	22	6,9	705x610x390	500x400	½	42
800	S 800 S 1000 R 1000 CF 1000	DCF-0,9-6	5,5	29	0,7	705x610x390	500x400	½ / 22	49
		DCW-0,9-6	4,8	30	6,5	705x610x390	500x400	¾	45
1200	R 1300	DCF-1,2-8	8,3	43	1,5	705x610x390	500x400	½ / 22	49
		DCW-1,2-8	7,4	46	12,8			¾	45
1400	CF 1300 S 1300 R 1500	DCF-1,4-10	9,7	74	11,5	705x610x390	500x400	½ / 22	51
		DCW-1,4-9	8,7	61	16,7			¾	45
1600	CF 1500 R 1700 CF 1700	DCF-1,6-11	11,1	78	16,4	755x610x420	500x400	½ / 22	56
		DCW-1,6-11	10,0	65	22,2			¾	46
2000	R 2000 S 2100	DCF-2,0-14	13,8	71	30,7	920x610x420	700x400	¾ / 22	65
		DCW-2,0-13	12,8	60	38			¾	57
2500	R 2000 R 2500 CF 2300 CF 2500	DCF-2,5-17	16,9	67	14,9	1080x670x420	800x400	¾ / 22	79
		DCW-2,5-17	15,5	63	16,6			1	65
3000	R 3000 S 3000	DCF-3,0-20	20,8	92	22,1	1080x670x420	800x400	¾ / 22	79
		DCW-3,0-20	18,7	102	23			1	69
4000	R 3000 CF 3500	DCF-4,0-27	26,9	94	45,6	1220x730x420	900x500	¾ / 22	97
		DCW-4,0-27	25,2	106	38,4			1	82
4500	R 4000 R 5000	DCF-4,5-31	30,3	95	35,5	1220x790x420	900x600	¾ / 22	103
		DCW-4,5-30	28,8	108	62			1	87
7000	R 7000	DCF-7,0-48-2	2x24,2	102	10,2	1500x790x480	1200x600	2x¾ / 2x22	125
		DCW-7,0-47	44,5	100	35,5	1500x790x420		1 ½	105

\* with drop eliminator.



## Ducted heater DH and cooler DHCW

For use with DOMEKT and VERSO Standard units on supply air duct. Also must be used mixing unit PPU or 2-way valve with modulating actuator. DOMEKT units are prepared for 0...10 V actuator control.

Construction:

- Galvanised steel casing;
- Cu/Al heat exchanger;
- Anti-condensation casing covering and condensate drain (only for DHCW).

Maximal pressure – 10 bar.

Maximal fluid temperature – 100°C.

Maximal air speed – 3 m/s.

Connection – ½".



Supply air volume, m <sup>3</sup> /h	Heater's type	Air temper. in/out °C	Internal fluid, water	Capacity, kW	Air pressure drop*, Pa	Fluid pressure loss, kPa	BxHxL, mm	∅D, mm	Weight, kg
450	DH-125	10/22	60/40	1,8	44	0,4	333x293x152	125	6,15
450	DHCW-125	26/18	7/12	1,4	69	5,6	333x333x164	125	11,13
450	DH-160	10/22	60/40	1,8	44	0,4	333x293x152	160	6,15
450	DHCW-160	26/18	7/12	1,4	69	5,6	333x333x164	160	11,13
900	DH-200	10/22	60/40	3,6	101	1,7	358x318x152	200	7,04
900	DHCW-200	26/18	7/12	3,0	153	26,5	363x363x164	200	12,40
900	DH-250	10/22	60/40	3,6	49	2,3	418x378x152	250	9,30
900	DHCW-250	26/18	7/12	3,1	77	37,6	423x423x164	250	15,37
900	DH-315	10/22	60/40	3,6	20	3,4	468x508x152	315	11,75
900	DHCW-315	26/18	7/12	2,8	33	2,2	557x515x164	315	21,60
1600	DH-315	10/22	60/40	6,5	58	9,8	468x508x152	315	11,75
1600	DHCW-315	26/18	7/12	5,2	90	6,8	557x515x164	315	21,60
2000	DH-315M	10/22	60/40	8,1	98	1,3	481x518x132	315	14,39
2000	DHCW-315	26/18	7/12	6,5	133	10,5	557x515x164	315	21,60
2000	DH-355	10/22	60/40	8,1	61	16,7	600x510x152	355	13,34
2000	DHCW-355	26/18	7/12	6,6	55	11,9	605x605x164	355	25,43
2600	SVK-700x400-2R	10/22	60/40	10,5	55	8,7	817x500x100	700x400	12
3400	SVK-700x400-2R	10/22	60/40	13,8	91	13,4	817x500x100	700x400	12

\* with drop eliminator.

## Electric ducted air heater (preheater)

The electric round duct heaters are intended to be used for heating of clean air in the ventilation systems. Also, heaters can be used for heating or preheating function with air handling units. The heaters can be supplied with or without installed electronic controller, with pressure and flow monitoring system. The heater case is made of aluzinc coated metal sheet, with sealing rubber for a tight connection with ventilation ducts system. Stainless steel heating elements are used in the heaters. All heaters are equipped with 2 over-heat thermostats. Automatic reset thermostat 60°C is for controlling output air temperature, manual reset thermostat 100°C is for cutoff function in case of overheating. To carry out a manual reset, a thermostat push button is installed on a heater's cover. Minimum air speed for heaters must be not less than 1,5 m/s. Standard operating range is from -30°C up to 0°C.

Type with integrated controller and flow monitoring	Heating capacity, kW	Voltage, V
EHC-125-1,0-1f SI/FC	1,0	1 ~ 230
EHC-160-1,0-1f SI/FC	1,0	1 ~ 230
EHC-160-1,5-1f SI/FC	1,5	1 ~ 230
EHC-160-2,0-1f SI/FC	2,0	1 ~ 230
EHC-200-1,0-1f SI/FC	1,0	1 ~ 230
EHC-200-1,5-1f SI/FC	1,5	1 ~ 230
EHC-200-2,0-1f SI/FC	2,0	1 ~ 230
EHC-250-1,0-1f SI/FC	1,0	1 ~ 230
EHC-250-1,5-1f SI/FC	1,5	1 ~ 230
EHC-250-2,0-1f SI/FC	2,0	1 ~ 230
EHC-250-3,0-1f SI/FC	3,0	1 ~ 230
EHC-315-2,0-1f SI/FC	2,0	1 ~ 230
EHC-315-3,0-1f SI/FC	3,0	1 ~ 230

## Accessories for unit outside installation

Air handling units can be installed outside due to thick casing insulation and easy mounting. Protective optional accessories should be used if the unit is for outside installation: roof, base frame, legs, grills, supply and exhaust hoods.

### Supply and exhaust hoods

Unit size	Type of hood for supply air	Type of hood for exhaust air
R 1000 H R 1300 H R 1500 H	G-600x430	AHIA-315
R 1700 H R 2000 H	G_755_448_00	G_755_448_10
R 3000 H R 4000 H CF 3500 H	G_540_1115_00	G_540_1115_10
R 5000 H	VERSO-30-34-00.000.2	VERSO-30-34-00.000
R 7000 H	V-40-34-00.000.2	V-40-34-00.000
CF 1000 H CF 1300 H CF 1700 H	G-600x430	AHIA-315
CF 2300 H	G_355_870_00	G_355_870_10



### Standard base frame for air handling units

Unit size	Frame type	Dimensions BxHxL, mm
R 400 H	BF_00_000_465x650	465x138x650
R 500 H	BF_00_000_590x930	590x138x930
R 500 V	BF_00_000_590x1070	590x138x1070
R 600 H	BF_00_000_520x1130	520x138x1130
R 700 H	BF_00_000_590x930	590x138x930
R 700 V	BF_00_000_590x1070	590x138x1070
R 1000 H/V R 1300 H/V R 1500 H/V	BF_00_000_852x1355	852x138x1355
R 1700 H/V R 2000 H/V	BF_00_000_852x1485	852x138x1485
R 3000 H/V R 4000 H/V	BF_00_000_1100x2100	1100x138x2100
CF 1000 H/V CF 1300 H/V CF 1700 H/V	BF_00_000_852x1810	852x138x1810
CF 2300 H/V	BF_00_000_852x2000	852x138x2000
CF 3500 H/V	BF_00_000_1100x2500	1100x138x2500



Base frame – painted RAL7035, with legs. There is a possibility to screw the adjustable legs with a rubber sole. They are assembled and ordered separately.

### Kitchen hood

(only for unit Domekt R 200)



- White colour painted
- Stainless steel

- White colour painted
- The height is only 2,6 cm

### Decorative panel

(only for unit Domekt R 200)

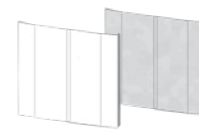

- White colour painted
- Stainless steel

### Air distribution box OSD

(only for unit Domekt R 200 for horizontal connection of ducts)



Type:  
OSD-200 VE (100 mm)  
OSD2-200 VE (125 mm)

### Outdoor grill LD

For supply and exhaust air flows' separation.



Type:  
• LD-125  
• LD-160  
• LD-200  
(black or white)

## Remote unit intensity control (OVR)

“OVR” (Eng. “Override” – ignore) function is intended for the remote unit’s control with an external accessory device. After this function is activated, the current unit’s mode can be omitted and the unit starts working according to the newly set parameters. This function has the highest priority and may operate in every mode, even when the unit is switched off. This function is possible for all units just by connecting one of the sensors listed below.

Type	Parameters
<b>Differential pressure switch DTV500</b>	Pressure range 50 – 500Pa One change-over contact (NO+NC) 250V AC, 1A Protection class IP54
<b>Motion detector PIR180</b>	Detection angle 180° Max. distance 12 m Protection class IP44
<b>Wall-mounted temperature sensor RTT</b>	Supply voltage: 24V AC/DC Temperature measuring range 0 – 50°C One change-over contact (NO+NC) 250V AC, 2A Protection class IP30
<b>Wall-mounted humidity sensor RTH</b>	Supply voltage: 24V AC/DC Relative humidity measuring range 0 – 100% One change-over contact (NO+NC) 250V AC, 2A Protection class IP30
<b>Duct-mounted humidity sensor DTH</b>	Supply voltage: 24V AC/DC Relative humidity measuring range 0 – 100% One change-over contact (NO+NC) 250V AC, 2A Protection class IP54
<b>Wall-mounted CO<sub>2</sub> sensor RTC</b>	Supply voltage: 24V AC/DC CO <sub>2</sub> measuring range 0 – 2000 ppm One change-over contact (NO+NC) 250V AC, 2A Protection class IP30
<b>Duct-mounted CO<sub>2</sub> sensor DTC</b>	Supply voltage: 24V AC/DC CO <sub>2</sub> measuring range 0 – 2000 ppm One change-over contact (NO+NC) 250V AC, 2A Protection class IP54
<b>Wall-mounted air quality sensor RTQ</b>	Supply voltage: 24V AC/DC Air quality measuring range 0 – 2000 ppm One change-over contact (NO+NC) 250V AC, 2A Protection class IP30
<b>Duct-mounted air quality sensor DTQ</b>	Supply voltage: 24V AC/DC Air quality measuring range 0 – 2000 ppm One change-over contact (NO+NC) 250V AC, 2A Protection class IP54

## Unit PC control (Ping2) for C4 controller



An option to manage and control units by computer, when connected to the PC network or Internet. Network module PING2 is intended for connection of air handling units KOMFOVENT to the computer network (*Ethernet*) or another network (RS-485).

## Air quality control (AQ)

AQ ventilation intensity control option according to the external sensor signal. Provides ventilation intensity correction, according to the increased CO<sub>2</sub>, humidity level, etc. A different AQ function may be set depending on the sensor type, therefore, the intensity of the unit will be regulated accordingly. User can activate this function anytime according to the demand and can also observe the premise’s air quality on the panel. This function is possible for all units just by connecting one of the sensors listed below.

Type	Parameters
<b>Wall-mounted temperature sensor RST</b>	Supply voltage: 24V AC/DC Temperature measuring range 0 – 50°C Output signal 0...10V DC Protection class IP30
<b>Wall-mounted humidity sensor RSH</b>	Supply voltage: 24V AC/DC Relative humidity measuring range 0 – 100% Output signal 0...10V DC Protection class IP30
<b>Duct-mounted humidity sensor DSH</b>	Supply voltage: 24V AC/DC Relative humidity measuring range 0 – 100% Output signal 0...10V DC Protection class IP54
<b>Wall-mounted CO<sub>2</sub> sensor RSC</b>	Supply voltage: 24V AC/DC CO <sub>2</sub> measuring range 0 – 2000 ppm Output signal 0...10V DC Protection class IP30
<b>Duct-mounted CO<sub>2</sub> sensor DSC</b>	Supply voltage: 24V AC/DC CO <sub>2</sub> measuring range 0 – 2000 ppm Output signal 0...10V DC Protection class IP54
<b>Wall-mounted air quality sensor RSQ</b>	Supply voltage: 24V AC/DC Air quality measuring range 0 – 2000 ppm Output signal 0...10V DC Protection class IP30
<b>Duct-mounted air quality sensor DSQ</b>	Supply voltage: 24V AC/DC Air quality measuring range 0 – 2000 ppm Output signal 0...10V DC Protection class IP54

## Variable air volume control (C5 / C6)



Unit supplies and exhausts the air volume correspondingly to the ventilation requirements in different premise. Because of frequently changing ventilation demands, such air volume’s maintenance mode signally reduces unit’s exploitation costs. VAV function is possible for all units.

## Electric wiring of air-handling units

When the air handling unit is installed, the user should just connect it to the mains power supply and install one temperature sensor in the supply air duct, and in case of need extend the connecting cable of the control panel.

The units with a hot water air heater are provided with extra connecting cables for a heating damper drive, a pump, and an air damper drive. If the air handling unit voltage is ~230 V;

50 Hz it is necessary to install the socket with grounding of corresponding capacity. If the voltage is ~400 V; 50 Hz, the cable of electrical power supply is connected to the main switch, which is located on the unit's outside wall.

The air handling units power supply cable types are specified in the table.

Unit size	Power supply cable
R 200 R 250 R 300 R 400 R 450 R 500 R 600 R 700	3×1,5 mm <sup>2</sup>
R 1000 E	5×1,5 mm <sup>2</sup>
R 1300 E R 1500 E R 1700 E R 2000 E R 2500 E R 3000 E R 5000 W R 7000 W	5×2,5 mm <sup>2</sup>
R 4000 E R 5000 E	5×6 mm <sup>2</sup>
R 1000 W R 1300 W R 1500 W R 1700 W R 2000 W R 2500 W	3×1,5 mm <sup>2</sup>
R 3000 W R 4000 W	5×1,5 mm <sup>2</sup>
RHP 400 RHP 600	3×1,5 mm <sup>2</sup>
RHP 800	5×2,5 mm <sup>2</sup>
RHP 1300 RHP 1500	5×4 mm <sup>2</sup>

Unit size	Power supply cable
CF150 CF 200 CF 250 CF 300 CF 400 CF 500 CF 700	3×1,5 mm <sup>2</sup>
CF 1000 E CF 1300 E CF 1500 E CF 1700 E CF 2300 E	5×2,5 mm <sup>2</sup>
CF 2500 E	5×4 mm <sup>2</sup>
CF 1300 W CF 1500 W CF 1700 W CF 2300 W	3×1,5 mm <sup>2</sup>
CF 3500 W	5×1,5 mm <sup>2</sup>
S 650 E/3	3×2,5 mm <sup>2</sup>
S 650 E/6	5×1,5 mm <sup>2</sup>
S 800 E/6 S 800 E/9 S 1000 E/9 S 1300 E/9	5×2,5 mm <sup>2</sup>
S 1000 E/15 S 1300 E/15 S 2100 E/15	5×6 mm <sup>2</sup>
S 2100 E/22,5	5×10 mm <sup>2</sup>
S 800 W S 1000 W S 1300 W S 2100 W	3×1,5 mm <sup>2</sup>
S 3000 W	5×1,5 mm <sup>2</sup>

Control panel	Connection cable for control panel (10 m)
C6.1, C6.2, C5.1, C4.1	4×0,22 mm <sup>2</sup>

## Unit marking and ordering samples:

### DOMEKT-R-300-V-L1-F7/M5-C6-L/A

① ② ③ ④ ⑤ ⑥ ⑦ ⑧

- ① Series: **DOMEKT**
- ② Type of heat exchanger: **R** – rotary; CF – counterflow; S – supply unit
- ③ Unit size: 150, 200, 250, **300**, 400, 450, 500, 600, 650, 700, 800, 1000
- ④ Duct connection: **V** – vertical; H – horizontal; F – ceiling
- ⑤ Inspection side: R1; R2; **L1**; L2
- ⑥ Air filter class: **F7/M5**; M5/M5
- ⑦ Controller: **C6**, C6M, C4
- ⑧ Heat exchangers characteristic: **L/A**; L/AZ; ER (enthalpy counterflow plate heat exchanger)

### VERSO-R-1300-UH-E-L1-F7/M5-C5.1-SL/A

① ② ③ ④ ⑤ ⑥ ⑦ ⑧ ⑨

- ① Series: **VERSO**
- ② Type of heat exchanger: **R** – rotary; CF – counterflow; S – supply unit
- ③ Unit size: 1000, **1300**, 1500, 1700, 2000, 2100, 2300, 2500, 3000, 3500, 4000, 5000, 7000
- ④ Duct connection: **UH** – universal/horizontal; UV – universal/vertical; H – horizontal; V – vertical; F – ceiling
- ⑤ Heater type: **E** – electric; W – water; CW – water cooler; DX – freon cooler
- ⑥ Inspection side: R1; R2; **L1**; L2
- ⑦ Air filter class: **F7/M5**
- ⑧ Control system with panel: **C5.1**
- ⑨ Rotary characteristic: L/A; **SL/A**; L/AZ

### VERSO-RHP-600-3.7/3-UH-L1-F7/M5-C5.1-L/AZ

① ② ③ ④ ⑤ ⑥ ⑦ ⑧ ⑨

- ① Series: **VERSO**
- ② Type: **RHP**
- ③ Unit size: 400, **600**, 800, 1300, 1500
- ④ Heating / cooling capacity: **3.7/3**
- ⑤ Duct connection: **UH** – universal/horizontal; UV – universal/vertical; V – vertical
- ⑥ Inspection side: **L1**; L2; R1
- ⑦ Air filter class: **F7/M5**; F7/F7; M5/M5
- ⑧ Control system with panel: **C5.1**
- ⑨ Rotary characteristic: **L/AZ**

### Inspection side:

← supply air

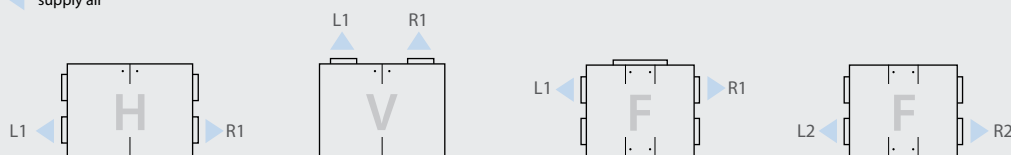

Inspection side is determined by the supply air direction, looking at the unit from the user's side.

# Verso Pro 2

Quality approach to professional ventilation

## T2 / TB1 / L1 / D1

The advanced PVC profile technology allows us to achieve the best casing characteristics.

### More convenient than ever before

A specially designed automation box ensures easy connection and airtightness.

### 1.6 million combinations

The modular design of the units enables a wide range of modeling capabilities.

**NEW**  
2019 2Q



**komfovent**<sup>®</sup>



## UAB KOMFOVENT

Ozo str. 10  
LT-08200 Vilnius  
Lithuania  
[info@komfovent.com](mailto:info@komfovent.com)  
[www.komfovent.com](http://www.komfovent.com)

2018-10